

AN6164K, AN6164S

Constant Voltage Drive Speech Network Circuits

Overview

The AN6164K and AN6164S are ICs for constant voltage drive type speech networks.

They incorporate a speaker amplifier and attenuator and suitable for the car telephone and business telephone.

Features

- Capable of interfacing with the piezo-electric receivers and dynamic receivers
- Capable of interfacing with the piezo-electric transmitters and ECM type transmitters
- Balance input for both receiver and transmitter system in order to prevent mixture of humming noises
- Capable of muting each amplifier by external control
- Built-in attenuator circuit in the receiver system to allow 7-step adjustment of attenuation (0 to -30dB) with the switch 3 terminals
- Built-in standby circuit for the power supply to allow low power consumption ; supply current of 15 μ A or less in the standby mode

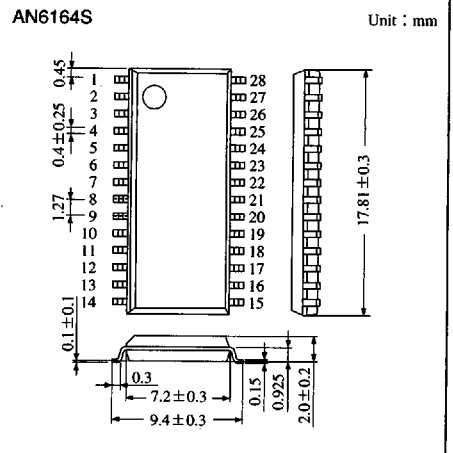
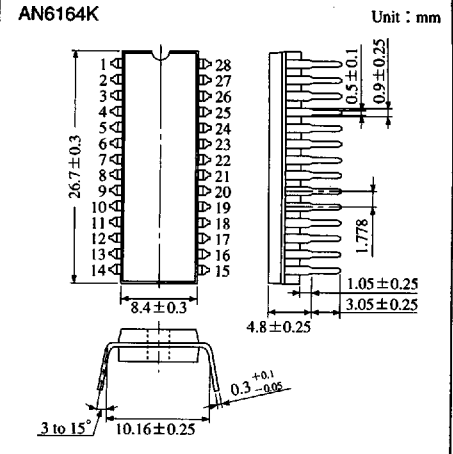

Block Diagram

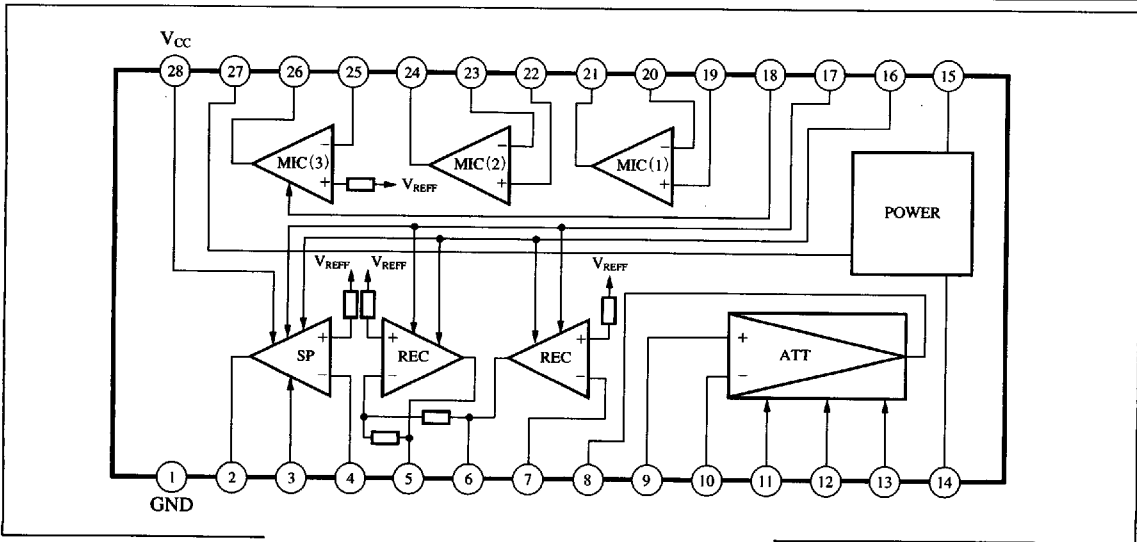

6932852 0013063 7&T

■ Absolute Maximum Ratings (Ta=25°C)

Parameter	Symbol	Rating	Unit
Supply voltage	V _{CC}	-0.3 to +14.4	V
Supply current	I _{CC}	1	A
Power dissipation	P _D	380*	mW
Operating ambient temperature	T _{opr}	-20 to +75	°C
Storage temperature	T _{stg}	-55 to +125	°C

* Operating ambient temperature Ta = 75°C, mounted onto the glass epoxy PCB (50×50×1.2mm)

■ Recommended Operating Range (Ta=25°C)

Parameter	Symbol	Range
Operating supply voltage range	V _{CC}	4.5 to 8V



■ Electrical Characteristics (V_{CC}=5V, f=1kHz, Ta=25°C)

Parameter	Symbol	Condition	min	typ	max	Unit
Current consumption (SP MODE)	I _{CC} (SP)	Measure current consumption at V _{CC} =8V and at the speaker mode.	5	11	17	mA
Current consumption (STANDBY MODE)	I _{st}	Measure current consumption at V _{CC} =8V and at the standby mode.	—	—	15	μA
Microphone amplifier (1) open circuit gain	G _v (M1)	Input a signal to the Pin⑨ and measure the open circuit gain at the Pin②.	55	—	—	dB
Microphone amplifier (1) output level	V _O (M1)	Measure a distortion factor at the Pin② at gain=20 dB, load=600Ω, and output=-2dB.	—	—	5	%
Microphone amplifier (1) noise output voltage	V _{no} (M1)	Measure the noise level with DIN/AUDIO at R _g =2.2kΩ and gain=20 dB.	—	-90	-80	dBV
Receiver amplifier gain	G _v (REC)	Set the gain to 20 dB with an external resistor and measure the gain at V _{in} =-25 dBV.	18	20	22	dB
Receiver amplifier output level	V _O (REC)	Measure a distortion factor at gain=20 dB, load=100Ω, and output=0 dBV.	—	—	5	%
Receiver amplifier noise output voltage	V _{no} (REC)	Measure the noise level with DIN/AUDIO at R _g =2.2kΩ and gain=20 dB.	—	-80	-70	dB
ΔATT (1)	ΔATT (1)	Input a signal (-10 dBV) to the Pin⑨ and measure the output level. Ground the Pin①.	-7	-5	-3	dB
ΔATT (2)	ΔATT (2)	Input a signal (-10 dBV) to the Pin⑨ and measure the output level. Ground the Pin②.	-12	-10	-8	dB
ΔATT (3)	ΔATT (3)	Input a signal (-10 dBV) to the Pin⑨ and measure the output level. Ground the Pin③.	-17	-15	-13	dB
ATT	ATT	Input a signal (-10 dBV) to the Pin⑨ and measure the output level.	-2	0	+2	dB
Speaker amplifier open circuit gain	G _v (SP)	Input a signal to the Pin④ and measure the open circuit gain of the Pin②.	40	—	—	dB
Speaker amplifier output level	V _O (SP)	Measure a distortion factor at the Pin② at gain=26 dB, load=16Ω, and output=0 dBV.	—	—	5	%
Speaker amplifier noise output voltage	V _{no} (SP)	Measure the noise level with DIN/AUDIO at R _g =2.2kΩ and gain=26 dB.	—	-85	-75	dBV
Control voltage (H)	V (H)		2	—	V _{CC} +0.3	V
Control voltage (L)	V (L)		-0.3	—	+0.5	V
Control pin suction current	I _{cont}	Measure a current flowing out when the control pin is ground.	—	—	20	μA

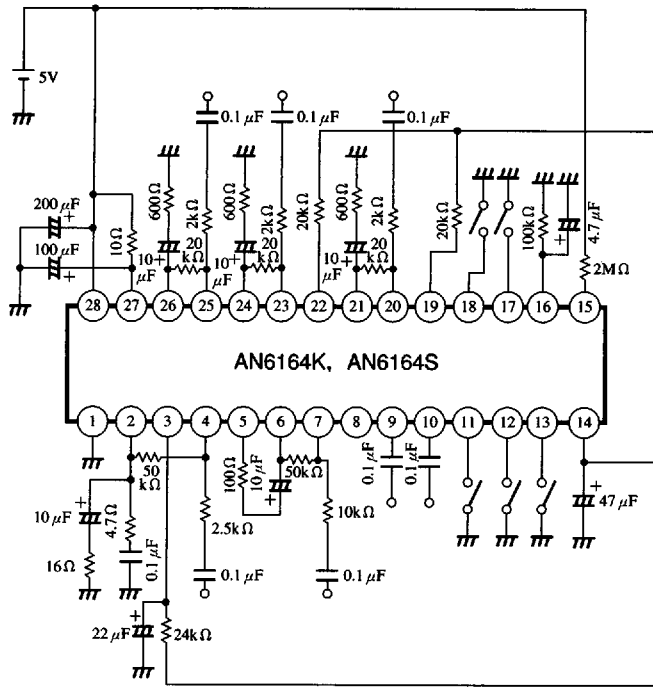
■ Application Circuit



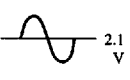
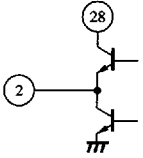

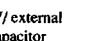
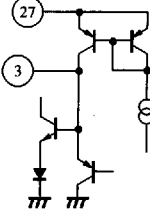
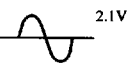
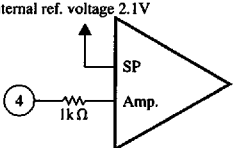



■ Pin Descriptions

Pin No.	Pin name	Typical waveform	Description	Equivalent circuit
1	GND	— DC 0V	Ground pin. Connect to the ground potential.	—
2	SP output	 2.1 V	Speaker output pin. Outputs a receives signal to the speaker.	
3	SP cont	W/o external capacitor:  W/ external capacitor:  — DC	Speaker control pin. Connect to GND through the 22 μF electrolytic capacitor.	
4	SP input	 2.1V	Speaker signal input pin. Inputs a speaker signal through the coupling capacitor.	Internal ref. voltage 2.1V 

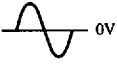
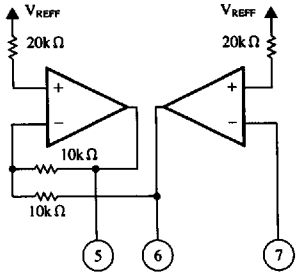
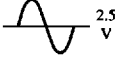
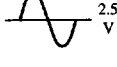
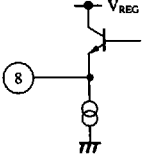
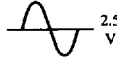
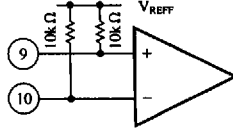
6932852 0013065 552

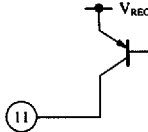
Panasonic

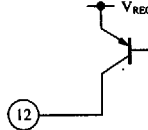

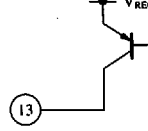
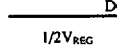
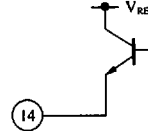
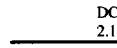
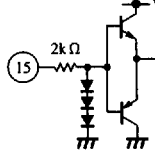



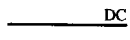
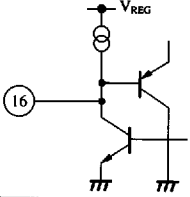
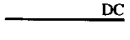
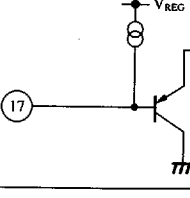

■ Pin Descriptions (cont.)

Pin No.	Pin name	Typical waveform	Description	Equivalent circuit
5	RO-2		Receiver output pins 2 and 1. Connects to the receiver through the coupling capacitor. The receiver connected is a 100Ω dynamic type or 1 kΩ piezo-electric type.	
6	RO-1			
7	REC input		Receiver input pin. Inputs a receiver signal through the coupling capacitor.	
8	ATT output		Attenuator output pin. Connects to the receiver amplifier and speaker amplifier through the coupling capacitor.	
9	ATT (+) input		Attenuator positive input pin and negative input pin. Inputs a receiver signal through the coupling capacitor.	
10	ATT (-) input			
11	ATT cont (1)		Attenuator control pin 1. The receiver gain is attenuated 5 dB by setting this pin to the L level.	
12	ATT cont (2)		Attenuator control pin 2. The receiver gain is attenuated 10 dB by setting this pin to the L level.	
13	ATT cont (3)		Attenuator control pin 3. The receiver gain is attenuated 15 dB by setting this pin to the L level.	
14	V _{REF}		Reference pin. Connects to GND through the electrolytic capacitor. The current obtainable from this pin is 7mA.	
15	STANDBY		Standby pin. Connects to the Pin [Ⓢ] through a resistor (2MΩ). The standby mode is set by setting this pin to the Low level.	

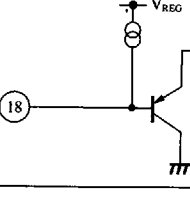
ICs for Telephone

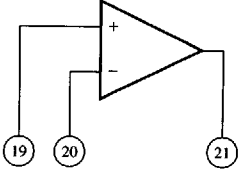

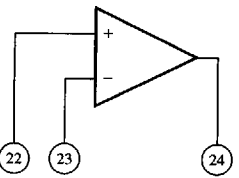

■ 6932852 0013066 499 ■

Pin Descriptions (cont.)

Pin No.	Pin name	Typical waveform	Description	Equivalent circuit
16	V _{CC} cont		Power rise control pin. Connects to GND through the electrolytic capacitor (4.7 μF) and resistor (100k Ω).	
17	REC/SP		Receiver/speaker selector pin. The speaker mode is selected by setting this pin to the H level, and receiver mode by setting to the L level.	
18	MIC mute		Microphone mute pin. Controls ON/OFF of the microphone (3) amplifier. Muted by setting this pin to the L level.	
19	MIC-1 input		Microphone (1) positive and negative input pins. Connects the ECM type microphone through the coupling capacitor.	
20	MIC-1 input			
21	MIC-1 output		Microphone (1) output pin. Capable of driving a 600 Ω load.	
22	MIC-2 input		Microphone (2) positive and negative input pins. Connects the ECM type microphone through the coupling capacitor.	
23	MIC-2 input			
24	MIC-2 output		Microphone (2) output pin. Capable of driving a 600 Ω load.	

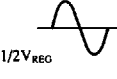
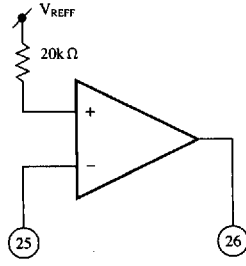
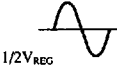
6932852 0013067 325

Pin Descriptions (cont.)

Pin No.	Pin name	Typical waveform	Description	Equivalent circuit
25	MIC-3 input		Microphone (3) input pin. Connects to the microphone (1) or microphone (2) through the coupling capacitor.	
26	MIC-3 output		Microphone (3) output pin. Capable of driving a 600Ω load.	
27	V _{REG}		Stabilized supply voltage pin. Connects to GND through the electrolytic capacitor.	
29	V _{CC}		Supply voltage pin. Connects to GND through the electrolytic capacitor.	

Supplementary Descriptions

Receiver Attenuator

☆About receiver attenuator

Since the AN6164K and AN6164S incorporate the attenuator circuit in the receiver system, you can adjust an amount of attenuator in 7 steps with the 3 pins, ⑪, ⑫, and ⑬.

The logic table is shown below.

Receiver Attenuation Amount

⑪	⑫	⑬	Attenuation amount (dB)
H	H	H	0
L	H	H	-5
H	L	H	-10
H	H	L	-15
L	H	L	-20
H	L	L	-25
L	L	L	-30
L	L	H	-15

■ Characteristics Curve

Microphone Amp. I/O Distortion Factor Characteristics

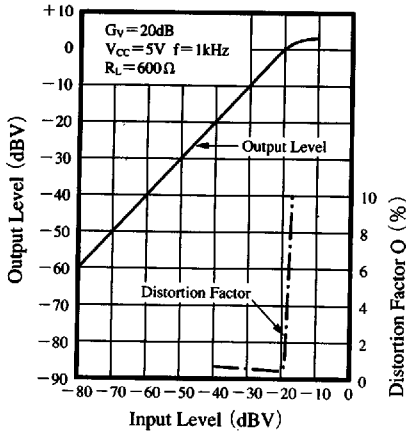

Receiver Amp. I/O Distortion Factor Characteristics

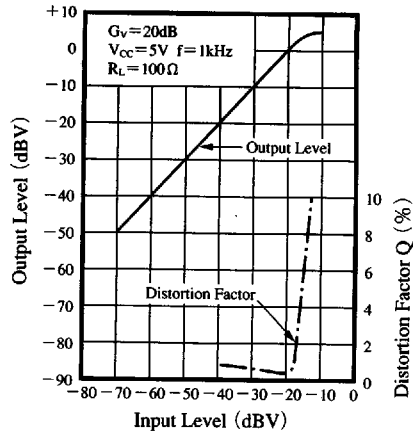

Speaker Amp. I/O Distortion Factor Characteristics

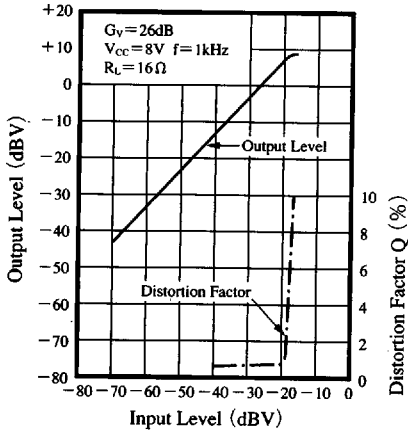

This datasheet has been downloaded from:

www.DatasheetCatalog.com

Datasheets for electronic components.



LittleDiode supplies new, hard to find or obsolete electronic components and semiconductors all over the world.

With over two million different components listed you are sure to find the part you need.

Feel free to visit us today at our online store:

LittleDiode.com

Looking forward to providing you with the best possible service.