

CHOOSING AN ITAxX REQUIRES A SYSTEM APPROACH

CH - Politano

INTRODUCTION.

Destined for the protection of data transmission lines, each one of these components corresponds to a particular application. Therefore, one no longer chooses an ITAxX - type protection as he did a Transil diode. In order to accurately select the correct component, one must take into account the entire system and analyse the following points:

- * against what type of disturbances do we want protection?
- * what Transil array configuration do we need (number of I/O, voltage of the line signal)?
- * what type of interface circuit are we protecting, and what are the destruction limits?

Once this step is done, the only thing left to do is to define the adapted Transil array. To help the user, a detailed description of the characteristics and the functioning mode of the ITAxX arrays is required.

1) The protection level of the ITAxX :

The protection of electronic and computer systems against ESD and EOS disturbances is regulated by numerous standards, such as IEC801-xxx, Mil Standard, etc. Within one standard, the protection levels change in function of the application.

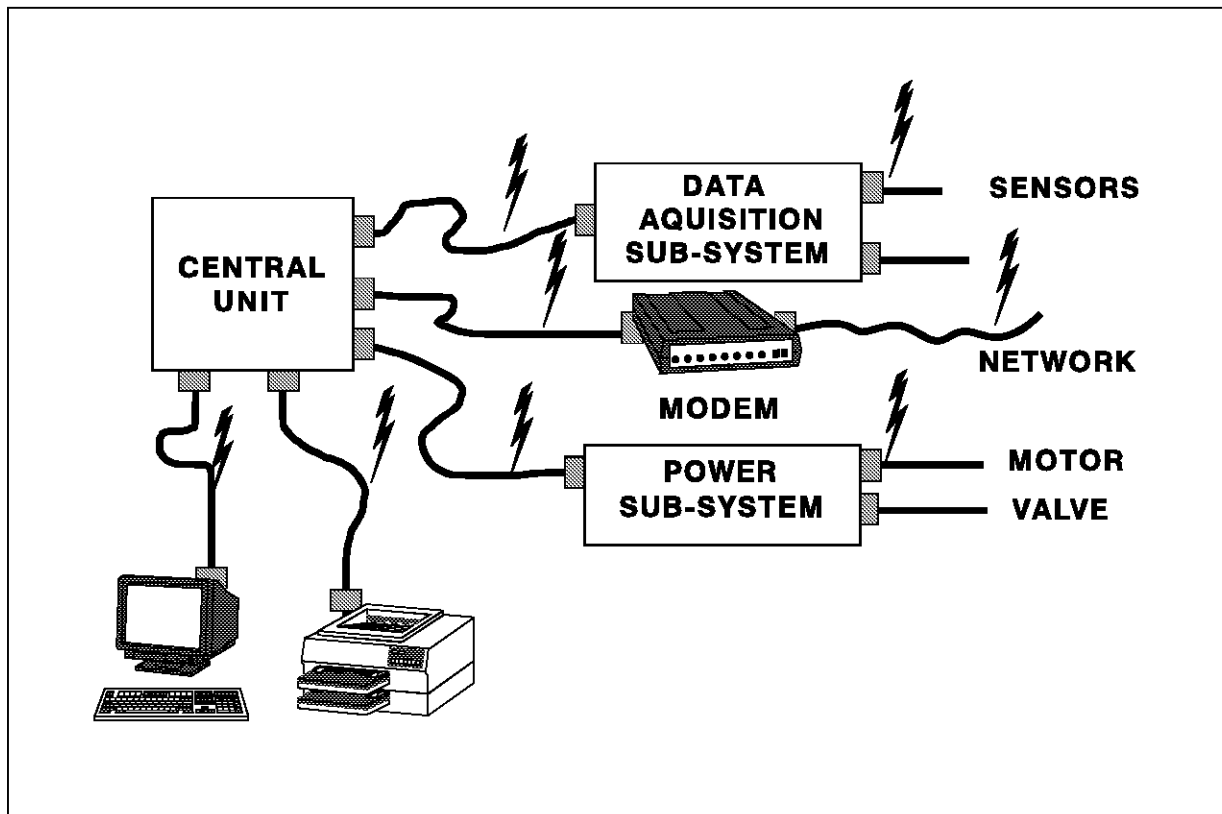

APPLICATION NOTE

SGS-THOMSON's objective in developing this range of Transil arrays (ITAx_{xx}) was to propose solutions that correspond exactly to these demands (see Annex 2: Applicable Protection Standards ...). These components are designed in order to protect against over-voltages resulting from ESD or EOS that disturb data transmission lines and for which the characteristics are stated below:

- ESD discharges have very little energy. However, they are very rapid (5/30 ns waves) and present very high voltage peaks, around 15 KV. The component must assure an efficient protection in dynamic behavior. Low clamping voltage levels ($V_{CL} < 30\text{ V}$) must be maintained in the presence of very fast transients with rise times such as 10A/ns. In this case, the performance of the protection device is not linked to the silicon but to the structure of the connections and the track lay-out of the PC board.

- The EOS are longer over-voltages (1.2/50 μs waves) with voltage peaks of 500 volts to 1 KV. Because these disturbances are powerful, the protection device must be able to dissipate the power in the silicon in order to guarantee low clamping voltage levels.

2) ITAx_{xx}, a reliable protection against ESD :

It has been shown that in the presence of ESD-type disturbances, standard protection devices (axial and even SMD diodes) only guarantee a protection level of about a few hundred volts. We still find at the lead level of the sensitive component to be protected the clamping voltage (V_{cl}) to be 10 to 30 volts, and especially an over-voltage created by the parasitic inductances ($L di/dt$) which can reach several hundreds of volts. Figure 3 illustrates this behavior.

Figure 3 : Protection Against ESD

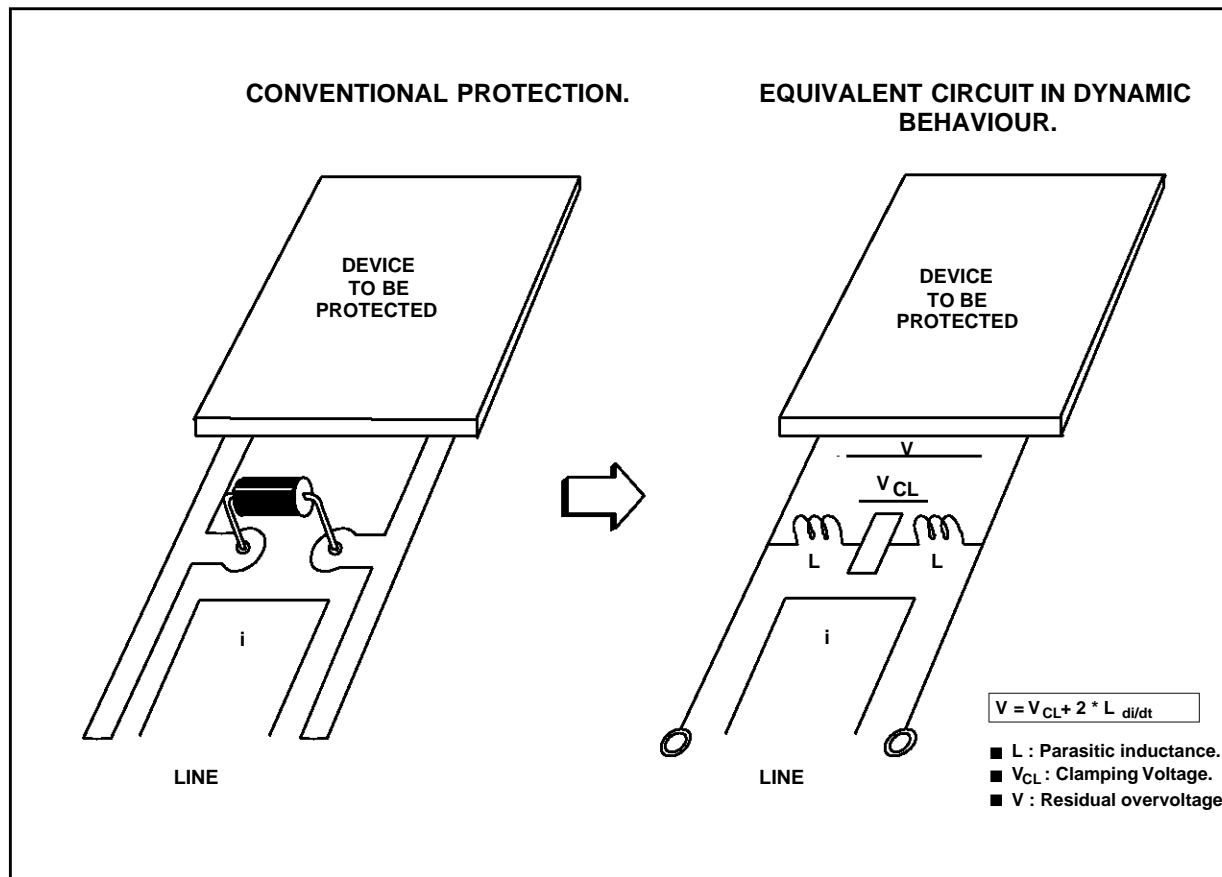

Aware of this problem, the manufacturers of interface circuits have proposed components with auto-protected I/O's up to 1 to 2 kV. But in the case of long lines which are heavily exposed to disturbances, this precaution is not enough and, therefore, requires the use of specific ESD protection devices.

The ITAxxB3 and ITAxxU3, which offer 8-transil functions in an SO 20 package, have been especially designed for this application. The internal wiring is based on a 4-point structure which allows the isolation of the input from the output, guaranteeing a reliable protection with clamping voltages less than 30 volts. This assures a real protection of the line interfaces.

In order to achieve such performance from these components, some recommendations about PCboard mounting must be given.

Figure 4 shows what type of lay-out must be used in order to take advantage of the 4-point structure of the ITAxxB3 and ITAxxU3. With this configuration, each data line passes through the protection device. In this case, it acts as an interface between the cable and the circuit to be protected and guarantees an isolation between its inputs and outputs.

The ESD wave is deviated across the input of the protection device. Therefore, the circuit to be protected is no longer exposed to the Ldi/dt generated by the parasitic inductances of the wiring.

Figure 4 : 4 - Points Structure (ITAxxB)

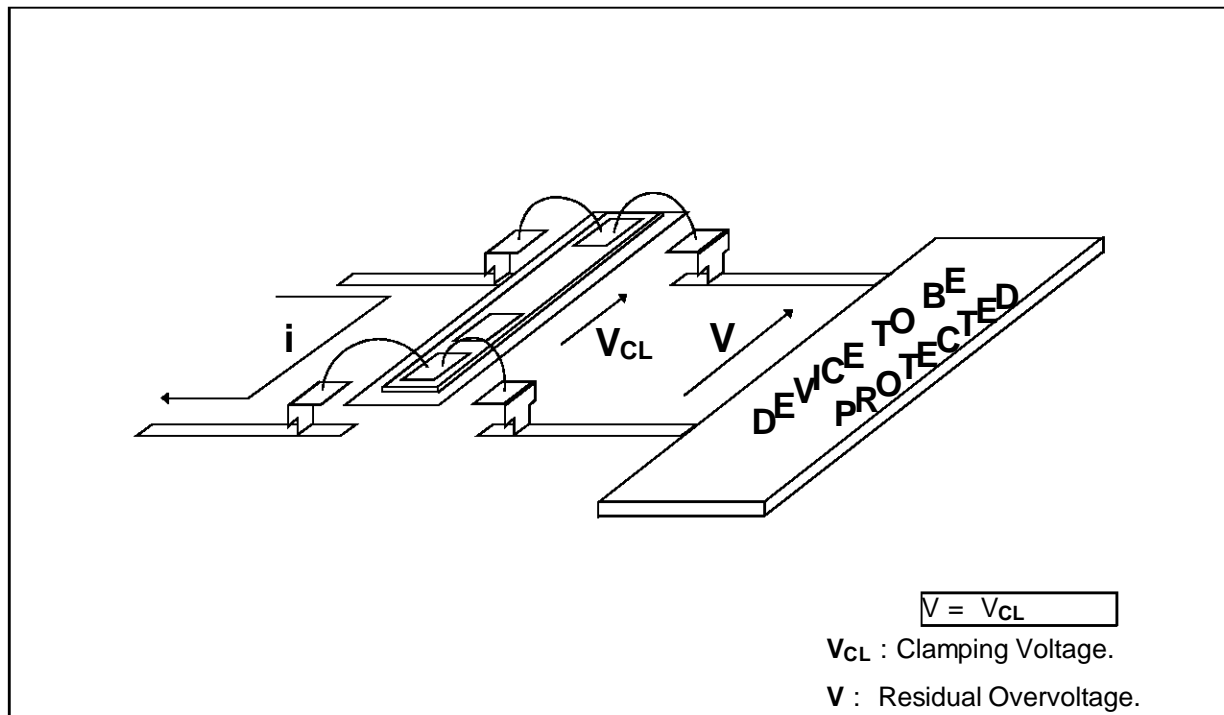

3) The ITAxx, an efficient protection against EOS :

Due to their monolithic structure which allows to optimize the active surface of the silicon, these products have a dissipation capability equal to that of discrete components. These devices can be considered as real protection against

industrial disturbances (EOS) of the 1.2/50 μ sec type by guaranteeing clamping voltages at high currents well under the maximum ratings of line interface circuits.

For example, these characteristics (V_{CL} , I_{pp}) are given for several part types in the table below:

APPLICATION NOTE

Device	VBR	I _{pp} max 8/20 μsec	VCL @ I _{pp} 8/20 μsec	VCL @ I _{pp} 8/20 μsec
ITA6V1U3	6V1	40 A	10V at 10 A	12V at 25 A
ITA6V1M3	6V1	40 A	12V at 10 A	14V at 25 A
ITA18B1	18	40 A	25V at 10 A	28V at 25 A
ITA25B3	25	40 A	31V at 10 A	36V at 25 A

Note that the maximum dissipation capability is equal to $I_{pp} = 40 \text{ A} @ 8/20 \mu\text{sec}$ for all configurations no matter what the voltage is. The objective is to meet the protection standards concerning industrial disturbances applied to data transmission lines, which require to withstand the same level of energy no matter the application. This is reflected in the standard IEC801-5.

4) The choice and use of the ITAxx :

All of the ITAxx monolithic arrays have been developed with the same basic concept of the integration of uni-directional functions, for uni-directional as well as bi-directional products (see Annex 1: Product Range - Configurations).

The uni-directional products (ITAxxU series) are achieved with a network of common-anode Transil which is similar to the discrete solution lay-out.

The bi-directional devices (ITAxxB series) are created with a network of common-cathode Transil which require special attention for their usage.

Figure 5 below explains the functional schematic diagram obtained with a bi-directional Transil array (ITAxxB series).

Figure 5 : The use of a Bi-Directional Transil Array (ITAxxB series)

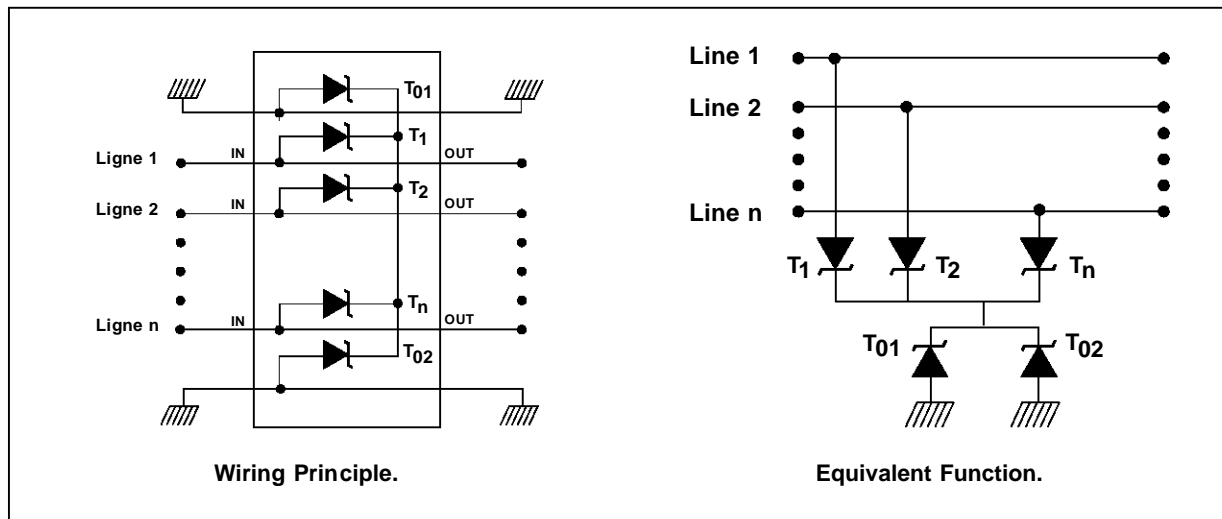

a) Basic Principle :

Connect two Transil to ground (T01 and T02). This precaution doubles the current capability in relation to ground, thus allowing to support the maximum ratings ($I_{pp} = 40 \text{ A}, 8/20 \mu\text{sec}$) on two wires at the same time. This guarantees a large safety margin, because when a disturbance occurs, it spreads out over all the wires.

b) Choice of the break-down voltage (V_{BR}) of the ITAxxB :

In the case of symmetrical signals ($\pm V_{LINE}$), a bi-directional Transil array with a break-down voltage (V_{BR}) greater than the maximum differential voltage between the 2 wires must be used.

Figure 6 helps to understand the break-down voltage (V_{BR}) calculation:

$$V_{BR} > 2 * V_L$$

Each line is protected in the common mode at a voltage equal to the V_{BR} , and the line signals are not clamped in the differential mode.

Figure 6 : Calculation of the Breakdown Voltage (V_{BR}).

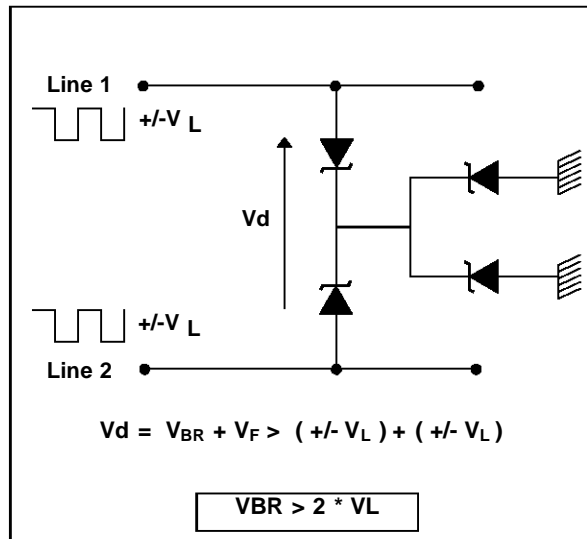

c) Examples of the use of bi-directional transil arrays.

Maximum Line Signals	ITAxxB Solutions
+/- 5 V	ITA10Bx
+/- 9 V	ITA18Bx
+/-12 V	ITA25Bx

5) An ITAxX assures protection, even after its destruction :

When a disturbance occurs whose energy is greater than the dissipation capability of the component, the destruction mode is a short-circuit.

This behavior, linked to the physical laws of silicon but also to an adequate wiring, assures constant protection, even after destruction. Additionally the line failure detection is immediate.

6) Use of transil arrays as an EMI filter :

By using these transil arrays, the EMI filter function is offered "for free". The combination of the junction capacitance (from 500 to 1000 pf) with the parasitic inductances of the PC board tracks ($L = 10$ nH/cm) creates an EMI filter whose attenuation can satisfy applications with low exposure levels such as centronics connection in printers.(See Fig. 7)

Figure 7 : The use of Transil Arrays as Emi Filter

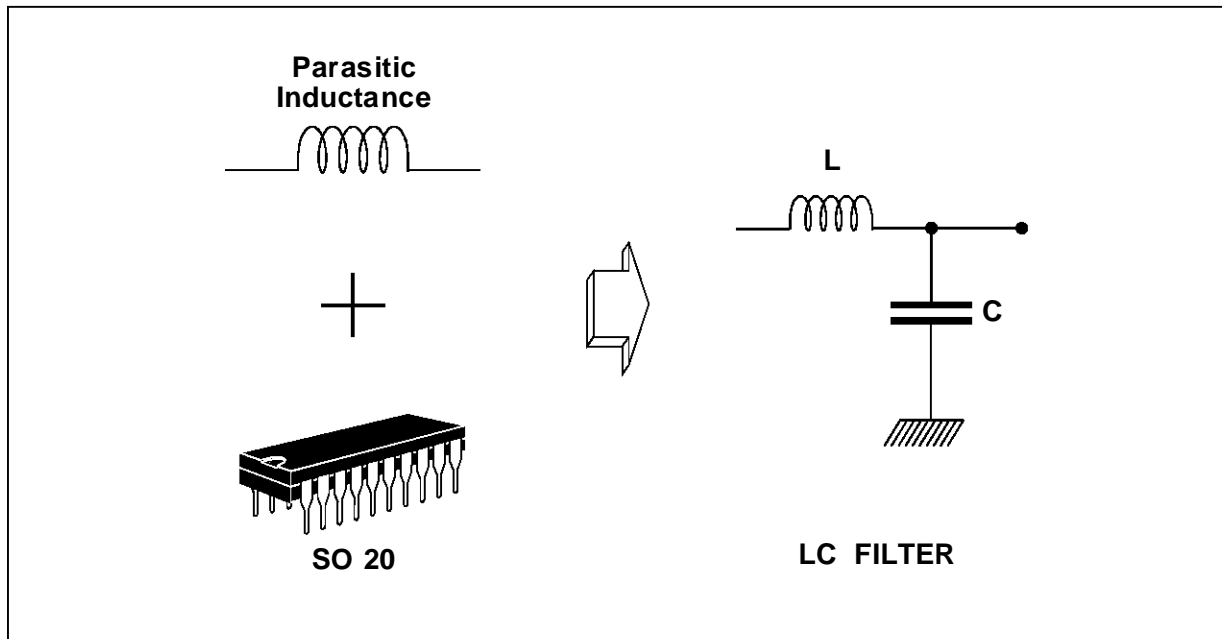

APPLICATION NOTE

Here is an example of a calculation of attenuation using the following hypothesis:

- * L = 80 nH (equal to an 8-cm track)
- * C = 1100 pF (ITA6U1M3 type)

This gives a cut-off frequency of $F_0 = 17$ MHz and an attenuation equal to 28 dB at 80 MHz.

7) The ITAxx assures a multi-channel protection without disturbing the signal transmissions.

The strong concentration of protection functions included in the ITAxx required the adoption of a new monolithic technology. This concept, characterized by a high density of lines, generates parasitic capacitances between adjacent channels. The trial testing done by our application laboratory showed that these "crosstalk" disturbances were not sufficient enough to disrupt the most widely used numeric data transmission lines.

An example of this would be the RS232 connection ($V_L = \pm 12V$) where experimentation

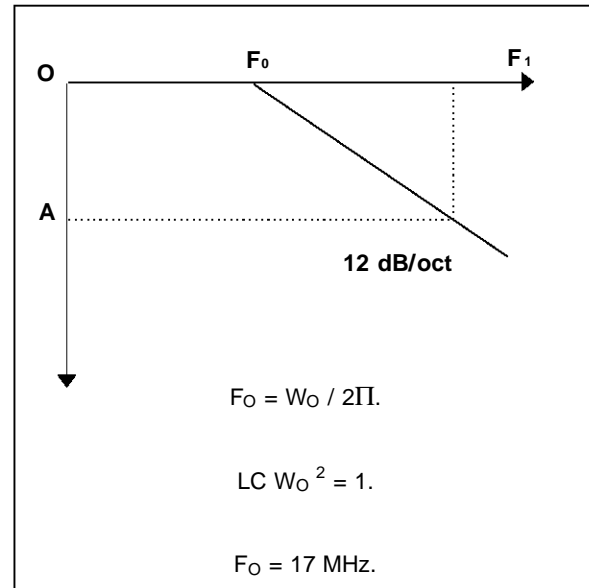

has allowed the evaluation of the parasitic signals induced on the adjacent lines. This has showed them to be at $\pm 2.5V$ max (Fig. 8) for a duration of 0.4 μs (Fig. 9).

Figure 8 : Inter-Line Interference (amplitude)

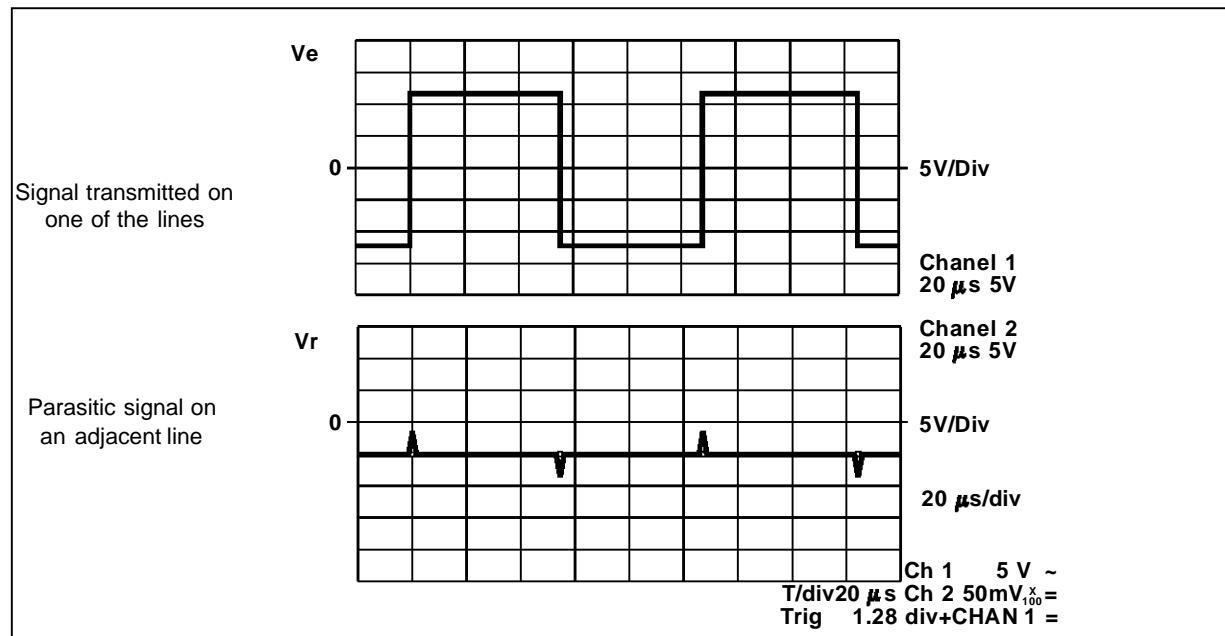
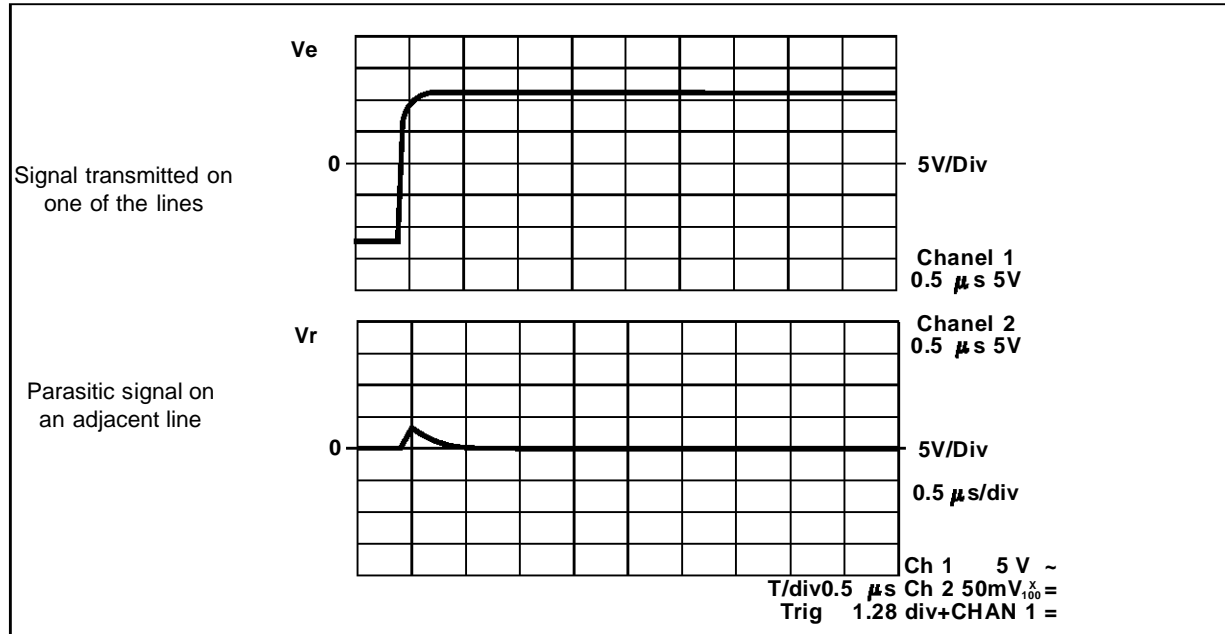

Figure 9 : Inter-Line Interface (duration)



The +/- 2.5V superimposed on the +/- 12V of the real signal are not detected by line receivers whose threshold is generally adjusted to +/- 1V. Additionally, the sampling system of the UART series interface circuits "hides" the disturbances of 0.4 us among the 51 us of one bit at 19600 bauds (see Fig. 9).

8) Use of the ITAxxx







In conclusion, the table below gives a matrix of the uses of the ITAxxx according to the type of line to be protected. The main products are listed here, but others are equally available for more specific applications. (See Annex 2, Transil Arrays-Configurations).

Transil Array Utilization

DATA LINE	2/4 LINES SO8	5/8 LINES SO20	18 LINES SO20
CENTRONICS 0/5V	ITA6V1U1	ITA6V1U3	ITA6V1M3 LCTA6V1M3 (Low Capacitance)
RS485/422 0/- 6V	ITA6V1U1	ITA6V1U3	
RS423 +/- 6V	ITA10B1	ITA10B3	
RS232 +/- 12V	ITA18B1 ITA25B1	ITA18B3 ITA25B3	

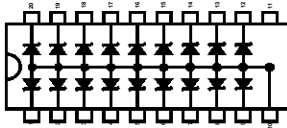
ANNEX 1

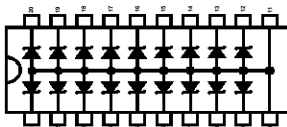
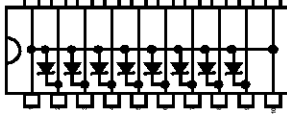
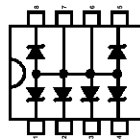
Transil Arrays Product Range-Configurations

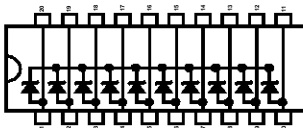
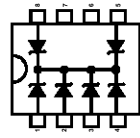
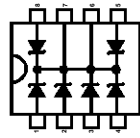
UNIDIRECTIONAL	 SO 20  SO 8	    	18 TRANSIL 8 TRANSIL 18 TRANSIL 8 TRANSIL 6 TRANSIL	<table border="1"> <tr> <td colspan="2" data-bbox="1156 291 1226 678">Low Capacitance</td> </tr> <tr> <td data-bbox="1226 291 1315 489">LCTA6V1U3</td> <td data-bbox="1226 489 1315 678">LCTA6V1M3</td> </tr> </table>	Low Capacitance		LCTA6V1U3	LCTA6V1M3
Low Capacitance								
LCTA6V1U3	LCTA6V1M3							
BIDIRECTIONAL	 SO 20  SO 8	  	8 TRANSIL 4 TRANSIL	<table border="1"> <tr> <td data-bbox="1156 1245 1226 1442"> ITA6V5B3 ITA10B3 ITA18B3 ITA25B3 </td> <td data-bbox="1156 1442 1226 1627"> ITA6V5C1 ITA10C1 ITA18C1 ITA25C1 </td> <td data-bbox="1156 1627 1226 1818"> ITA6V5B1 ITA10B1 ITA18B1 ITA25B1 </td> </tr> </table>	ITA6V5B3 ITA10B3 ITA18B3 ITA25B3	ITA6V5C1 ITA10C1 ITA18C1 ITA25C1	ITA6V5B1 ITA10B1 ITA18B1 ITA25B1	
ITA6V5B3 ITA10B3 ITA18B3 ITA25B3	ITA6V5C1 ITA10C1 ITA18C1 ITA25C1	ITA6V5B1 ITA10B1 ITA18B1 ITA25B1						

ANNEX 2

Protection Standards Applicable to
Computer and Electronic Systems

TYPE OF DISTURBANCE	PROTECTION STANDARD.			APPLICATION
	REFERENCE	LEVEL	WAVE	
E.S.D.	IEC 801-2	1 To 4	2 kV To 15 kV 5/30 nsec	I/O of data lines
	IEC 801-4	1 To 4	0.5 kV To 4 kV 5/30 nsec WAVE TRAIN	I/O of data lines
	Human body test MIL STAND. 883c-3015.7		4 kV 5/30 nsec	I/O of data lines
	E.S.D. MIL STAND. 883c-3015.2		25 kV 5/30 nsec	I/O of data lines
E.O.S.	IEC801-5	1 To 3	0.5 kV To 2 kV 1.2/50 μ sec	I/O of data lines
E.M.I.	IEC801-3	1 To 3	27 MHz To 500MHz	I/O of data lines

Information furnished is believed to be accurate and reliable. However, SGS-THOMSON Microelectronics assumes no responsibility for the consequences of use of such information nor for any infringement of patents or other rights of third parties which may result from its use. No license is granted by implication or otherwise under any patent or patent rights of SGS-THOMSON Microelectronics. Specifications mentioned in this publication are subject to change without notice. This publication supersedes and replaces all information previously supplied.

SGS-THOMSON Microelectronics products are not authorized for use as critical components in life support devices or systems without express written approval of SGS-THOMSON Microelectronics.

© 1995 SGS-THOMSON Microelectronics - Printed in Italy - All rights reserved.

SGS-THOMSON Microelectronics GROUP OF COMPANIES

Australia - Brazil - France - Germany - Hong Kong - Italy - Japan - Korea - Malaysia - Malta - Morocco -
The Netherlands - Singapore - Spain - Sweden - Switzerland - Taiwan - Thailand - United Kingdom - U.S.A.



LittleDiode supplies new, hard to find or obsolete electronic components and semiconductors all over the world.

With over two million different components listed you are sure to find the part you need.

Feel free to visit us today at our online store:

LittleDiode.com

Looking forward to providing you with the best possible service.