

AN5095K

Single chip IC with I²C bus interface for PAL/NTSC color TV system

■ Overview

The AN5095K is an IC in which PAL/NTSC color television signal processing circuits are integrated into a single chip. Also, since the I²C bus interface is built in the IC, the rationalization of set production line can be realized.

■ Features

- Built-in video IF circuit, sound IF circuit, video signal processing circuit, color signal processing circuit, sync. signal processing circuit
- Suitable for PAL/NTSC/AV-NTSC/M-NTSC systems
- 6 dB improved sound S/N (compared with the AN5195K-B/-C)
- Package: 64-SDIP, supply voltage: 5 V, 9 V

■ Applications

- Television and televideo

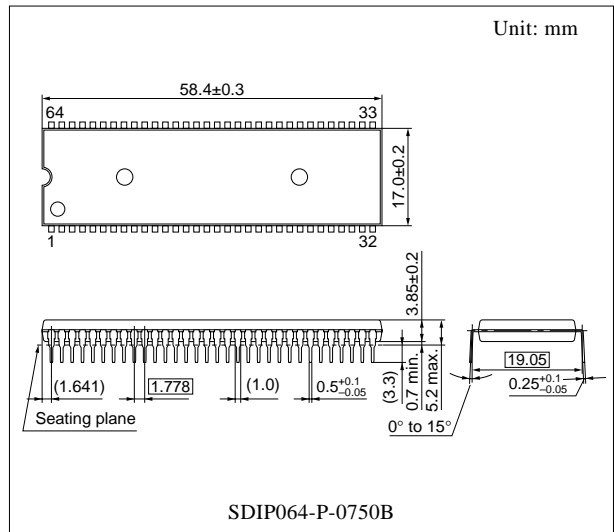

■ Pin Descriptions

| Pin No. | Description | Pin No. | Description |
|---------|---|---------|--|
| 1 | (R) clamp | 33 | SIF3 input/sharpness |
| 2 | (G) clamp | 34 | SIF regulator filter |
| 3 | (B) clamp | 35 | SIF2 input |
| 4 | Killer filter | 36 | SIF1 input |
| 5 | Killer out, 50 Hz/60 Hz out, SECAM det. out | 37 | IF AGC filter |
| 6 | Chroma APC filter | 38 | Internal video1 input |
| 7 | Chroma VCO (4.43 MHz) | 39 | SIF APC filter |
| 8 | Chroma VCO (3.58 MHz) | 40 | Internal video2 input |
| 9 | Black level det./Blank off SW | 41 | VIF detect output |
| 10 | Y _S input (fast blanking) | 42 | VIF APC 1 filter |
| 11 | External R-input | 43 | VIF VCO (f _p /2) |
| 12 | External G-input | 44 | Video output |
| 13 | External B-input | 45 | Y-input |
| 14 | V _{CC1} | 46 | H, V sync. input |
| 15 | R-output | 47 | V _{CC3-2} (chroma/jungle/DAC) |
| 16 | G-output | 48 | Chroma input/black expansion start |
| 17 | B-output | 49 | GND (video/chroma/jungle) |
| 18 | Hor.lock detect | 50 | FBP input |
| 19 | GND (R, G, B/I ² C/DAC) | 51 | V _{CC2} (hor. stability supply) |
| 20 | ACL | 52 | AFC2 filter |
| 21 | SDA | 53 | AFC1 filter |
| 22 | SCL | 54 | Hor. VCO (32 f _H) |
| 23 | V _{CC3-1} (VIF/SIF) | 55 | X-ray protection input |
| 24 | VIF1 input | 56 | Hor. pulse output |
| 25 | VIF2 input | 57 | Ver. sync. clamp |
| 26 | GND (VIF/SIF) | 58 | Ver. pulse output |
| 27 | RF AGC output | 59 | SECAM interface |
| 28 | Audio output | 60 | -(B-Y) output |
| 29 | De-emphasis | 61 | -(R-Y) output |
| 30 | AFT output | 62 | Sandcastle pulse output |
| 31 | External video input | 63 | -(B-Y) input |
| 32 | DC De-coupling filter | 64 | -(R-Y) input |

■ Absolute Maximum Ratings

| Parameter | Symbol | | Rating | Unit |
|----------------------------------|-----------|------------------|-------------|------|
| Supply voltage | V_{CC} | $V_{CC1(14)}$ | 10.5 | V |
| | | $V_{CC3(23,47)}$ | 6.0 | |
| Supply current | I_{CC} | I_{14} | 67 | mA |
| | | I_{23+47} | 126 | |
| | | I_{51} | 27 | |
| Power dissipation *2 | P_D | | 1 480 | mW |
| Operating ambient temperature *1 | T_{opr} | | -20 to +70 | °C |
| Storage temperature *1 | T_{stg} | | -55 to +150 | °C |

Note) *1: Except for the operating ambient temperature, and storage temperature, all ratings are for $T_a = 25^\circ\text{C}$.

*2: The power dissipation shown is for the IC package in free air at $T_a = 70^\circ\text{C}$.

■ Recommended Operating Range

| Parameter | Symbol | Range | Unit |
|------------------|---------------|---------------|------|
| Supply voltage | V_{CC1} | 8.1 to 9.9 | V |
| | V_{CC3} | 4.5 to 5.5 | |
| Terminal voltage | V_5 | 0 to 6 | V |
| | V_{10} | 0 to 6 | |
| | V_{11} | 0 to 6 | |
| | V_{12} | 0 to 6 | |
| | V_{13} | 0 to 6 | |
| | V_{21} | 0 to 6 | |
| | V_{22} | 0 to 6 | |
| | V_{27} | 0 to 10.5 | |
| | V_{30} | 0 to 10.5 | |
| | V_{48} | 0 to V_{14} | |
| | V_{50} | 0 to V_{47} | |
| | V_{55} | 0 to 2 | |
| V_{59} | 0 to V_{14} | | |
| Supply current | I_{51} | 10 to 25 | mA |
| Circuit current | I_{15} | -3.2 to +0.6 | mA |
| | I_{16} | -3.2 to +0.6 | |
| | I_{17} | -3.2 to +0.6 | |
| | I_{41} | -0.8 to +0.8 | |
| | I_{44} | -1.1 to +0.4 | |
| | I_{46} | -0.8 to +0.1 | |

■ Recommended Operating Range (continued)

| Parameter | Symbol | Range | Unit |
|-----------------|----------|--------------|------|
| Circuit current | I_{56} | -6.4 to +0.1 | mA |
| | I_{58} | -0.8 to +0.1 | |
| | I_{59} | -0.3 to +0.1 | |

Note) Do not apply external currents or voltages to any pins not specifically mentioned.

For circuit currents, '+' denotes current flowing into the IC, and '-' denotes current flowing out of the IC.

■ Electrical Characteristics at $T_a = 25^\circ\text{C}$

| Parameter | Symbol | Conditions | Min | Typ | Max | Unit |
|--|-------------------|---|------|------|------|---------------|
| Power Supply | | | | | | |
| Supply current 1 | I_{14} | Current at $V_{14} = 9\text{ V}$ | 39 | 48 | 57 | mA |
| Supply current 2 | I_{23} | Current at $V_{23} = 5\text{ V}$ | 7 | 10 | 13 | mA |
| Supply current 3 | I_{47} | Current at $V_{47} = 5\text{ V}$ | 49 | 63 | 77 | mA |
| Stabilized supply voltage | V_{51} | Voltage at $I_{51} = 15\text{ mA}$ | 5.8 | 6.5 | 7.2 | V |
| Stabilized supply current | I_{51} | Current at $V_{51} = 5\text{ V}$ | 2 | 5 | 7 | mA |
| Stabilized supply input resistance | R_{51} | DC measurement, slant between at $I_{51} = 10\text{ mA}$ and 25 mA | 1 | 5 | 10 | Ω |
| VIF circuit Typical input; $f_p = 38.9\text{ MHz}$, $V_{IN} = 90\text{ dB}\mu$, DAC data are typical | | | | | | |
| Video detection output (typ.) | V_{PO} | Modulation $m = 87.5\%$, data 0B = 44 | 1.7 | 2.1 | 2.5 | V[p-p] |
| Video detection output (max.) | V_{POmax} | 0B = 74 | 1.9 | 2.6 | 3.3 | V[p-p] |
| Video detection output (min.) | V_{POmin} | 0B = 04 | 1.1 | 1.6 | 2.1 | V[p-p] |
| Video detection output-frequency characteristic | f_{PC} | Frequency which becomes -3 dB for 1 MHz output | 5.5 | 8 | 12 | MHz |
| Synchronous peak value voltage | V_{SP} | Synchronized peak value voltage at V[p-0] measurement | 1.6 | 2.0 | 2.4 | V |
| APC high-level pull-in range | f_{PPH} | High-pass side pull-in range (difference from $f_p = 38.9\text{ MHz}$) | 1.0 | 2.0 | — | MHz |
| APC low-level pull-in range | f_{PPL} | Low-pass side pull-in range (difference from $f_p = 38.9\text{ MHz}$) | — | -2.0 | -1.0 | MHz |
| RF AGC delay point adjustable range *1 | ΔV_{RFDP} | Delay point in which data are 0A = 00 to 3F (input at $V_{27} = \text{approx. } 6.5\text{ V}$) | 75 | — | 95 | dB μ |
| VCO free-running frequency | Δf_p | Dispersion without V_{IN} V_{37} (IF AGC) = 0 V (measurement of the difference from 38.9 MHz) | -1.2 | 0 | 1.2 | MHz |
| RF AGC maximum sink current | I_{RFmax} | Max. current IC can sink when pin 27 is low | 1.5 | 3.0 | — | mA |
| RF AGC minimum sink current | I_{RFmin} | IC leak current at which pin 27 is high | -50 | 0 | 50 | μA |

Note) *1 to *9: Refer to "Explanation of test methods".

■ Electrical Characteristics at $T_a = 25^\circ\text{C}$ (continued)

| Parameter | Symbol | Conditions | Min | Typ | Max | Unit |
|--|--------------------------------|--|------|------|------|------------|
| VIF circuit (continued) Typical input; $f_p = 38.9\text{ MHz}$, $V_{IN} = 90\text{ dB}\mu$, DAC data are typical | | | | | | |
| AFT discrimination sensitivity *2 | μ_{AFT} | $\Delta f = \pm 25\text{ kHz}$ | 40 | 57 | 75 | mV/kHz |
| AFT center voltage | V_{AFT} | V_{30} at V_{IN} without input | 4.0 | 4.5 | 5.0 | V |
| AFT maximum output voltage | V_{AFTmax} | V_{30} at $f = f_p - 500\text{ kHz}$ | 7.8 | 8.1 | 8.7 | V |
| AFT minimum output voltage | V_{AFTmin} | V_{30} at $f = f_p + 500\text{ kHz}$ | 0.3 | 0.8 | 1.0 | V |
| Detection output resistance | R_{O41} | DC measurement, $I_O = -0.4\text{ V to }-1.0\text{ mA}$ | 70 | 120 | 170 | Ω |
| SIF circuit Typical input; $f_s = 6.0\text{ MHz}$, $f_M = 400\text{ Hz}$, $V_{IN} = 90\text{ dB}\mu$ | | | | | | |
| Audio detection output (PAL, SIF1) | V_{SOP36} | $\Delta f = \pm 50\text{ kHz}$ 0B-D3 = 0 | 0.90 | 1.15 | 1.40 | V[rms] |
| Audio detection output (PAL, SIF2) | V_{SOP35} | $\Delta f = \pm 50\text{ kHz}$ 0B-D3 = 0 | 0.90 | 1.15 | 1.40 | V[rms] |
| Audio detection output (PAL, SIF3) | V_{SOP33} | $\Delta f = \pm 50\text{ kHz}$ 0B-D3 = 0 | 0.90 | 1.15 | 1.40 | V[rms] |
| Audio detection output NTSC/PAL | $R_{\text{SN/P}}$ | $\Delta f = \pm 25\text{ kHz}$ 0B-D3 = 1, ratio to PAL (V_{SOP36}) | -2.5 | -0.5 | 1.5 | dB |
| Audio detection output linearity | ΔV_{SOP} | $f_s = 5.5\text{ MHz and }6.0\text{ MHz}$ ratio to 6.5 MHz | -3 | 0 | 3 | dB |
| SIF pull-in range NTSC (4.5 MHz) | $f_{\text{SNH}} (4.5\text{M})$ | Pull-in range of high-pass side | 4.8 | 5.0 | — | MHz |
| SIF pull-in range NTSC (4.5 MHz) | $f_{\text{SNL}} (4.5\text{M})$ | Pull-in range of low-pass side | — | 4.0 | 4.2 | MHz |
| SIF pull-in range PAL (5.5 MHz) | $f_{\text{SPH}} (5.5\text{M})$ | Pull-in range of high-pass side | 5.8 | 6.0 | — | MHz |
| SIF pull-in range PAL (5.5 MHz) | $f_{\text{SPL}} (5.5\text{M})$ | Pull-in range of low-pass side | — | 5.0 | 5.2 | MHz |
| SIF pull-in range PAL (6.0 MHz) | $f_{\text{SPH}} (6.0\text{M})$ | Pull-in range of high-pass side | 6.3 | 6.5 | — | MHz |
| SIF pull-in range PAL (6.0 MHz) | $f_{\text{SPL}} (6.0\text{M})$ | Pull-in range of low-pass side | — | 5.5 | 5.7 | MHz |
| SIF pull-in range PAL (6.5 MHz) | $f_{\text{SPH}} (6.5\text{M})$ | Pull-in range of high-pass side | 6.8 | 7.0 | — | MHz |
| SIF pull-in range PAL (6.5 MHz) | $f_{\text{SPL}} (6.5\text{M})$ | Pull-in range of low-pass side | — | 6.0 | 6.2 | MHz |
| De-emphasis terminal output resistance (PAL) | R_{29P} | Impedance of pin 29 at PAL | 32 | 40 | 48 | k Ω |
| De-emphasis terminal output resistance (NTSC) | R_{29N} | Impedance of pin 29 at NTSC | 48 | 60 | 72 | k Ω |

Note) *1 to *9: Refer to "Explanation of test methods".

■ Electrical Characteristics at $T_a = 25^\circ\text{C}$ (continued)

| Parameter | Symbol | Conditions | Min | Typ | Max | Unit |
|--|------------------|--|------|------|------|------------|
| AV SW circuit | | | | | | |
| Video SW voltage gain | G_{VSW} | $f = 1 \text{ MHz}$, $V_{IN} = 1 \text{ V[p-p]}$ | 5.7 | 6.7 | 7.7 | dB |
| Video SW-frequency characteristic | f_{VSW} | Frequency to become -3 dB from $f = 1 \text{ MHz}$, $V_{IN} = 0.714 \text{ V[0-p]}$ | 8 | 10 | — | MHz |
| Video SW external input terminal voltage | V_{31} | DC measurement | 1.7 | 2.0 | 2.3 | V |
| Video SW external output DC voltage | V_{44E} | DC measurement, 03-D7 = 1, 0B-D7 = 1 | 4.2 | 4.8 | 5.4 | V |
| Video SW external input resistance | R_{I31} | DC measurement | 44 | 56 | 68 | k Ω |
| Video SW output resistance | R_{O44} | DC measurement, $I_O = -0.6 \text{ mA}$ to -1.0 mA | 110 | 150 | 190 | Ω |
| Video SW internal clamp terminal voltage | $V_{38,40}$ | DC measurement, $I_{IN} = -1.0 \text{ mA}$ | 1.4 | 1.7 | 2.0 | V |
| Video SW internal output DC voltage | V_{44I} | DC measurement | 3.7 | 4.3 | 4.9 | V |
| Audio SW voltage gain | G_{ASW} | Data 03-D7 = 1, 0B-D7 = 1, (input from outside) $f = 400 \text{ Hz}$, $V_{IN} = 1 \text{ V[p-p]}$ | -1 | 0 | 1 | dB |
| Audio SW output DC voltage | V_{28} | DC measurement | 3.7 | 4.2 | 4.7 | V |
| Audio SW output resistance | R_{O28} | DC measurement | 350 | 450 | 550 | Ω |
| Video signal processing circuit Typical input; 0.6 V[p-p] ($V_{BW} = 0.42 \text{ V[p-p]}$ stair-step) at G-out | | | | | | |
| Video output (typ.) | V_{YO} | Data 03 = 20 (typ.) (contrast) | 2.0 | 2.5 | 3.0 | V[0-p] |
| Video output (max.) | V_{YOmax} | Data 03 = 3F (max.) | 4.1 | 5.0 | 5.9 | V[0-p] |
| Video output (min.) | V_{YOmin} | Data 03 = 00 (min.) | 0.15 | 0.50 | 1.00 | V[0-p] |
| Contrast variable range | $Y_{Cmax/min}$ | $\frac{03 = 3F}{03 = 00}$ | 15 | 20 | 25 | dB |
| Video frequency characteristic | f_{YC} | Pin 33 = 5 V (sharpness), frequency to become -3 dB from $f = 0.2 \text{ MHz}$ | 5.5 | 6.0 | — | MHz |
| Picture quality variable range | $Y_{Smax/min}$ | $\frac{V_{33} = 7V}{V_{33} = 5V}$ $f = 3.8 \text{ MHz}$ | 9 | 13 | 17 | dB |
| Pedestal level (typ.) | V_{PED} | Data 02 = 40 (typ.) (brightness) | 2.0 | 2.5 | 3.0 | V |
| Pedestal variable width | ΔV_{PED} | Difference between data 02 = 00 and 7F | 2.15 | 2.75 | 3.35 | V |
| Brightness control sensitivity | ΔV_{BRT} | Average amount of change per 1-step between data 02 = 30 and 50 | 14 | 20 | 26 | mV/Step |
| Video input clamp voltage | V_{YCLP} | Pin 45 clamp voltage | 3.2 | 3.7 | 4.2 | V |
| ACL sensitivity | ACL | Amount of change of Y-out, when $V_{20} = 3.0 \text{ V} \rightarrow 3.5 \text{ V}$ | 2.7 | 3.2 | 3.7 | V/V |
| Blanking level | V_{YBL} | Blanking pulse DC voltage | — | 1.0 | 1.5 | V |

■ Electrical Characteristics at T_a = 25°C (continued)

| Parameter | Symbol | Conditions | Min | Typ | Max | Unit |
|---|-----------------------|--|------|------|------|---------------|
| Video signal processing circuit (continued) Typical input; 0.6 V[p-p] (V _{BW} = 0.42 V[p-p] stair-step) at G-out | | | | | | |
| Service SW * threshold voltage | V _{STH} | Voltage at which vertical output stops when pin 20 (ACL) voltage is decreased | — | — | 0.3 | V |
| DC restoration ratio | T _{DC} | APL10% to 90% $T_{DC} = \frac{\Delta AC - \Delta DC}{\Delta AC} \times 100$ | 90 | 100 | 110 | % |
| Video input clamp current | I _{YCLP} | DC measurement; Sink current inside of IC | 6 | 11 | 16 | μA |
| Pedestal difference voltage | ΔV _{IPL} | Pedestal difference voltage of R, G, B-out | -0.2 | 0 | 0.2 | V |
| Brightness voltage tracking | ΔT _{BL} | Ratio of R, G, B-out fluctuation level for data 02 (bright) = 20 to 60 | 0.9 | 1.0 | 1.1 | Time |
| Video voltage gain relative ratio | ΔG _{YC} | Output ratio of R, B-out against G-out | 0.8 | 1.0 | 1.2 | Time |
| Video voltage gain tracking | ΔT _{CONT} | Ratio of gain of R, G, B-out for data 03 (contrast) = 10 to 30 | 0.9 | 1.0 | 1.1 | Time/ Time |
| Color signal processing circuit Burst 150 mV[p-p] (PAL), reference is B-out | | | | | | |
| Color-difference output (typ.) | V _{CO} | Input; Color bar Data 00 = 20 (typ.), 03 = 20 (typ.) | 2.9 | 3.7 | 4.5 | V[p-p] |
| Color-difference output (max.) | V _{COmax} | Data 03 = 3F, amplitude of one side 03 = 20 | 2.6 | 3.3 | — | V[0-p] |
| Color-difference output (min.) | V _{COmin} | Data 00 = 00, 03 = 20 | — | — | 100 | mV[p-p] |
| Contrast adjustable range | C _{Cmax/min} | 03 = 3F 00 = 20 03 = 00 | 15 | 20 | 25 | dB |
| ACC characteristic 1 | ACC1 | Burst 150 mV[p-p] → 300 mV[p-p] | 0.9 | 1.0 | 1.2 | Time |
| ACC characteristic 2 | ACC2 | Burst 150 mV[p-p] → 30 mV[p-p] | 0.8 | 1.0 | 1.2 | Time |
| NTSC tint center | Δθ _C | The difference from data 01 = 20 at which tint is adjusted to center | -7 | 0 | 7 | Step |
| NTSC tint adjustable range 1 | Δθ ₁ | Input; Rainbow data 01 = 3F | 30 | 50 | 65 | deg |
| NTSC tint adjustable range 2 | Δθ ₂ | Input; Rainbow data 01 = 00 | -65 | -50 | -30 | deg |
| Color-difference output ratio (R) | R/B | Input; Rainbow for both PAL/NTSC | 0.46 | 0.56 | 0.66 | Time |
| Color-difference output ratio (G) | G/B | Input; Rainbow for both PAL/NTSC | 0.28 | 0.34 | 0.40 | Time |
| Color-difference output angle (R) | ∠R | Input; Rainbow for both PAL/NTSC | 78 | 90 | 102 | deg |
| Color-difference output angle (G) | ∠G | Input; Rainbow for both PAL/NTSC | 224 | 236 | 248 | deg |
| PAL color killer tolerance | V _{KILLP} | 0 dB = 150 mV[p-p] | -57 | -44 | -34 | dB |
| NTSC color killer tolerance | V _{KILLN} | 0 dB = 150 mV[p-p] | -57 | -44 | -34 | dB |
| APC high-level pull-in range | f _{CPH} | Both PAL/NTSC | 450 | 700 | — | Hz |
| APC low-level pull-in range | f _{CPL} | Both PAL/NTSC | — | -700 | -450 | Hz |
| Color killer detection output voltage (color) | V _{KC} | V ₅ , killer out at which chroma input data 0A-D6 = 0, 0A-D7 = 1 | 4.5 | 5.0 | — | V |

Note) *: Since pin 20 is also used partly as service SW when used as ACL, a sufficient care must be taken so as not to become V₂₀ < 0.9 V in carrying out set design.

■ Electrical Characteristics at $T_a = 25^\circ\text{C}$ (continued)

| Parameter | Symbol | Conditions | Min | Typ | Max | Unit |
|---|-----------------------|--|------|------|------|---------------|
| Color signal processing circuit (continued) Burst 150 mV[p-p] (PAL), reference is B-out | | | | | | |
| Color killer detection output voltage (B & W) | V_{KBW} | V_5 , killer out at which chroma input data 0A-D6 = 0, 0A-D7 = 1 | 0 | 0.1 | 0.5 | V |
| Demodulation output -(B-Y) | V_{DB} | Input; Color bar measured at pin 60 for both PAL/NTSC | 555 | 695 | 835 | mV[p-p] |
| Demodulation output -(R-Y) | V_{DR} | Input; Color bar measured at pin 61 for both PAL/NTSC | 430 | 540 | 650 | mV[p-p] |
| Demodulation output angle \angle (B-Y) | $\angle R_{DB}$ | B-Y axis out of phase | -6 | 0 | 6 | deg |
| Demodulation output angle \angle (R-Y) | $\angle R_{DR}$ | B-Y axis phase difference | 84 | 90 | 96 | deg |
| CW output level (4.43 MHz) *3 | V_{CWP} | AC component, when VCO is set at 4.43 MHz | 250 | 350 | 450 | mV[p-p] |
| CW output level (3.58 MHz) *3 | V_{CWN} | AC component, when VCO is set at 3.58 MHz | — | — | 50 | mV[p-p] |
| CW output level period (SECAM) *3 | t_{CW} | Period in which CW is outputted at SECAM, PAL | 1.31 | 1.41 | 1.51 | ms |
| SECAM judgment current | I_{SECAM} | The minimum value to take out current from pin 59 to discriminate as SECAM | 50 | 100 | 150 | μA |
| SECAM judgment output | V_{SE} | V_5 , det. out, when SECAM signal input data 0A-D6 = 1, 0A-D7 = 0, SECAM | 4.5 | 5.0 | — | V |
| PAL/NTSC DC level | V_{59PN} | V_{59} DC level at PAL/NTSC | 0.8 | 1.3 | 1.65 | V |
| SECAM DC level | V_{59S} | V_{59} DC level at SECAM | 4.1 | 4.6 | 5.1 | V |
| RGB processing circuit DAC data are typical | | | | | | |
| Drive adjusting range | G_{DV} | AC change amount for R, B-out between drive adjustment max. and min. | 5 | 6 | 7 | dB |
| Offset adjusting range | $V_{CUT-OFF}$ | DC change amount for R, G, B-out between offset adjustment max. and min. | 2.2 | 2.5 | 2.8 | V |
| Y_S threshold voltage | V_{YSON} | Minimum DC voltage at which Y_S turns on | 1.0 | — | — | V |
| Y_S threshold voltage | V_{YSOF} | Maximum DC voltage at which Y_S turns off | — | — | 0.4 | V |
| External R, G, B pedestal difference voltage | ΔV_{EPL} | $Y_S = 1\text{ V}$ is applied | -200 | 0 | 200 | mV |
| Internal and external pedestal difference voltage | $\Delta V_{PL/IE}$ | Internal part — external part | -200 | 0 | 200 | mV |
| External R, G, B output voltage | V_{ERGB} | Input 0.7 V[p-p], contrast 03 = 20 (typ.) | 1.8 | 2.2 | 2.7 | V[p-p] |
| External R, G, B output difference voltage | ΔV_{ERGB} | Input 0.7 V[p-p], contrast 03 = 20 (typ.) | 0.8 | 1.0 | 1.2 | Time |
| External R, G, B contrast variable range | $EC_{\text{max/min}}$ | $\frac{03 = 3F}{03 = 00}$ | 12 | 17 | 22 | dB |

Note) *1 to *9: Refer to "Explanation of test methods".

■ Electrical Characteristics at $T_a = 25^\circ\text{C}$ (continued)

| Parameter | Symbol | Conditions | Min | Typ | Max | Unit |
|--|------------------------|--|-----------|-----------|-------|---------------|
| RGB processing circuit (continued) DAC data are typicals | | | | | | |
| External R, G, B frequency characteristic | f_{RGBC} | Input 0.2 V[p-p] | 8 | 10 | — | MHz |
| Internal and external R, G, B output voltage ratio | $V_{\text{E/I}}$ | External part 0.7 V[p-p]/internal part 0.6 V[p-p] input, contrast 03 = 20 (typ.) | 0.78 | 0.92 | 1.06 | Time |
| Synchronizing signal processing circuit | | | | | | |
| Horizontal free run frequency | f_{HO} | Without sync. signal input | 15.33 | 15.63 | 15.93 | kHz |
| Horizontal output pulse duty cycle | τ_{HO} | Upward pulse duty cycle | 31 | 37 | 43 | % |
| Horizontal pull-in range | f_{HP} | Difference from $f_{\text{H}} = 15.625$ kHz | ± 500 | ± 650 | — | Hz |
| PAL horizontal free run frequency | $f_{\text{VO-P}}$ | Data 01-D7 = 1, 02-D7 = 0, forced 50 Hz mode, without sync. signal input | 48 | 50 | 52 | Hz |
| NTSC vertical free run frequency | $f_{\text{VO-N}}$ | Data 01-D7 = 1, 02-D7 = 1, forced 60 Hz mode, without sync. signal input | 58 | 60 | 62 | Hz |
| Vertical output pulse width | τ_{VO} | For both PAL/NTSC | 9 | 10 | 11 | 1/fH |
| PAL vertical pull-in range | f_{VPP} | $f_{\text{H}} = 15.625$ kHz, forced 50 Hz mode | 46 | — | 54 | Hz |
| NTSC vertical pull-in range | f_{VPN} | $f_{\text{H}} = 15.75$ kHz, forced 60 Hz mode | 56 | — | 64 | Hz |
| Horizontal high-level output voltage | $V_{56\text{H}}$ | High-level DC voltage | 2.8 | 3.1 | 3.4 | V |
| Horizontal low-level output voltage | $V_{56\text{L}}$ | Low-level DC voltage | — | — | 0.3 | V |
| Vertical high-level output voltage | $V_{58\text{H}}$ | High-level DC voltage | 3.9 | 4.2 | 4.5 | V |
| Vertical low-level output voltage | $V_{58\text{L}}$ | Low-level DC voltage | — | — | 0.3 | V |
| Screen center variable range | ΔT_{HC} | Change amount of phase difference between sync. and H-out of data 0B = 40 to 47 | 2.6 | 3.2 | 4.4 | μs |
| Overvoltage protection operation voltage | $V_{\text{X-RAY}}$ | The pin 55 minimum voltage at which H-out does not appear any longer | 0.60 | 0.68 | 0.76 | V |
| Vertical frequency discrimination (50) | f_{50} | Vertical frequency at which V_5 becomes low (< 0.5 V) | 47 | — | 55 | Hz |
| Vertical frequency discrimination (60) | f_{60} | Vertical frequency at which V_5 becomes high (> 4.5 V) | 57 | — | 63 | Hz |
| Synchronous signal clamp voltage | V_{46} | V_{46} clamp voltage | 1.1 | 1.4 | 1.7 | V |
| Horizontal output start voltage | V_{IHS} | The minimum V_{50} at $f_0 > 10$ kHz and horizontal oscillation output is higher than 1 V[p-p] | 3.4 | 4.2 | 5.0 | V |
| I ² C interface | | | | | | |
| Sink current when ACK | I_{ACK} | The maximum value of pin 21 sink current at ACK | 1.5 | 2.0 | 5.0 | mA |
| SCL, SDA signal high level input | V_{IHI} | | 3.1 | — | — | V |
| SCL, SDA signal low level input | V_{ILO} | | — | — | 0.9 | V |
| Allowable maximum input frequency | f_{Imax} | | — | — | 100 | kbit/s |

■ Electrical Characteristics at $T_a = 25^\circ\text{C}$ (continued)

• Design reference data

Note) The characteristics listed below are theoretical values based on the IC design and are not guaranteed.

| Parameter | Symbol | Conditions | Min | Typ | Max | Unit |
|---|--------------------|---|-----|-------|----------|------------------|
| VIF circuit Typical input; $f_p = 38.9\text{ MHz}$, $V_{IN} = 90\text{ dB}\mu$ | | | | | | |
| Input sensitivity | V_{PS} | Input level at which V_{PO1} becomes -3 dB | — | 45 | — | $\text{dB}\mu$ |
| Maximum allowable input | V_{Pmax} | Input level at which V_{PO1} becomes $+1\text{ dB}$ | — | 110 | — | $\text{dB}\mu$ |
| SN ratio | SN_P | | 50 | — | — | dB |
| Differential gain | DG_P | | — | — | 5 | % |
| Differential phase | DP_P | | — | — | 5 | deg |
| Black-noise detection level *4 | ΔV_{BN} | Difference from sync. peak value | — | -45 | — | IRE |
| Black-noise clamp level *4 | ΔV_{BNC} | Difference from sync. peak value | — | 45 | — | IRE |
| RF-AGC operation sensitivity | G_{RF} | Input level difference, when $V_{27} = 1\text{ V}$ goes to 7 V | 0.5 | — | 3.0 | dB |
| VCO switch-on drift | Δf_{PD} | Frequency drift from 5 sec. to 5 min. after SW-on | — | — | 200 | kHz |
| Inter modulation *5 | IM | $V_{fC} - V_{fP} = -2\text{ dB}$, $V_{fS} - V_{fP} = -12\text{ dB}$ | 46 | — | — | dB |
| RF-AGC adjustment sensitivity | S_{RF} | Output voltage in data 1-step, average change amount of V_{27} | 1 | — | 4 | V/step |
| AFT offset adjustment sensitivity | S_{AFT} | Output voltage in data 1-step, average change amount of V_{30} | 0.1 | — | 0.3 | V/step |
| Video detection output fluctuation with V_{CC} | $\Delta V_{P/V}$ | $V_{CC} = \pm 10\%$ | — | — | ± 15 | % |
| Video detection output-temperature characteristics | $\Delta V_{P/T}$ | $T_a = -20^\circ\text{C}$ to $+70^\circ\text{C}$ | — | — | ± 10 | % |
| Input resistance (pin 24, pin 25) | $R_{I24,25}$ | $f = 38.9\text{ MHz}$ | — | 1.2 | — | $\text{k}\Omega$ |
| Input capacitance (pin 24, pin 25) | $C_{I24,25}$ | $f = 38.9\text{ MHz}$ | — | 4.0 | — | pF |
| Sound-IF output level | V_{SIF} | $f_S = 38.9\text{ MHz} - 6.0\text{ MHz}$, $P/S = 20\text{ dB}$ | 90 | — | 110 | $\text{dB}\mu$ |
| VCO control sensitivity | β_P | $\Delta V_{42} = \pm 0.1\text{ V}$ | 2.0 | — | 3.5 | kHz/mV |
| VCO adjustment range | f_{VCO} | Free-running frequency change width at data 0C = 00 to 7F | 3 | — | 5 | MHz |
| RF-AGC delay point-temperature characteristics | $\Delta V_{DP/T}$ | $T_a = -20^\circ\text{C}$ to $+70^\circ\text{C}$ | — | — | 5 | dB |
| VCO free-running frequency-temperature characteristics | $\Delta f_{P/T}$ | $T_a = -20^\circ\text{C}$ to $+70^\circ\text{C}$ | — | 300 | — | kHz |
| AFT center frequency-temperature characteristics | $\Delta f_{AFT/T}$ | Input frequency at which AFT output voltage becomes 4.5 V , $T_a = -20^\circ\text{C}$ to $+70^\circ\text{C}$ | — | 300 | — | kHz |
| External mode output DC voltage | V_{41EXT} | Output DC voltage at AV-SW outside mode | 0.5 | 1.0 | 1.8 | V |

Note) *1 to *9: Refer to "Explanation of test methods".

■ Electrical Characteristics at $T_a = 25^\circ\text{C}$ (continued)

• Design reference data (continued)

Note) The characteristics listed below are theoretical values based on the IC design and are not guaranteed.

| Parameter | Symbol | Conditions | Min | Typ | Max | Unit |
|---|------------------|---|--------|------|----------|------------------|
| SIF circuit Typical input; $f_S = 6.0\text{ MHz}$, $f_M = 400\text{ Hz}$, $V_{IN} = 90\text{ dB}\mu$ | | | | | | |
| Input limiting level | V_{LIM} | Input level, when V_{SOP} becomes -3 dB | — | — | 50 | $\text{dB}\mu$ |
| AM rejection ratio | AMR | AM = 30% | 55 | — | — | dB |
| Total harmonic distortion | THD | $\Delta f = \pm 50\text{ kHz}$ | — | — | 1.0 | % |
| SN ratio | SN_A | $\Delta f = \pm 50\text{ kHz}$, $f_M = 400\text{ Hz}$, on/off | 55 | — | — | dB |
| Audio output fluctuation with V_{CC} | $\Delta V_{S/V}$ | $V_{CC} = \pm 10\%$ | — | — | ± 10 | % |
| Audio output - temperature characteristics | $\Delta V_{S/T}$ | $T_a = -20^\circ\text{C}$ to $+70^\circ\text{C}$ | — | — | ± 10 | % |
| SIF input resistance | R_{I35} | DC measurement | — | 31.5 | — | $\text{k}\Omega$ |
| SIF input resistance | R_{I36} | DC measurement | — | 31.5 | — | $\text{k}\Omega$ |
| AV-SW circuit | | | | | | |
| Video-SW crosstalk (inside \rightarrow inside) | C_{TVII} | $f = 1\text{ MHz}$, $V_{IN} = 1\text{ V[p-p]}$, inside \rightarrow inside | — | — | -55 | dB |
| Video-SW crosstalk (outside \rightarrow inside) | C_{TVEI} | $f = 1\text{ MHz}$, $V_{IN} = 1\text{ V[p-p]}$, inside \rightarrow outside, outside \rightarrow inside | — | — | -55 | dB |
| Audio-SW crosstalk (inside \rightarrow inside) | C_{TAII} | $f_S = 6.5\text{ MHz}$, $f_M = 400\text{ Hz}$, $V_{IN} = 1\text{ V[p-p]}$, $f_S = 6.5\text{ MHz}$, $f_M = 1.0\text{ kHz}$, $V_{IN} = 1\text{ V[p-p]}$ | — | — | -60 | dB |
| Video signal processing circuit Typical input; 0.6 V[p-p] ($V_{BW} = 0.42\text{ V[p-p]}$ stair-step) at G-out | | | | | | |
| Black level expansion 1 *6 | V_{BL1} | Input: All black, difference between pin 9 = 9 V and open (with RC) | -100 | 0 | 100 | mV |
| Black level expansion 2 *6 | V_{BL2} | Input: All black, difference between pin 9 = 3 V and 9 V | 400 | 700 | 1000 | mV |
| Black level expansion 3 *6 | V_{BL3} | Input: Approx. 20 IRE, voltage difference between pin 9 = open and 9 V at 03 (contrast) = 3F (max.) | 100 | 300 | 500 | mV |
| Contrast change by sharpness | ΔV_{CS} | Y-out output difference at sharpness between max. and min. | -300 | 0 | 300 | mV |
| Brightness change by sharpness | ΔV_{BS} | Pedestal level DC difference at sharpness between max. and min. | -250 | 0 | 250 | mV |
| Input dynamic change | V_{Imax} | 03 (contrast) = 20 (typ.) | — | — | 1.6 | V[p-p] |
| Y-signal SN-ratio | SN_Y | 03 (contrast) = 3F (max.) | 53 | — | — | dB |
| Black level expansion start point *6 | V_{BLS} | Start point at $V_{48} = 4.5\text{ V}$ | 37 | 42 | 47 | IRE |
| Video output fluctuation with V_{CC} | $\Delta V_{Y/V}$ | $V_{CC1} = 9\text{ V}$ (allowance: $\pm 10\%$) | — | — | ± 15 | % |
| Video output - temperature characteristics | $\Delta V_{Y/T}$ | $T_a = -20^\circ\text{C}$ to $+70^\circ\text{C}$ | — | — | ± 10 | % |
| ACL start point | V_{ACL} | V_{20} at which the output amplitude becomes 90% when ACL terminal (V_{20}) is decreased from 5 V | 3.4 | 3.7 | 4.0 | V |

Note) *1 to *9: Refer to "Explanation of test methods".

■ Electrical Characteristics at $T_a = 25^\circ\text{C}$ (continued)

• Design reference data (continued)

Note) The characteristics listed below are theoretical values based on the IC design and are not guaranteed.

| Parameter | Symbol | Conditions | Min | Typ | Max | Unit |
|---|---------------------|---|-----------|-----------|-----------|-------------------|
| Color signal processing circuit Burst 150 mV[p-p] (PAL), reference is B-out | | | | | | |
| Demodulation output residual carrier | V_{CAR1} | $2f_{SC}$ level of pin 60 and pin 61 | — | — | 30 | mV |
| Color-difference output residual carrier | V_{CAR2} | $2f_{SC}$ level of pin 15, pin 16 and pin 17 | — | — | 50 | mV |
| VCO free-running frequency (PAL) | f_{CP} | Difference from $f = 4.433619$ MHz | -300 | — | 300 | Hz |
| VCO free-running frequency (NTSC) | f_{CN} | Difference from $f = 3.579545$ MHz | -300 | — | 300 | Hz |
| f_{CO} fluctuation with V_{CC} | $\Delta f_C/V_{CC}$ | $V_{CC1} = 9$ V (allowance: $\pm 10\%$), $V_{CC3} = 5$ V (allowance: $\pm 10\%$) | -300 | — | 300 | Hz |
| Static phase error (PAL) | $\Delta\theta_P$ | Tint gap at $\Delta f_C = -300$ Hz to $+300$ Hz change | — | — | 5 | deg/ 100 Hz |
| Static phase error (NTSC) | $\Delta\theta_N$ | Tint gap at $\Delta f_C = -300$ Hz to $+300$ Hz change | — | — | 5 | deg/ 100 Hz |
| PAL/NTSC ratio | $R_{P/N}$ | Output amplitude ratio between PAL and NTSC | 0.7 | 1.0 | 1.3 | Time |
| Line crawling | ΔV_{PAL} | Pin 61: Output amplitude difference per 1H at -(R-Y) terminal | — | — | 50 | mV |
| Color-difference output bandwidth | f_{CC} | Band to become -3 dB | 1.0 | — | — | MHz |
| Color-difference output fluctuation with V_{CC} | ΔV_{CV} | $V_{CC1} = 9$ V (allowance: $\pm 10\%$), $V_{CC3} = 5$ V (allowance: $\pm 10\%$) | — | — | ± 15 | % |
| Color-difference output - temperature characteristics | ΔV_{CT} | $T_a = -20^\circ\text{C}$ to 70°C | — | — | ± 15 | % |
| PAL/NTSC output impedance | $R_{O60,61PN}$ | DC measurement | 400 | 510 | 620 | Ω |
| SECAM output impedance | $R_{O60,61S}$ | DC measurement | 100 | — | — | k Ω |
| Color, black & white DC difference voltage | ΔV_{CBW} | Pedestal voltage difference between with and without burst signal | -60 | 0 | 60 | mV |
| (C-Y)/Y ratio *7 | $R_{C/Y}$ | Color bar input, B-out contrast typ. color data 00 = 30 | 0.9 | 1.2 | 1.5 | V[0-p]/ V[0-p] |
| RGB processing circuit | | | | | | |
| Y_S change-over speed | f_{YS} | f_{YS} , when Y_S input is 3 V[0-p] and output level is -3 dB | 7 | — | — | MHz |
| Outside R, G, B input dynamic range | V_{DEXT} | Contrast max. data 03 = 3F | 1.0 | — | — | V[p-p] |
| Inside and outside crosstalk | CT_{RGB} | Leakage at $f = 1$ MHz, 1 V[p-p], $Y_S = 5$ V | — | — | -50 | dB |
| Synchronizing signal processing circuit | | | | | | |
| Lock detection output voltage | V_{LD} | V_{18} at horizontal AFC lock | 5.7 | 6.3 | 6.9 | V |
| Lock detection charge and discharge current | I_{LD} | DC measurement | ± 0.6 | ± 0.8 | ± 1.1 | mA |

Note) *1 to *9: Refer to "Explanation of test methods".

■ Electrical Characteristics at $T_a = 25^\circ\text{C}$ (continued)

• Design reference data (continued)

Note) The characteristics listed below are theoretical values based on the IC design and are not guaranteed.

| Parameter | Symbol | Conditions | Min | Typ | Max | Unit |
|---|----------------------|---|------|------|------|---------------------------|
| Synchronizing signal processing circuit (continued) | | | | | | |
| FBR (R, G, B) slice level | V_{FBP} | Pin 50 minimum voltage at which blanking is applied to R, G, B output | 0.4 | 0.75 | 1.1 | V |
| FBP (AFC2) slice level | V_{FBPH} | Pin 50 minimum voltage in which AFC2 operates | 1.5 | 1.9 | 2.3 | V |
| Horizontal AFC μ | μ_{H} | DC measurement | 30 | 37 | 44 | $\mu\text{A}/\mu\text{s}$ |
| Horizontal VCO β | β_{H} | β curve slant near $f = 15.75$ kHz | 1.4 | 1.9 | 2.4 | Hz/mV |
| Burst gate pulse position *8 | P_{BGP} | Delay from H sync. rise for both PAL/NTSC | 0.2 | 0.4 | 0.6 | μs |
| PAL burst gate pulse width *8 | W_{BGPP} | | 3.4 | 4.0 | 4.6 | μs |
| NTSC burst gate pulse width *8 | W_{BGPN} | | 2.5 | 3.0 | 3.5 | μs |
| Burst gate pulse output voltage | V_{BGP} | Pin 62 DC voltage during BGP period | 4.5 | 4.7 | 4.9 | V |
| H blanking pulse output voltage | V_{HBLK} | Pin62 DC voltage during H blanking pulse period | 2.1 | 2.4 | 2.7 | V |
| V blanking pulse output voltage | V_{VBLK} | Pin62 DC voltage during V blanking pulse period | 2.1 | 2.4 | 2.7 | V |
| PAL V blanking pulse width | W_{VP} | Pulse width at $f = 15.625$ kHz | 1.31 | 1.41 | 1.51 | ms |
| NTSC V blanking pulse width | W_{VN} | Pulse width at $f = 15.73$ kHz | 1.01 | 1.11 | 1.21 | ms |
| FBP allowable range *9 | T_{FBP} | Time from H-out rise to FBP center | 12 | — | 19 | μs |
| FBP maximum allowable input voltage | V_{AFBP} | | 2.5 | — | 5.0 | V |
| I ² C interface | | | | | | |
| Bus free before start | t_{BUF} | | 4.0 | — | — | μs |
| Start condition set-up time | $t_{\text{SU, STA}}$ | | 4.0 | — | — | μs |
| Start condition hold time | $t_{\text{HD, STA}}$ | | 4.0 | — | — | μs |
| Low period SCL, SDA | t_{LOW} | | 4.0 | — | — | μs |
| High period SCL | t_{HIGH} | | 4.0 | — | — | μs |
| Rise time SCL, SDA | t_{r} | | — | — | 1.0 | μs |
| Fall time SCL, SDA | t_{f} | | — | — | 0.35 | μs |
| Data set-up time (write) | $t_{\text{SU, DAT}}$ | | 0.25 | — | — | μs |
| Data hold time (write) | $t_{\text{HD, DAT}}$ | | 0 | — | — | μs |
| Acknowledge set-up time | $t_{\text{SU, ACK}}$ | | — | — | 3.5 | μs |
| Acknowledge hold time | $t_{\text{HD, ACK}}$ | | 0 | — | — | μs |
| Stop condition set-up time | $t_{\text{SU, STO}}$ | | 4.0 | — | — | μs |

Note) *1 to *9: Refer to "Explanation of test methods".

■ Electrical Characteristics at $T_a = 25^\circ\text{C}$ (continued)

• Design reference data (continued)

Note) The characteristics listed below are theoretical values based on the IC design and are not guaranteed.

| Parameter | Symbol | Conditions | Min | Typ | Max | Unit |
|------------------------------|---------------------|---|-----|-----|-----|----------|
| DAC | | | | | | |
| 3-bit, 6-bit, 7-bit DAC DNLE | $L_{3,6,7}$ | $1\text{LSB} = \{\text{data (max.)} - \text{data (00)}\} / 7, 63, 127$ | 0.1 | 1.0 | 1.9 | LSB/Step |
| 8-bit DAC DNLE | L_8 | $1\text{LSB} = \{\text{data (FF)} - \text{data (00)}\} / 255$ (7F → 80 excluded) | 0.1 | 1.0 | 1.9 | LSB/Step |
| 8-bit DAC DNLE (80) | L_{8-80} | $1\text{LSB} = \{\text{data (FF)} - \text{data (00)}\} / 255$ (7F → 80) | 0.1 | 1.0 | 2.9 | LSB/Step |
| AFT DAC overlap | ΔStep | 8-bit of AFT double-stage changeover overlap | 27 | 32 | 37 | Step |

• Explanation of test methods

*1: RF AGC delay point adjusting range: ΔV_{RFdp}

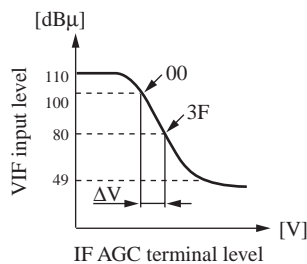

Figure 1. Gain reduction curve

In the case of VIF gain reduction curve (figure 1), if the RF AGC delay point adjustment DAC (0 A) goes 00 to 3F, the internal comparison voltage changes by ΔV , and the delay point adjustment range is determined.

*2: AFT discrimination sensitivity: μAFT

Adjust DAC (0C-D7) and DAC (09) so that the AFT output voltage (V_{30}) becomes approx. 4.5 V when $f_p = 38.9$ MHz.

Measure ΔV_{30} when $f_p = 38.9$ MHz ± 25 kHz.

*3: Refer to "■ Technical Information 4. 7) PAL/NTSC, SECAM interface".

*4: Black noise detection level: ΔV_{BN}

Black noise clamp level: ΔV_{BNC}

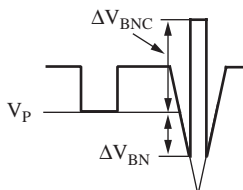

Figure 2. Black noise rejection characteristic

*5: Inter modulation: IM

Apply the signal of $f_p = 38.9$ MHz, 90 dB μ and fix the voltage of pin 37 (IF AGC) under that condition.

$f_p = 38.9$ MHz, 82 dB μ
 $f_p = 38.9$ MHz – 4.43 MHz, 80 dB μ
 $f_p = 38.9$ MHz – 6.0 MHz, 70 dB μ

} Input those 3 signals and measure 1.57 MHz component of the detection output.

$$\text{IM} = 20\text{Log} \frac{\text{vico component [rms]}}{V_{1.57 \text{ MHz}} [\text{rms}]}$$

■ Electrical Characteristics at $T_a = 25^\circ\text{C}$ (continued)

• Explanation of test methods (continued)

*6: Black level extension: V_{BL}

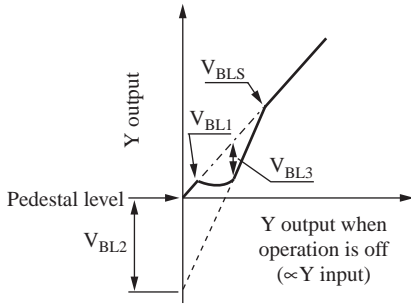

Figure 3. Black level expansion characteristics

In the black level extension characteristics (figure 3), when the voltage of pin 9 (black level detection filter) is $V_{CC1} = 9\text{ V}$, the operation of the black level extension circuit is turned off and the characteristic becomes as shown by the line - - - - -. Also, if the voltage of pin 9 is set at 3 V, the black level extension forcibly comes to start and the characteristic becomes as shown by the line - - - - -. When pin 9 is set by only R, C filter, the black level extension characteristic as shown by the line ——— can be obtained.

V_{BL3} shows an output level difference between the black extension is off and the normal operation when the video input level is constant in 20 IRE.

V_{BLS} is a point where the black extension comes to start and can be adjusted by the DC voltage of pin 48 (C_{IN}).

| V_{48} | 2.5 V | 4.5 V | 6.5 V |
|-------------|--------|--------|--------|
| Start point | 52 IRE | 42 IRE | 32 IRE |

*7: (C-Y)/Y ratio: RC/Y

C-Y is the voltage from 0 level to the peak of B-out when color is typ. (00 = 20) and contrast is typ. (03 = 20). Y is the voltage from the pedestal of contrast at typ. to 100 IRE white level.

*8: Burst gate pulse

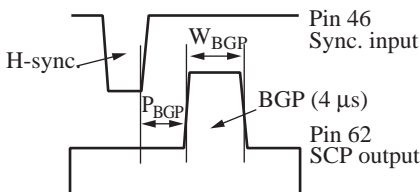

Figure 4. Burst gate pulse

As shown in figure 4, the position of the burst gate pulse is the period from the rise time of the H-sync. signal of pin 46 to the rise time of BGP.

*9: FBP allowable range : t_{FBP}

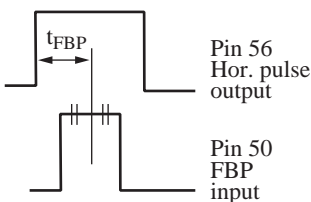
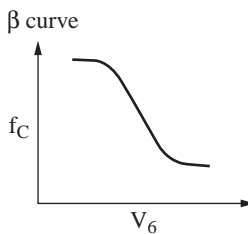

Figure 5. FBP allowable range

Figure 5 shows the relationship between Hor. pulse and FBP. The phase delay from Hor. pulse to FBP differs from set to set. This IC has an adjusting function for the screen center position. The phase range in which this function normally operate is t_{FBP} .

■ Terminal Equivalent Circuits

| Pin No. | Equivalent circuit | Description | voltage |
|-------------|--------------------|---|--|
| 1 2 3 | | <p>Pin 1; Primary color signal clamp pin (R) Pin 2; Primary color signal clamp pin (G) Pin 3; Primary color signal clamp pin (B): For the clamp pulse, the internal clamp pulse (BGP) is used.</p> | <p>DC approx. 7 V</p> |
| 4 | | <p>Killer filter pin: Filter pin of killer detection circuit (operates for BGP period). Killer turns on (without color output) at a voltage of 2.8 V or lower.</p> | <p>DC approx. 3.3 V</p> |
| 5 | | <p>Killer, 50 Hz/60 Hz, SECAM det. output pin: Selective output by SW (I²C bus). The load resistance 33 kΩ should be connected to microcomputer V_{CC}.</p> | <p>DC Low level 0.2 V High level 5 V</p> |
| 6 | | <p>APC filter pin: Filter pin of APC detection circuit (operates for BGP period). The detection sensitivity becomes high when the external resistance is high, (tend to be pulled-in easily. tend to be influenced by noise). Stop APC circuit by short-circuiting 40 kΩ at SECAM.</p> | <p>DC approx. 2.5 V</p> |



■ Terminal Equivalent Circuits (continued)

| Pin No. | Equivalent circuit | Description | voltage |
|---------|--------------------|---|---|
| 7 8 | | <p>Pin 7; Chroma. oscillation pin (4.43 MHz) Pin 8; Chroma. oscillation pin (3.58 MHz): Either one of the oscillations of 4.43 MHz or 3.58 MHz is performed by chroma. oscillation pin. Frequency changeover is carried out by 08-D7 bit of I²C bus. When 08-D7 = 0; I_{P1}, I_{P2} turn on, and 4.43 MHz oscillates When 08-D7 = 1; I_{N1}, I_{N2} turn on and 3.58 MHz oscillates The pattern from pin to oscillator should be as short as possible.</p> | <p>AC f = f_C approx. 0.7 V[p-p]</p> |
| 9 | | <p>Black level detection pin Blanking off SW pin: Black level detection filter pin for black extension circuit. Excluding the blanking period, holds the most black Y level. The sensitivity that the black extension (area judged as black) comes work is variable by means of external R. When R is large, it responds to a small area. Apply V_{CC} (9 V) to pin 9 when stopping the black extension circuit. Blanking is turned off when pin 9 is GND (black extension is also off).</p> | <p>DC approx. 5.1 V</p> |
| 10 | | <p>Y_S input pin: Fast-blanking pulse input pin for external analog R, G, B. On at a voltage over 1 V. Off at a voltage under 0.4 V.</p> | <p>AC (pulse)</p> |

■ Terminal Equivalent Circuits (continued)

| Pin No. | Equivalent circuit | Description | voltage | |
|----------------|--------------------|--|---|---|
| 11 12 13 | | <p>Pin11; External R input pin Pin12; External G input pin Pin13; External B input pin: The output will change linearly depending on the input level.</p> | AC | |
| 14 | — | <p>V_{CC1} (9 V typ.): Output block of VIF, SIF circuit. AV SW circuit. Video circuit. RGB circuit.</p> | DC 9 V | |
| 15 16 17 | | <p>Pin15; R-out pin Pin16; G-out pin Pin17; B-out pin: BLK level approx. 0.9 V. Black (pedestal) level approx. 2.2 V. Blanking can be released by setting pin 9 (black level detection pin) at 0 V.</p> | | AC |
| 18 | | <p>Horizontal synchron. detection pin: The phase of horizontal sync. signal and horizontal output pulse is detected and outputted. Pin 18 becomes low if out of synchronization. Color control becomes minimum and chroma signal disappears in asynchronous state. Pay attention to impedance when the voltage of pin 18 is utilized for microcomputer. (500 kΩ or higher Z_O is required)</p> | <p>When pin 56 is high: I₁ on When pin 56 is low: I₂ on</p> | DC When synchronous approx. 6 V When asynchronous approx. 0.3 V |

■ Terminal Equivalent Circuits (continued)

| Pin No. | Equivalent circuit | Description | voltage |
|---------|--------------------|--|-------------------|
| 19 | — | GND: R, G, B circuit. DAC, I ² C circuit. | — |
| 20 | | ACL pin: If DC voltage of pin 20 is decreased from the outside, the contrast is turned down. Service SW. Note) Since pin 20 also serves as the service SW when used as ALC, design the set so as not to allow $V_{20} < 0.9$ V. | DC approx. 3 V |
| 21 | | I ² C bus data input pin | AC (pulse) |
| 22 | | I ² C clock input pin | AC (pulse) |
| 23 | — | V _{CC3} -1 (5 V typ.): For VIF and SIF circuitr. | DC 5 V |

■ Terminal Equivalent Circuits (continued)

| Pin No. | Equivalent circuit | Description | voltage |
|----------|--------------------|--|---|
| 24 25 | | <p>Pin24; VIF input pin-1 Pin25; VIF input pin-2: Balanced input by VIF amp. input.</p> | <p>AC $f = f_p$ DC level approx. 2.7 V</p> |
| 26 | — | <p>GND: For VIF and SIF circuit.</p> | DC |
| 27 | | <p>RF AGC output pin: Open collector output and usable at any bias value (12 V max.).</p> | DC |
| 28 | | <p>Audio output pin</p> | <p>AC 0 kHz to 20 kHz</p> |
| 29 | | <p>De-emphasis pin: De-emphasis filter pin for sound detection signal. External C for PAL/NTSC is the same (internal impedance changes). PAL: $12\text{ k}\Omega // 60\text{ k}\Omega \times 1\ 200\text{ pF} = 48\ \mu\text{s}$ NTSC: $60\text{ k}\Omega \times 1\ 200\text{ pF} = 72\ \mu\text{s}$</p> | <p>AC 0 kHz to 20 kHz</p> |

■ Terminal Equivalent Circuits (continued)

| Pin No. | Equivalent circuit | Description | voltage |
|---------|--------------------|--|--|
| 30 | | <p>AFT output pin: Offset of center voltage is adjusted by using bus. When AFT defeat SW is turned on (09 = 00), V_{30} becomes a value determined by external resistor-divider. μ of AFT is variable by impedance of external resistor.</p> | DC |
| 31 | | <p>External video input signal pin: External video signal input pin and DC cut input. Typical 1 V[p-p].</p> | <p>AC 1 V[p-p] (compost)</p> <p>DC approx. 2.0 V</p> |
| 32 | | <p>Decoupling pin: S-curve inside the IC is broad-band. However, DC feedback should be applied so that DC voltage of output signal becomes constant. DC level (4.5 V typ.). $f_S \rightarrow$ high: $V_{32} \rightarrow$ low</p> | DC |
| 33 | | <p>SIF signal input pin: Used in common as DC input pin for sharpness control. DC bias is applied from outside (for sharpness control DC: 5 V to 7 V).</p> | <p>AC+DC AC $f = f_S$</p> |

■ Terminal Equivalent Circuits (continued)

| Pin No. | Equivalent circuit | Description | voltage |
|---------|--------------------|---|--|
| 34 | | SIF internal power supply stabilization filter pin | DC 1.24 V |
| 35 | | SIF signal input pin: Input pin for SIF2 and internally biased. | AC+DC AC $f = f_s$ DC 3.0 V |
| 36 | | SIF signal input pin: Input pin for SIF1 and internally biased. | |
| 37 | | IF AGC filter pin: IF AGC filter pin. The current obtained from peak AGC circuit is smoothed by an external capacitor. When C goes smaller, the respons characteristic becomes faster but the sag tends to appear easily. | DC approx. 2 V |
| 38 | | Internal video input pin 1: Input pin for the signal detected by VIF circuit (internal video signal). DC cut input. Typical 1 V[p-p] | AC 1 V[p-p] (compost) DC level approx. 1.6 V |

■ Terminal Equivalent Circuits (continued)

| Pin No. | Equivalent circuit | Description | voltage |
|---------|--------------------|--|---|
| 39 | | <p>SIF APC filter pin: Filter pin for SIF APC circuit.</p> | DC |
| 40 | | <p>Internal video input pin 2: Input pin for the signal detected by VIF circuit (internal video signal). DC cut input. Typical 1 V [p-p].</p> | <p>AC 1 V [p-p] (compost) DC level approx. 1.6 V</p> |
| 41 | | <p>VIF detection output pin: Adjust at 2 V [p-p] by I²C bus (upper 4-bit of 0 A is used).</p> <p>Note) At AV mode, VIF detection signal output is not given.</p> | <p>AC 2 V [p-p] DC level approx. 1.6 V</p> |
| 42 | | <p>APC1 filter pin: Filter pin for APC1 circuit of VIF. Lock detection circuit of VCO is built in the IC inside and the time constant of APC filter is changed over. When locked SW: 0 When not locked SW: 1</p> | <p>DC approx. 2.5 V</p> |

■ Terminal Equivalent Circuits (continued)

| Pin No. | Equivalent circuit | Description | voltage |
|---------|--------------------|---|--|
| 43 | | <p>VIF oscillation pin: Depending on VIF frequency, change oscillation coil. The oscillation frequency is 1/2 of f_p.</p> | <p>AC $f = f_p/2$ approx. 0.7 V[p-p] DC level approx. 3.9 V</p> |
| 44 | | <p>Video output pin: This pin outputs int. video 1, int. video 2 or ext. video signal selected by AV SW.</p> | <p>AC 2 V[p-p] DC level approx. 4.5 V</p> |
| 45 | | <p>Video input pin: Input pin for video signal (composite video also available). Typical input 0.6 V[p-p]. Sync. top is clamped at 3.5 V. The video signal should be inputted with low impedance.</p> | <p>AC 0.6 V[p-p] DC level approx. 4.5 V</p> |
| 46 | | <p>Vertical and horizontal sync. separation input pin: Sync. top is clamped at 1.3 V.</p> | <p>AC 2 V[p-p] DC level approx. 4.5 V</p> |
| 47 | <p>—</p> | <p>V_{CC3-2} (5 V typ.) For chroma jungle circuit.</p> | <p>DC 5 V</p> |

■ Terminal Equivalent Circuits (continued)

| Pin No. | Equivalent circuit | Description | voltage |
|---------|--------------------|--|--|
| 48 | | <p>Chroma signal input pin</p> <p>Black extension start point adjusting pin:</p> <p>Pin 48 is chroma signal input pin, and the black extension start point is adjusted by DC voltage applied from the outside.</p> | <p>AC+DC burst</p> <p>150mV[p-p] typ.</p> <p>DC 4.5 V typ.</p> |
| 49 | | <p>GND:</p> <p>For video chroma jungle circuit.</p> | <p>DC 0 V</p> |
| 50 | | <p>FBP input pin:</p> <p>FBP input pin for horizontal blanking and AFC circuit.</p> <p>Threshold level</p> <p>H-BLK: 0.7 V</p> <p>AFC: 1.9 V</p> <p>It becomes all blanking when DC 1.3 V is applied from the outside.</p> | <p>AC FBP</p> |
| 51 | | <p>Horizontal stabilized power supply pin:</p> <p>Stabilized power supply for starting up the horizontal circuit that has a zener circuit inside.</p> | <p>DC 6.3 V</p> |
| 52 | | <p>Horizontal AFC2 filter pin:</p> <p>Comparing the phase of FBP and that of inside pulse of the IC, charge to and discharge from the capacitor connected to pin 52 are done.</p> <p>Performed by charging and discharging in DC current by the screen center position adjusting DAC.</p> <p>V_{52} changes depending on the time from H-out to FBP, and the slice level of internal sawtooth waveform changes.</p> | <p>DC 1.5 V to 3.5 V</p> |

■ Terminal Equivalent Circuits (continued)

| Pin No. | Equivalent circuit | Description | voltage |
|---------|--------------------|---|---|
| 53 | | <p>Horizontal AFC1 filter pin: Comparing the phase of horizontal sync. signal and that of inside pulse of the IC, charge to and discharge from the capacitor connected to pin 53 are done. R1, R2, C1, and C2 are lag-lead filter for AFC1.</p> | <p>DC 4.3 V typ.</p> |
| 54 | | <p>Horizontal oscillation pin: Oscillate at $32 \times f_H \approx 503$ kHz by means of ceramic oscillator. Horizontal and vertical pulse are generated by means of count down circuit in the IC.</p> | <p>AC $f = 32 f_H$ (approx.) (503 kHz)</p> |
| 55 | | <p>Overvoltage protection input pin: Input pin for the protect circuit against X-ray due to overvoltage. Shut-down is started by internal logic circuit when H-out pulse is low. (Prevent the horizontal drive Tr destruction.)</p> | <p>DC normally 0 V</p> |
| 56 | | <p>Horizontal pulse output pin: Duty cycle is approx. 36%.</p> | <p>AC pulse</p> |

■ Terminal Equivalent Circuits (continued)

| Pin No. | Equivalent circuit | Description | voltage |
|----------|--------------------|--|--|
| 57 | | <p>Vertical sync. signal clamp pin: Peak clamp pin for separating vertical sync. signal.</p> <p>Although the integral amount of vertical sync. signal itself has been determined by the internal time constant, the trigger application timing is determined by selecting external constant R1, C1. R1 must be used at higher than 200 kΩ. R2 is resistor for emitter current restriction.</p> | <p>AC $f = f_v$</p> |
| 58 | | <p>Vertical pulse output pin: Negative polarity, pulse width of 10H.</p> | <p>AC pulse</p> |
| 59 | | <p>SECAM interface pin: Input and output pin for interfacing with SECAM IC.</p> <p>It becomes the SECAM mode when the current sink from pin 59 is 100 μA or more.</p> <p>At SECAM DC 4.4 V + AC 250 mV[p-p]</p> <p>At non-SECAM DC 1.1 V + AC 250 mV[p-p]: 4.43 MHz or 0 mV[p-p]: 3.58 MHz</p> | <p>AC+DC AC 250 mV[p-p] or 0 mV[p-p] DC 4.4 V or 1.1 V</p> |
| 60 61 | | <p>Pin60; -(B-Y) output pin Pin61; -(R-Y) output pin:</p> <p>The output circuit turns off at SECAM and becomes a high impedance state. Outputs to 1HDL.</p> | <p>AC -(B-Y) -(R-Y) DC level approx. 2.1 V</p> |

■ Terminal Equivalent Circuits (continued)

| Pin No. | Equivalent circuit | Description | voltage |
|----------|--------------------|--|---|
| 62 | | <p>Sand-castle pulse output pin: The sand-castle pulse is outputted to 1HDL and SECAM IC.</p> | <p>AC pulse</p> |
| 63 64 | | <p>Pin63; -(B-Y) input pin Pin64; -(R-Y) input pin: The color difference signal outputted from 1HDL is inputted. The pedestal level is clamped at 4 V by means of clamp circuit.</p> | <p>AC -(B-Y) -(R-Y)</p> <p>DC level 4 V</p> |

■ Usage Notes

1. The following terminals are not strongly resistant to surge latch-up. The precautions should be observed when using the IC.

1) Serge

The + side breakdown voltage of pin 22 and pin 23 is approx. 190 V if the surge source capacitance is 200 pF.
The + side breakdown voltage of pin 45 is approx. 160 V if the surge source capacitance is 200 pF.
Therefore, do not apply a surge stronger than that.

2) Latch-up

For pin 18, pin 21, pin 22, pin 51, pin 54, pin 55 and pin 56, the latch-up occurs by the + side surge of approx. 150 V (surge source capacitance 200 pF). Therefore, do not apply a surge stronger than each voltage indicated for each pin.

Note) The stronger surge common to the above 1) and 2) means that the establishment of either one of the following two cases; the surge source capacitance is larger than the indicated value or the surge voltage is higher than the indicated value.

■ Usage Notes (continued)

2. The protection diode of each Pin is as shown in the following table;

| | Pin | 1 | 2 | 3 | 4 | 5 | 6 | 7 | 8 | 9 | 10 | 11 | 12 | 13 | 14 | 15 | 16 | 17 | 18 | 19 | 20 | 21 | 22 | 23 | 24 | 25 | 26 |
|--------------------------------------|-----------------|---|---|---|---|---|---|---|---|---|----|----|----|----|----|----|----|----|----|----|----|----|----|----|----|----|----|
| With (●) or Without | V _{CC} | ● | ● | ● | ● | ● | ● | ● | ● | ● | ● | ● | ● | ● | × | ● | ● | ● | ● | × | ● | × | × | × | ● | ● | × |
| (×) Surge diode | GND | ● | ● | ● | ● | ● | ● | ● | ● | ● | ● | ● | ● | × | ● | ● | ● | ● | ● | × | ● | × | × | × | ● | ● | × |
| V _{CC} node being connected | | 1 | 1 | 1 | 3 | 3 | 3 | 3 | 3 | 1 | 1 | 1 | 1 | 1 | / | 1 | 1 | 1 | 2 | / | 1 | / | / | / | 3 | 3 | / |

| | Pin | 27 | 28 | 29 | 30 | 31 | 32 | 33 | 34 | 35 | 36 | 37 | 38 | 39 | 40 | 41 | 42 | 43 | 44 | 45 | 46 | 47 | 48 | 49 | 50 | 51 | 52 |
|--------------------------------------|-----------------|----|----|----|----|----|----|----|----|----|----|----|----|----|----|----|----|----|----|----|----|----|----|----|----|----|----|
| With (●) or Without | V _{CC} | ● | ● | ● | ● | ● | ● | ● | ● | ● | ● | ● | ● | ● | ● | ● | ● | ● | ● | ● | ● | × | ● | × | ● | × | ● |
| (×) Surge diode | GND | ● | ● | ● | ● | ● | ● | ● | ● | ● | ● | ● | ● | ● | ● | ● | ● | ● | ● | ● | ● | × | ● | × | ● | × | ● |
| V _{CC} node being connected | | 1 | 1 | 1 | 1 | 1 | 1 | 1 | 3 | 1 | 1 | 3 | 1 | 1 | 1 | 1 | 3 | 3 | 3 | 1 | 1 | / | 3 | / | 3 | / | 2 |

| | Pin | 53 | 54 | 55 | 56 | 57 | 58 | 59 | 60 | 61 | 62 | 63 | 64 |
|--------------------------------------|-----------------|----|----|----|----|----|----|----|----|----|----|----|----|
| With (●) or Without | V _{CC} | ● | ● | ● | ● | ● | ● | ● | ● | ● | ● | ● | ● |
| (×) Surge diode | GND | ● | ● | ● | ● | ● | ● | ● | ● | ● | ● | ● | ● |
| V _{CC} node being connected | | 2 | 2 | 2 | 2 | 3 | 3 | 1 | 3 | 3 | 3 | 1 | 1 |

V_{CC} node
 1 → V_{CC1} (9 V system)
 2 → V_{CC2} (6.5 V system)
 3 → V_{CC3} (5 V system)

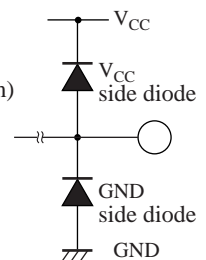

■ Technical Information

• Explanation of each block

1. VIF

- 1) Adapting the inter carrier PLL coherent detection method.
- 2) The VCO of VIF is controlled by I²C bus (7-bit): Oscillation at 1/2 of the f_p frequency. (2 times multiplier circuit is inside.) Built-in double APC circuit of frequency and phase.
- 3) AFT without coil: It is applicable to both VS and FS tuners by amplifying the error voltage of APC and making S-curve to obtain AFT output. The DC offset is controlled by I²C bus (9-bit). The AFT defeat is also possible.
- 4) Since the VCO oscillates at 1/2 frequency, a high-frequency disturbance such as tweet is reduced.
- 5) The video detection output is 2.0 V[p-p] typical: The level adjustment is carried out by I²C bus.
- 6) The built-in lock detection circuit realizes a stable pulling by the changeover of time constant for APC.
- 7) The delay point of RF AGC is adjusted by I²C bus (6-bit).

2. SIF

- 1) The SIF detection uses PLL coherent detection method.
- 2) 4 frequencies are changed over for use as the VCO oscillation frequency.
 - At NTSC; 4.5 MHz
 - At PAL; 5.0 MHz, 5.5 MHz, 6.5 MHz
- 3) It is possible for the SIF detection output to deal with the difference in deviation of PAL/NTSC by changing over an amplifier of +6 dB.
- 4) Built-in video/SIF SW.
 - Video SW; 2 systems (with 6 dB amp.)
 - SIFSW; 3 systems

■ Technical Information (continued)

• Explanation of each block (continued)

3. Video

- 1) The delay line aperture control (contours emphasis type) is used for sharpness control. The circuit as well as the black extension circuit realizes a high picture quality.
- 2) Built-in pedestal clamp filter.
- 3) Service SW: (Y contrast min., vertical output stop).

4. Chroma

- 1) The circuit realizes an adjustment free condition by using base band IHDL (externally attached).
- 2) Incorporation of ACC filter reduces the number of external components.
- 3) It is possible to support the other systems by the mode changeover I²C bus (1) PAL/NTSC, (2) 4.43 MHz/3.58 MHz, (3) Forced PN/ForcedSECAM.
- 4) Equipped with the killer output terminal for system discrimination by microcomputer. (When killer is on → 0 V, killer is off → 5 V)
- 5) The color difference output terminal becomes a high impedance state at SECAM.
- 6) Since the circuit is provided with the color difference input terminal, the features of ICs such as the AN5244 (IC for color signal compensation) can be connected.
- 7) PAL/NTSC, SECAM interface (pin 59)

| Mode | DAC(3.58 MHz/4.43 MHz) | Pin59 output | f _c | AC level | |
|----------|------------------------|---------------|----------------|-------------|----------------------------------|
| PAL/NTSC | 3.58 MHz | Approx. 1.3 V | 3.58 MHz | × | CW output |
| | 4.43 MHz | Approx. 1.3 V | 4.43 MHz | 250 mV[p-p] | |
| SECAM | 3.58 MHz | Approx. 4.6 V | 4.43 MHz | 250 mV[p-p] | Output for V-blank period only * |
| | 4.43 MHz | Approx. 4.6 V | 4.43 MHz | 250mV[p-p] | |

Note) *: AC component of 4.43 MHz is outputted in the vertical sweep period only.

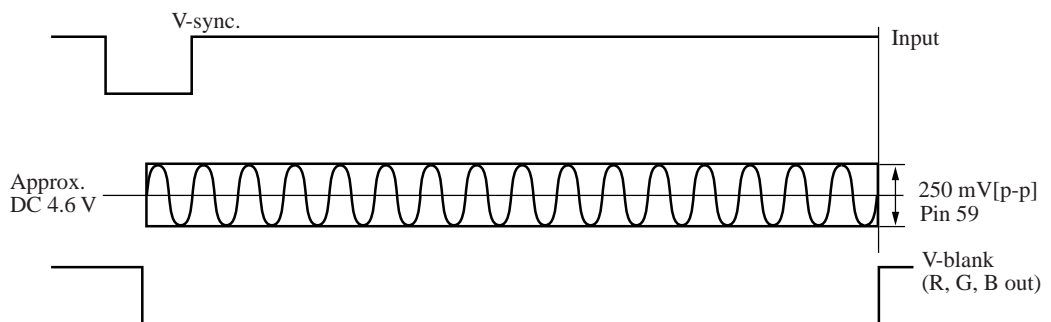

5. RGB

- 1) It supports not only the OSD but also the teletext signal in an analog input system. (The output level is interlocked with the contrast of TV signal side.)
- 2) The white balance (drive, cut-off) adjustment is performed by I²C bus.

6. Jungle

- 1) The horizontal circuit uses the count down method by 32 f_H ceramic oscillator. The AFC circuit uses double method.
- 2) By the adaption of trigger method count down circuit, the vertical circuit can obtain a stable vertical synchronization without adjustment at all times. The output is pulse signal, so that there is no degradation of interface due to the influence of pattern layout.

■ Technical Information (continued)

• Explanation of each block (continued)

6. Jungle (continued)

- 3) Built-in frequency discrimination circuit: The circuit outputs the judgment results of 50 Hz/60 Hz in accordance with the frequency of the vertical synchronizing signal.

(60 Hz → high)

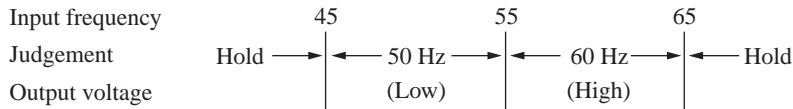

- 4) The output holds the previous state when the input frequency is 45 Hz or less and 65 Hz or more, and the output changes for the first time when judged as 50 Hz or 60 Hz for 3 consecutive vertical periods.
- 5) The horizontal detection circuit and X-ray protection circuit (shut-down method) are built in.
- 6) The screen center position is adjustable by the I²C bus. ($\pm 1.6 \mu\text{s}$)
- 7) For the blue-back in a weak electric field, the stable screen image is held by the vertical trigger off mode (I²C bus).

7. I²C bus

- 1) Incorporating 14 DAC controls and 12 SWs for eliminating the need for the adjustment of set mechanism.
- 2) Provided with automatic increment function.
- Sub address 0 *: Automatic increment mode.
(When data are sent in regular succession, sub address changes successively and data are inputted.)
 - Sub address 8 *:
(When data are sent in regular succession, data are inputted with the same sub address.)
- 3) I²C Bus Protocol
- Slave address: 10 001 010 (8AH)
 - Slave address format

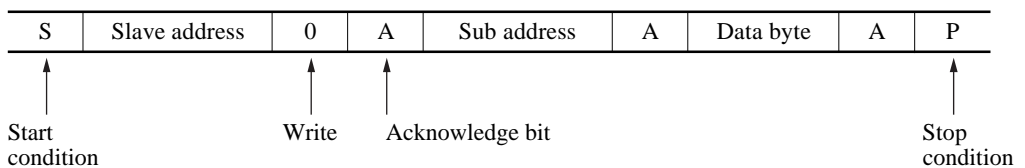

- 4) Sub address byte and data byte format
 The description in () shows the initial state.

| Sub address | Data byte | | | | | | | |
|-------------|-------------------------|--------------------------|----|----|------------|----|----|----|
| | D7 | D6 | D5 | D4 | D3 | D2 | D1 | D0 |
| 00 (21H) | P/N (0 → P) | PN/S (0 → PN) | ← | | Color | | | → |
| 01 (21H) | Ver. auto (0 → auto) | Ver. TRG (0 → normal) | ← | | Tint | | | → |
| 02 (41H) | Ver. OSC (0 → 50) | | ← | | Brightness | | | → |
| 03 (21H) | SIF SW | Video SW | ← | | Contrast | | | → |
| 04 (81H) | ← | | | | Cut off R | | | → |
| 05 (81H) | ← | | | | Cut off G | | | → |
| 06 (81H) | ← | | | | Cut off B | | | → |

■ Technical Information (continued)

• Explanation of each block (continued)

7. I²C bus (continued)

4) Sub address byte and data byte format (continued)

The description in () shows the initial state.

| Sub address | Data byte | | | | | | | |
|-------------|---------------------------------|------------------|-----------------|----|----|-----------------|----|----------|
| | D7 | D6 | D5 | D4 | D3 | D2 | D1 | D0 |
| 07 (41H) | SIF VCO SW1 | ← | | | | Drive R | | → |
| 08 (41H) | Chroma VCO (0 → 4.43) | ← | | | | Drive B | | → |
| 09 (01H) | | ← | | | | AFT offset | | → |
| 0A (21H) | 50 Hz/60 Hz killer out SW | SECAM det. SW | ← | | | RF AGC delay | | → |
| 0B (45H) | SIF/ext. SW | ← | Video adjust | → | | SIF VCO SW2 | ← | H center |
| 0C (C1H) | AFT offset SW | ← | | | | VIF VCO | | → |

5) Contents of I²C bus control

(1) The control information is in the direction that the output increases when the datum increases.

(Example: Contrast 00 → contrast min. , 3F → max. , brightness 00 → pedestal level low, 7F → high)

(2) Supplement of other control

a. 00: Color

When data are 00, the color becomes off since the chroma output is decreased completely .

b. 01: Tint

Data 00 → Skin color tends to become reddish, 3F → skin color tends to become greenish.

c. 04, 05, 06: Cut off R, G, B

8-bit DAC

d. 07, 08: Driver R, B

7-bit DAC

e. 09: AFT offset adjustment

The DC offset of S-curve of AFT output is corrected.

Data 01 → S-curve falls (DC voltage of center frequency drops).

Data FF → S-curve rises.

It becomes AFT defeat mode when data 00, the voltage of AFT out (pin 30) becomes the value in accordance with the external resistor.

AFT changes over 8-bit DAC into 2 stages for variable range and improvement of precision for per 1-bit.

Example: In the case of AFT

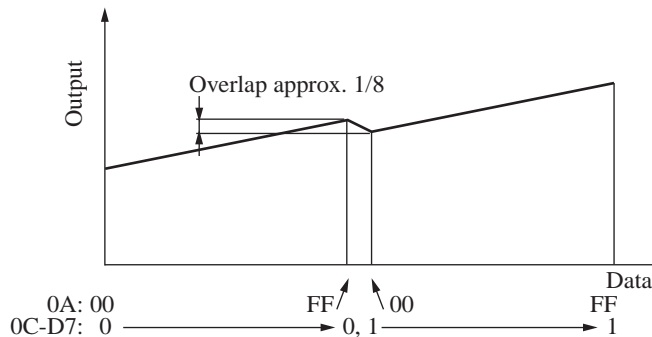

■ Technical Information (continued)

• Explanation of each block (continued)

7. I²C bus (continued)

5) Contents of I²C bus control (continued)

(2) Supplement of other control (continued)

f. 0A: RF AGC delay point adjustment

The same operation as when bias is applied from outside conventionally.

Data 00 → DC-applied bias drops → delay point rises

Data 3F → DC-applied bias drops → delay point down

g. 0B: Video adjustment

Data 0* → detection output min. 7* → max. to be used for correcting the dispersion of detection output inside the IC.

h. 0B: Hor. screen image position

Data *0 → screen image goes to the left 7 * → screen image shifts to the right.

i. 0C: VCO control

Fine control for the oscillation frequency of VCO (1/2 frequency of f_p) of VIF.

8. Supplementary explanation of SW operation

| Data-bit | SW contents | Concrete contents | | |
|----------------|---|--|---------------|---------------------|
| 00-D7 | PAL/NTSC mode SW (0 → PAL) (1 → NTSC) | 1) BGP width changeover (PAL: Wide) 2) CW changeover to killer (PAL: 90 deg./270 deg.) 3) Tint operation changeover (PAL: Tint off) 4) Ident operation changeover (PAL: With operation) | | |
| 00-D6 | PAL, NTSC/SECAM mode SW (1 → forced SECAM) (0 → normal discrimination mode) | 1) Demodulation output mode changeover. The color difference output terminal becomes high impedance at forced SECAM. | | |
| 01-D7 | Ver. auto SW (0 → auto changeover) (1 → manual changeover) | 1) Vertical frequency discrimination circuit changeover. Auto changeover: Automatic discrimination mode by internal counter. Manual changeover: Forcibly changeover 50 Hz/60 Hz by 02-D7 data. | | |
| 01-D6 | Ver. TRG stop SW (0 → normal) (1 → trigger off) | 1) Vertical trigger input inhibit SW. 1 → trigger input-off is the mode to protect from the vertical dancing caused by noise at blue-back . | | |
| 02-D7 | Ver. OSC SW (0 → 50 Hz) (1 → 60 Hz) | 1) Vertical frequency changeover SW. Valid only when 01-D7 is 1. | | |
| 03-D7 0B-D7 | SIF, external AV input changeover switch | | | |
| | 03-D7 | 0B-D7 | Output signal | |
| | 0 | 0 | SIF1 (int.) | Power on time |
| | 0 | 1 | SIF2 (int.) | |
| | 1 | 0 | SIF3 (int.) | |
| | 1 | 1 | Ext. (video) | Int. is set at SIF1 |

■ Technical Information (continued)

• Explanation of each block (continued)

8. Supplementary explanation of SW operation (continued)

| Data-bit | SW contents | Concrete contents | | | |
|----------------|--|--|------------------|------------------------------|--------------------|
| 03-D6 | Video input changeover switch | | | | |
| | 03-D6 | Input signal | | | |
| | 0 | Video1 | Power on time | | |
| | 1 | Video2 | | | |
| 08-D7 | Chroma VCO SW (0 → 4.43 MHz) (1 → 3.58 MHz) | 1) Chroma oscillation circuit changeover. | | | |
| 0A-D7 0A-D6 | 50 Hz/60 Hz, killer, SECAM det. out switch | | | | |
| | 0A-D6 | 0A-D7 | Output signal | | |
| | 0 | 0 | 50 Hz/60 Hz out | Power on time | |
| | 0 | 1 | Killer out | | |
| | 1 | 0 | SECAM det. out | | |
| | Output | Mode | 50 Hz/60 Hz out | Killer out | SECAM det. out |
| | H (5 V) | | 60 Hz | Off (color) | SECAM |
| | L (0 V) | | 50 Hz | On (B/W) | No SECAM |
| 07-D7 0B-D3 | SIF VCO free-running frequency, de-emphasis Detection output gain changeover switch | | | | |
| | 07-D7 | 0B-D3 | De-emphasis/gain | Oscillation frequency of VCO | SIF input terminal |
| | 1 | 0 | NTSC | 4.5 MHz (power on time) | — |
| | 1 | 1 | PAL | 5.5 MHz | — |
| | 0 | 0 | PAL | 6.0 MHz | — |
| | 0 | 1 | PAL | 6.5 MHz | — |
| 0C-D7 | AFT offset SW (0 → without offset) (1 → with offset) | 1) For AFT 2-stage changeover. (Power on preset: AFT offset SW → 1) 2) AFT defeat. Defeat comes effective only when 0C-D7 = 0, DAC(09) = 00. | | | |

Application Circuit Example

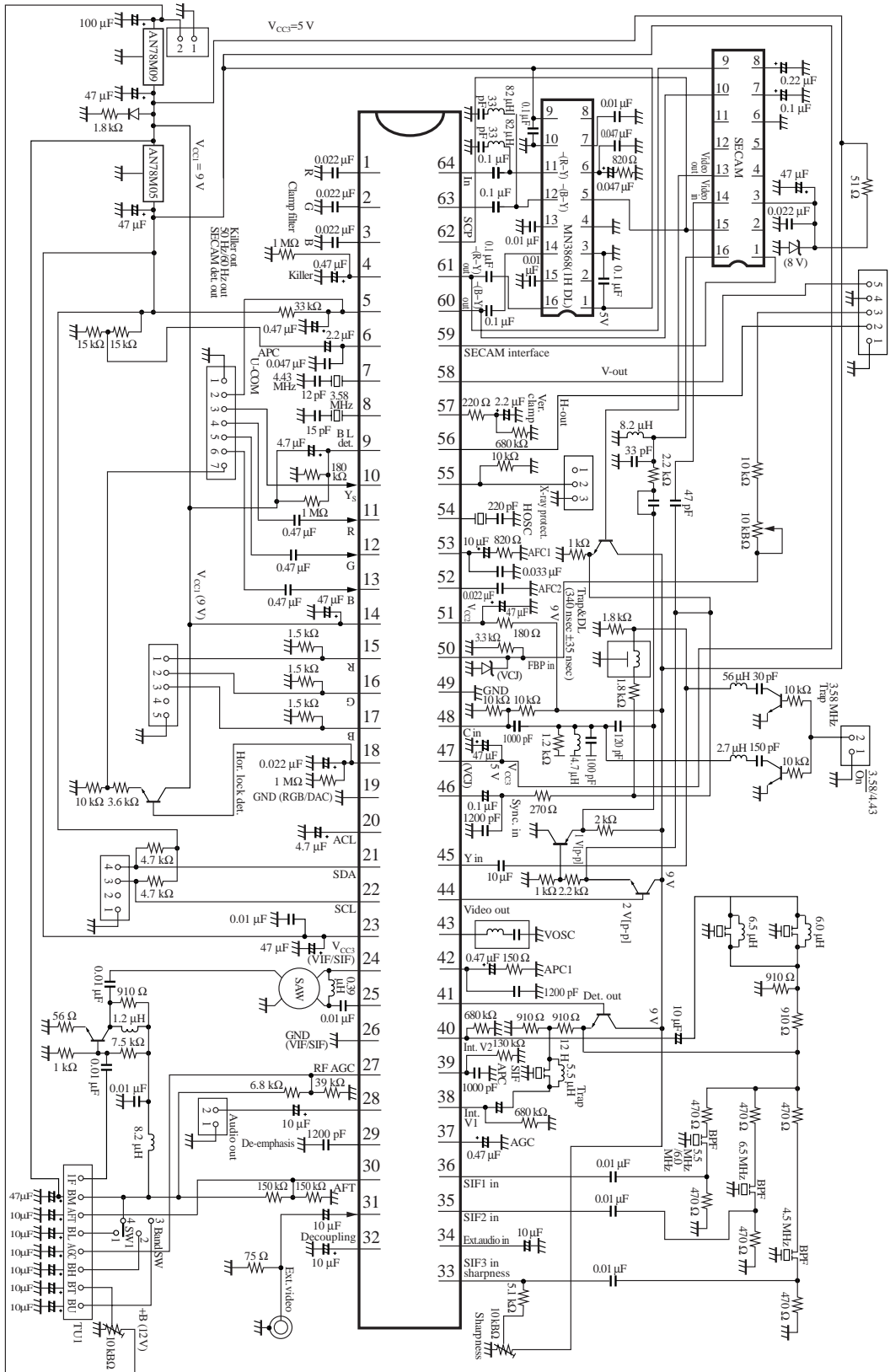



LittleDiode supplies new, hard to find or obsolete electronic components and semiconductors all over the world.

With over two million different components listed you are sure to find the part you need.

Feel free to visit us today at our online store:

LittleDiode.com

Looking forward to providing you with the best possible service.