

# AN48840B

Low current consumption, high sensitivity CMOS Hall IC  
 Alternating magnetic field operation  
 (For low-speed rotation detection)

## Overview

The AN48840B is a Hall ICs (a magnetic sensor) which has 2 times or more sensitivity and a low current consumption of about one fiftieth compared with our conventional one.

In this Hall IC, a Hall element, a offset cancel circuit, an amplifier circuit, a sample and hold circuit, a Schmidt circuit, and output stage FET are integrated on a single chip housed in a small package by IC technique.

## Features

- High sensitivity due to offset cancel circuit and a new sample and hold circuit
- Small current by using intermittent action  
 (Average supply current: 56  $\mu$ A typ., Sampling period: 670  $\mu$ s typ.)
- Small package (SMD)
- CMOS inverter output (logic output form)

## Applications

- Functional operation key, Mouse,  
 Appliances for low-speed rotation detection

## Block Diagram

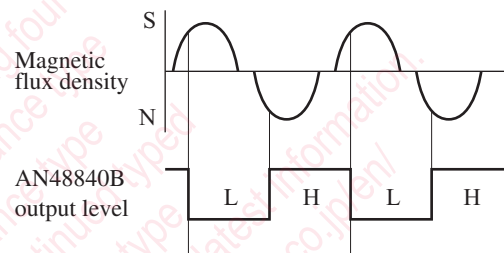
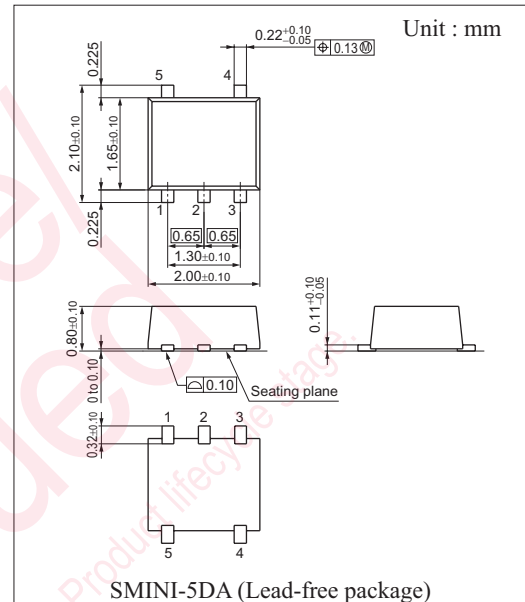
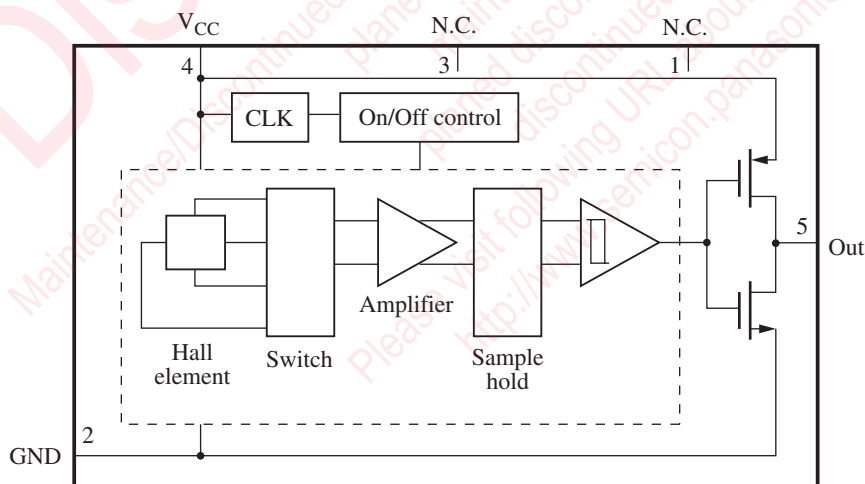

## Pin Descriptions

Pin No.	Symbol	Description	Pin No.	Symbol	Description
1	N.C.	—	4	V <sub>CC</sub>	Power supply
2	GND	Ground	5	Out	Output
3	N.C.	—			

### ■ Absolute Maximum Ratings

Parameter	Symbol	Rating	Unit
Supply voltage	$V_{CC}$	5	V
Output voltage	$V_{OUT}$	5	V
Supply current	$I_{CC}$	5	mA
Output current	$I_{OUT}$	15	mA
Power dissipation *1, *2	$P_D$	60	mW
Operating ambient temperature *1	$T_{opr}$	-25 to +75	°C
Storage temperature *1	$T_{stg}$	-55 to +125	°C

Note) \*1: Except for the power dissipation, operating ambient temperature and storage temperature, all ratings are for  $T_a = 25^\circ\text{C}$ .

\*2:  $T_a = 75^\circ\text{C}$ . For the independent IC without a heat sink. Please use within the range of power dissipation, referring to  $P_D - T_a$  curve.

### ■ Recommended Operating Range

Parameter	Symbol	Range	Unit
Supply voltage	$V_{CC}$	2.5 to 3.5	V

### ■ Electrical Characteristics $T_a = 25^\circ\text{C} \pm 2^\circ\text{C}$

Parameter	Symbol	Conditions	Min	Typ	Max	Unit
Operating magnetic flux density 1 *1	$B_{HL}$	$V_{CC} = 3\text{ V}, V_{CC} = 2.5\text{ V}$	0.5	—	6	mT
Operating magnetic flux density 2 *2	$B_{LH}$	$V_{CC} = 3\text{ V}, V_{CC} = 2.5\text{ V}$	-6	—	-0.5	mT
Output voltage 1	$V_{OL1}$	$V_{CC} = 3\text{ V}, I_O = 2\text{ mA}, B = 6.0\text{ mT}$	—	0.1	0.3	V
Output voltage 1	$V_{OL2}$	$V_{CC} = 2.5\text{ V}, I_O = 2\text{ mA}, B = 6.0\text{ mT}$	—	0.1	0.3	V
Output voltage 2	$V_{OH1}$	$V_{CC} = 3\text{ V}, I_O = -2\text{ mA}, B = -6.0\text{ mT}$	2.7	2.9	—	V
Output voltage 2	$V_{OH2}$	$V_{CC} = 2.5\text{ V}, I_O = -2\text{ mA}, B = -6.0\text{ mT}$	2.7	2.9	—	V
Supply current 1 *3	$I_{CCAVE}$	$V_{CC} = 3\text{ V}$	—	56.0	85.0	$\mu\text{A}$
Supply current 2 *3	$I_{CC2AVE}$	$V_{CC} = 2.5\text{ V}$	—	48.0	72.0	$\mu\text{A}$
Intermittent action time	$T_{sam}$	$V_{CC} = 3\text{ V}$	490	670	850	$\mu\text{S}$
Intermittent action time 2	$T_{sam2}$	$V_{CC} = 2.5\text{ V}$	513	710	890	$\mu\text{S}$

Note) \*1: Symbol  $B_{H-LS}$ ,  $B_{H-LN}$  stands for the operating magnetic flux density where its output level varies from high to low.

\*2: Symbol  $B_{L-HS}$ ,  $B_{L-HN}$  stands for the operating magnetic flux density where its output level varies from low to high.

\*3:  $I_{CCAVE} = \{I_{CCON} \times t_{ON} + I_{CCOFF} \times t_{OFF}\} / \{t_{ON} + t_{OFF}\}$

### • Design reference data

Parameter	Symbol	Conditions	Min	Typ	Max	Unit
Hysteresis width	BW	$V_{CC} = 3\text{ V}$	—	7	—	mT
Supply current 3	$I_{CCON}$	$V_{CC} = 3\text{ V}$	—	1.4	2.1	mA
Supply current 4	$I_{CCOFF}$	$V_{CC} = 3\text{ V}$	—	2.5	—	$\mu\text{A}$
Supply current 5	$I_{CC2ON}$	$V_{CC} = 2.5\text{ V}$	—	1.12	1.68	mA
Supply current 6	$I_{CC2OFF}$	$V_{CC} = 2.5\text{ V}$	—	2.2	—	$\mu\text{A}$
Operating time	$t_{ON}$	$T_a = -25^\circ\text{C}$ to $75^\circ\text{C}$ , $V_{CC} = 3\text{ V}$	10	26	42	$\mu\text{S}$
Stop time	$t_{OFF}$	$T_a = -25^\circ\text{C}$ to $75^\circ\text{C}$ , $V_{CC} = 3\text{ V}$	258	644	1 030	$\mu\text{S}$
Operating time 2	$t_{2ON}$	$T_a = -25^\circ\text{C}$ to $75^\circ\text{C}$ , $V_{CC} = 2.5\text{ V}$	11	27	43	$\mu\text{S}$
Stop time 2	$t_{2OFF}$	$T_a = -25^\circ\text{C}$ to $75^\circ\text{C}$ , $V_{CC} = 2.5\text{ V}$	270	674	1 078	$\mu\text{S}$

Note) It will operate normally in approximately 0.67 ms after power on.

■ Technical Data

- Position of a Hall element (unit in mm)

Distance from a package surface to sensor part: 0.31 mm (reference value)

A Hall element is placed on the shaded part in the figure.

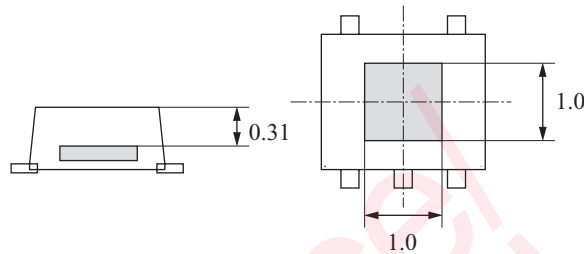

- Magneto-electro conversion characteristics

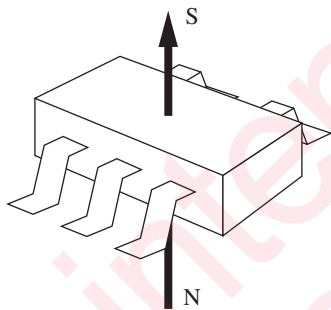

Direction of applied magnetic field

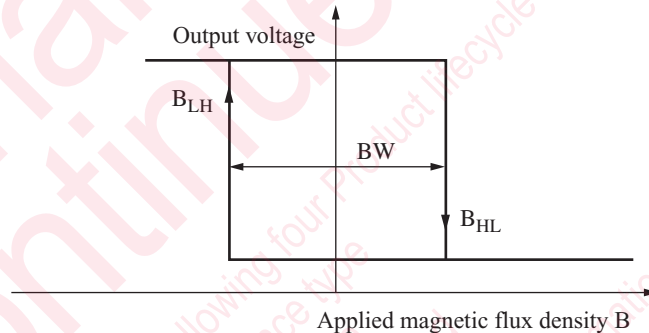

Operating magnetic flux density

- Power dissipation of package SMINI-5DA

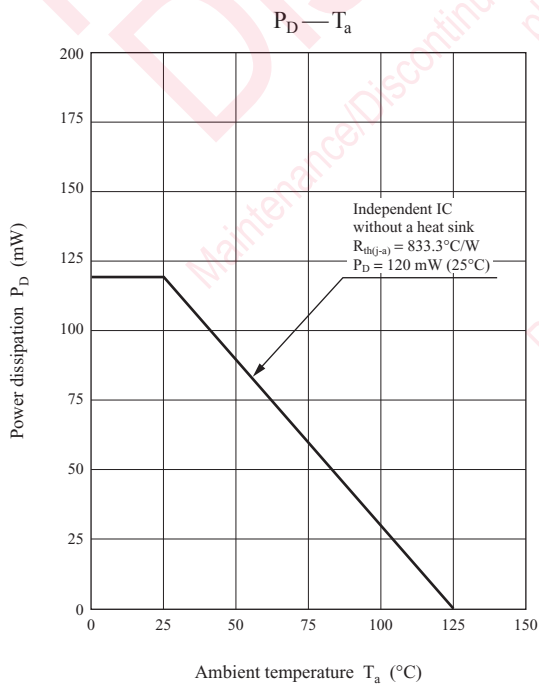

- AN48840B Main characteristics

Operating magnetic flux density — Supply voltage

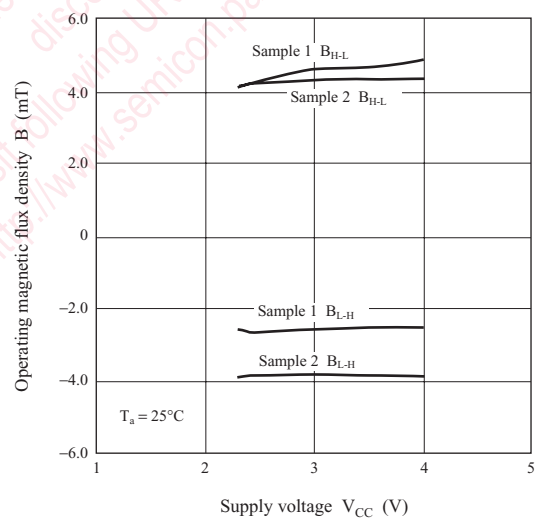

■ Technical Data (continued)

• AN48840B Main characteristics (continued)

Operating magnetic flux density — Ambient temperature

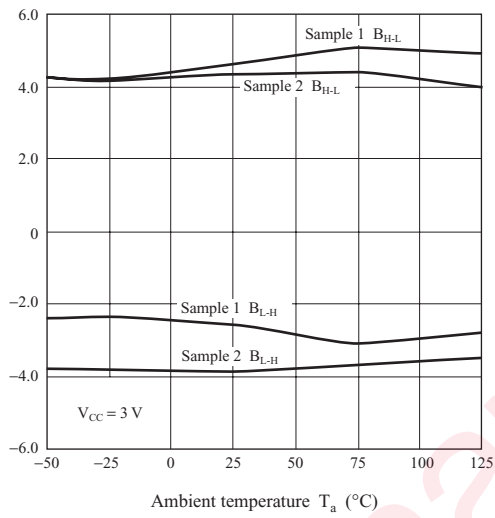

Hysteresis width — Supply voltage

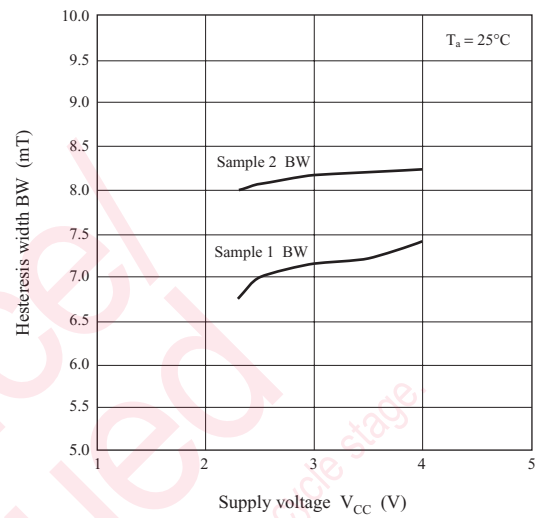

Supply current — Supply voltage

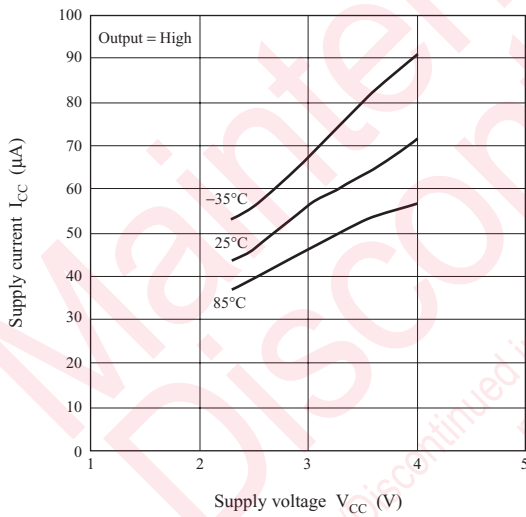

Low-level output voltage — Supply voltage

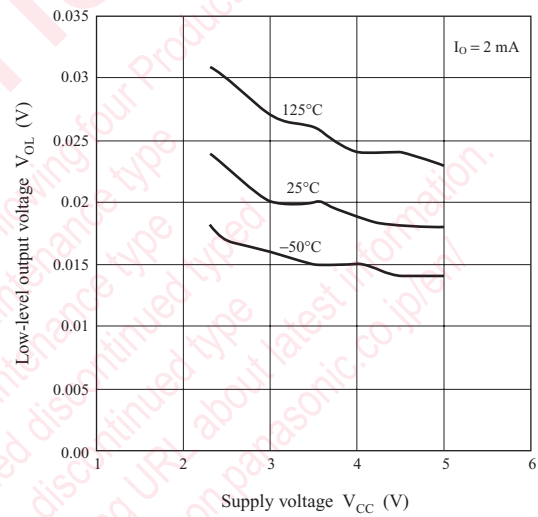

$\Delta$  high-level output voltage — Supply voltage

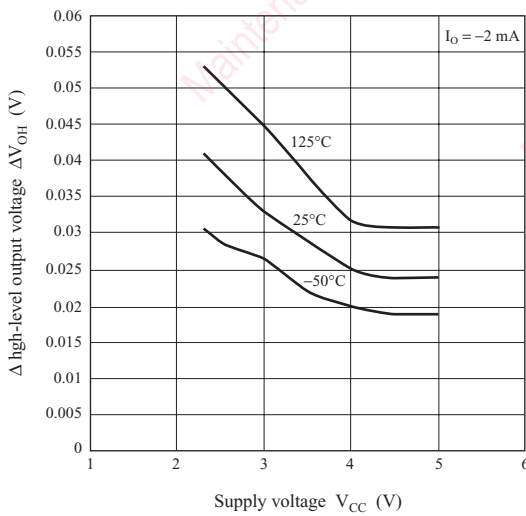

Sampling period — Supply voltage

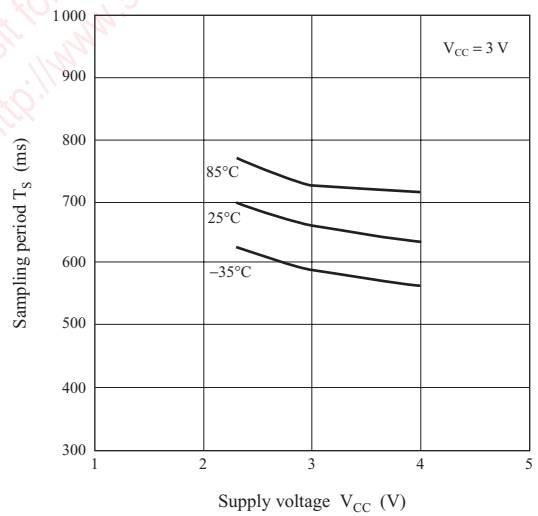

## Request for your special attention and precautions in using the technical information and semiconductors described in this book

- (1) If any of the products or technical information described in this book is to be exported or provided to non-residents, the laws and regulations of the exporting country, especially, those with regard to security export control, must be observed.
- (2) The technical information described in this book is intended only to show the main characteristics and application circuit examples of the products. No license is granted in and to any intellectual property right or other right owned by Panasonic Corporation or any other company. Therefore, no responsibility is assumed by our company as to the infringement upon any such right owned by any other company which may arise as a result of the use of technical information described in this book.
- (3) The products described in this book are intended to be used for standard applications or general electronic equipment (such as office equipment, communications equipment, measuring instruments and household appliances).  
Consult our sales staff in advance for information on the following applications:
  - Special applications (such as for airplanes, aerospace, automobiles, traffic control equipment, combustion equipment, life support systems and safety devices) in which exceptional quality and reliability are required, or if the failure or malfunction of the products may directly jeopardize life or harm the human body.
  - Any applications other than the standard applications intended.
- (4) The products and product specifications described in this book are subject to change without notice for modification and/or improvement. At the final stage of your design, purchasing, or use of the products, therefore, ask for the most up-to-date Product Standards in advance to make sure that the latest specifications satisfy your requirements.
- (5) When designing your equipment, comply with the range of absolute maximum rating and the guaranteed operating conditions (operating power supply voltage and operating environment etc.). Especially, please be careful not to exceed the range of absolute maximum rating on the transient state, such as power-on, power-off and mode-switching. Otherwise, we will not be liable for any defect which may arise later in your equipment.
  - Even when the products are used within the guaranteed values, take into the consideration of incidence of break down and failure mode, possible to occur to semiconductor products. Measures on the systems such as redundant design, arresting the spread of fire or preventing glitch are recommended in order to prevent physical injury, fire, social damages, for example, by using the products.
- (6) Comply with the instructions for use in order to prevent breakdown and characteristics change due to external factors (ESD, EOS, thermal stress and mechanical stress) at the time of handling, mounting or at customer's process. When using products for which damp-proof packing is required, satisfy the conditions, such as shelf life and the elapsed time since first opening the packages.
- (7) This book may be not reprinted or reproduced whether wholly or partially, without the prior written permission of our company.



LittleDiode supplies new, hard to find or obsolete electronic components and semiconductors all over the world.

With over two million different components listed you are sure to find the part you need.

Feel free to visit us today at our online store:

[LittleDiode.com](http://LittleDiode.com)

Looking forward to providing you with the best possible service.