

## PC-BASED DEVELOPMENT SYSTEM CUTS DESIGN TIME OF SMART POWER IC APPLICATIONS

by Thomas L. Hopkins

*A Smart Power Development System allows the designer to evaluate a smart power device in the final application, such as emulator systems allows designers to evaluate and debug micro-processors.*

As smart power integrated circuits become more complex they are approaching the realm where they can be considered power peripheral chips. These new devices can no longer be evaluated with a simple bench set up using a few switches and a function generator. Before the device will operate in an application, one or more registers must be programmed to set the operating conditions of the device. To speed development of applications using these devices a PC based system, the Smart Power Development System, has been developed. The SPDS allows the user to quickly develop and evaluate the device performance in a real application. This paper discusses the SPDS and shows a typical application for a stepper motor drive circuit, the L6223A.

The current generation of smart power integrated circuits contain more logic than their predeces-

sors and many, like the L6280 and L6223A, contain one or more registers that must be programmed for the device to operate. This adds a new dimension to the users task who must now develop software to drive the devices before he can start to evaluate the device operation. In addition such tasks as calculating the power dissipation and required heat sink for a power integrated circuit is a more complicated task than for discrete devices.

To assist the user in evaluating such devices the Smart Power Development System (SPDS) was developed. This PC based system consists of three parts: 1) a general purpose interface card that interfaces to the PC bus, 2) a dedicated printed circuit board for each device supported, and 3) a dedicated software package for each device supported. The block diagram of the SPDS is shown in figure 1.

**Figure 1:** PC-Based SPDS

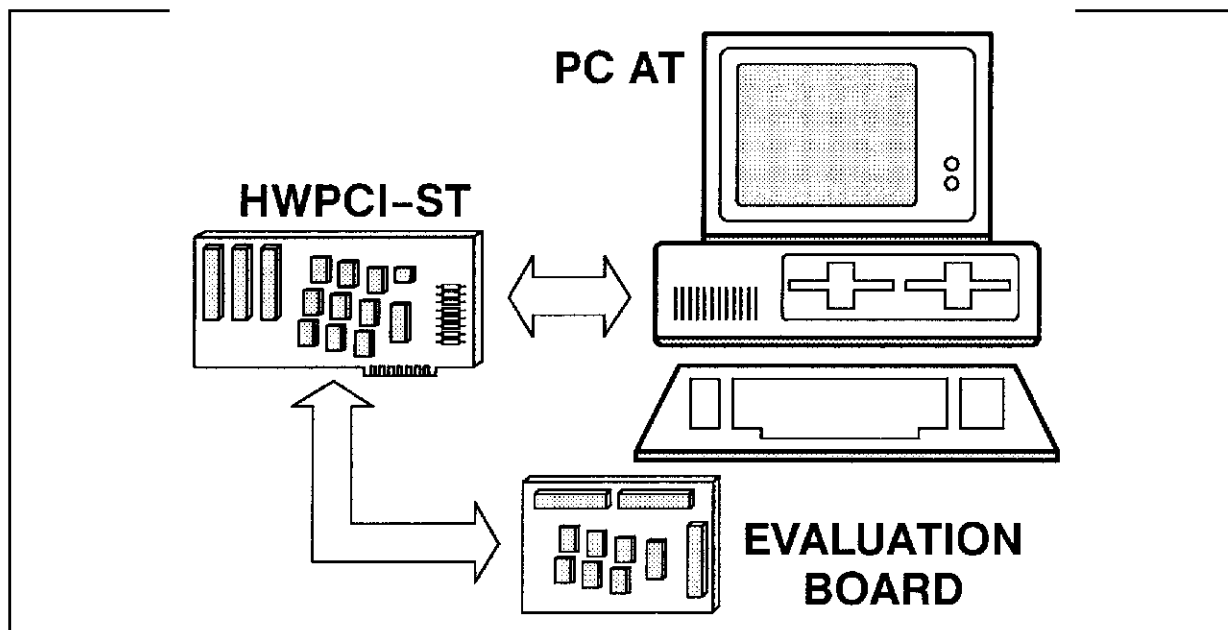

## APPLICATION NOTE

### PC INTERFACE

To allow the PC to easily drive a variety of applications, a general purpose interface card was needed. The interface card chosen, similar to the Burr-Brown PCI 2000 Series, provides 32 I/O lines, 4 counter/timer channels, and a rate generator, as shown in figure 2.

The 32 I/O lines are general purpose parallel lines that may be programmed, in groups of 8, as either output or input lines. The 32 I/O lines plus their associated control registers are mapped, as eight bit registers, into the user address space of the PC and are easily addressed by the application program. In the SPDS system these 32 lines are used as parallel outputs to drive the dedicated application board.

The rate generator provides a stable timebase for

operation of the system. The frequency of the rate generator output is given by the equation:

$$F_{out} = \frac{8MHz}{(N_1 \cdot N_2)}$$

where  $N_1$  and  $N_2$  are integers between 2 and 65535. In this configuration, the output frequency can then range from 2 MHz to approximately .002 Hz. This clock signal is used by the four counter timer channels that provide the variable step rate timing used in stepper motor applications or the period of output patterns in pattern generator type applications.

This flexible configuration allows the PC interface to be independent of the device being evaluated and provides a general purpose interface that can drive many types of applications.

**Figure 2:** SPDS Interface Card

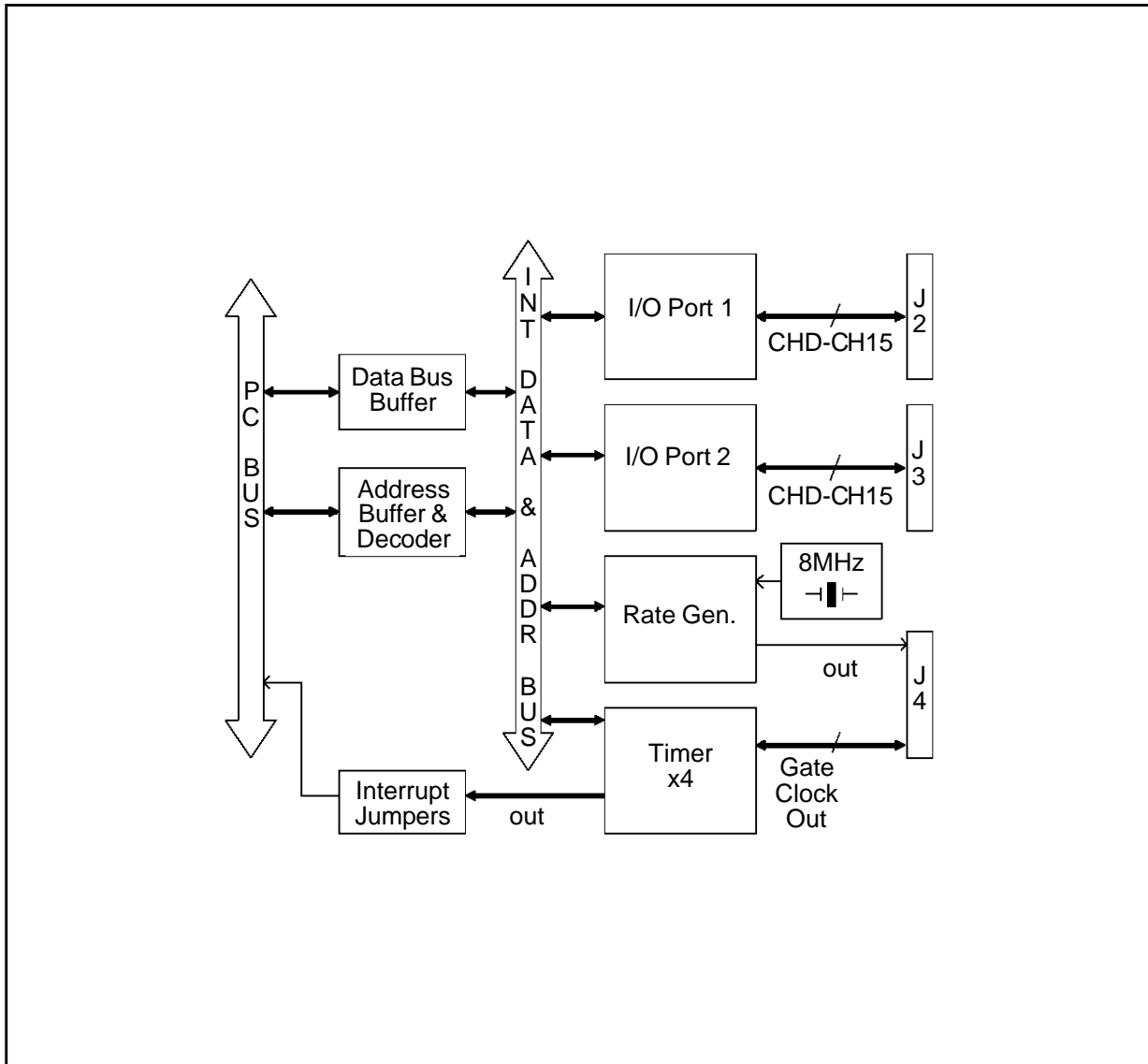

**DEDICATED HARDWARE**

Each device, or family of devices, supported by the SPDS has a dedicated application board that connects to the PC interface card and includes the dedicated circuitry around the evaluation de-

vice. In the case of the L6223A the dedicated board includes two configurations for the L6223A driving a unipolar stepper motor, a single device application and a dual device application. The schematic diagram for the L6223A Dedicated Board is shown in Figure 3.

**Figure 3:** Dedicated Board for L6223A

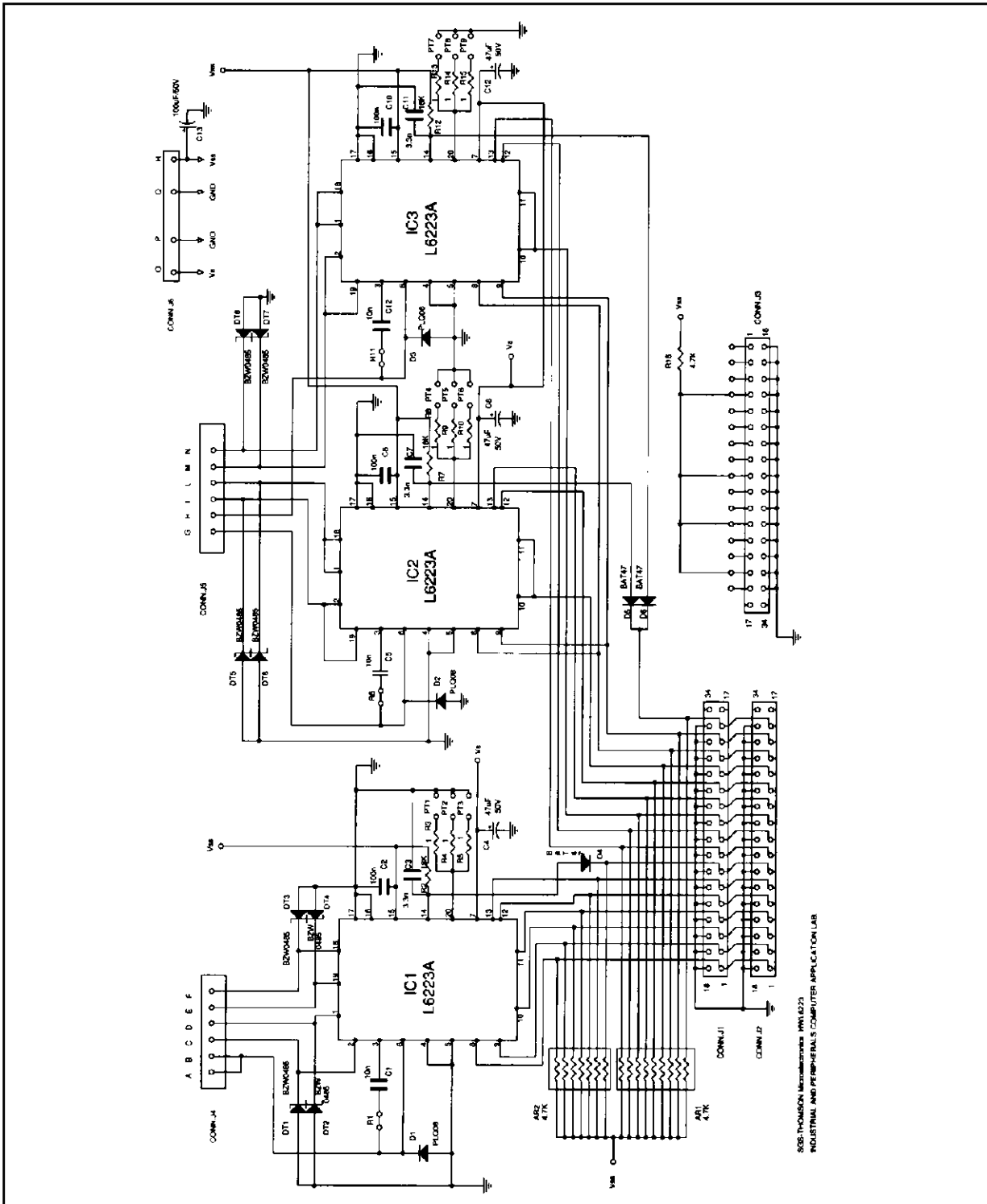

SGS-THOMSON MICROELECTRONICS WWW.L6223  
INDUSTRIAL AND PERIPHERALS COMPUTER APPLICATION LAB

## APPLICATION NOTE

This allows the user to choose the configuration that best suits his application depending on the current level required by the motor.[2] The software then allows the user to select which of the two implementations will be driven for evaluation.

Other dedicated boards support devices in bipolar stepper motor driver applications, DC motor driver applications, and solenoid driver applications.

### SOFTWARE

Each of the SPDS systems includes a software package dedicated specifically to the devices. Although the features vary depending on the application and the specific devices, the L6223A package is typical. The L6223A package includes: 1) calculation of the acceleration and deceleration ramps for a stepper motor, 2) a driver routine for real time operation and 3) a simulation package that simulates the thermal behavior of the device or devices.

### ACCELERATION AND DECELERATION RAMPS

The acceleration/deceleration ramp section the program is unique to step motor applications. This

routine calculates the step timing required to raise the step motor from zero up to the final speed. The calculation is made from the mechanical characteristics of the application.

The required inputs include the characteristics of the motor, specifically the static Torque ( $T_{stat}$ ), the slope of the Torque vs Speed curve ( $T_{slope}$ ) and the number of steps per revolution. The torque characteristics for a typical stepper motor are shown in Figure 4. In the simple model for a stepper motor the torque decreases approximately linearly as the speed increases from zero up to the maximum motor speed where the Torque falls to zero.[1] This curve can be approximated by a straight line having a static Torque ( $T_{stat}$ ) and a slope ( $T_{slope}$ ) as shown in Figure 4. Here the approximation for the torque curve allows for a Torque utilization factor of less than unity.[1] In addition to the motor characteristics the program needs the mechanical characteristics of the system, as referred to the motor shaft. The two required values are the frictional Torque ( $T_{fric}$ ) and the total Inertia ( $J_{tot}$ ). From these values the program calculates the period of each step during the acceleration ramp. These values are then saved and used by the real time program to drive the motor.

**Figure 4:** Typical stepper motor torque characteristics

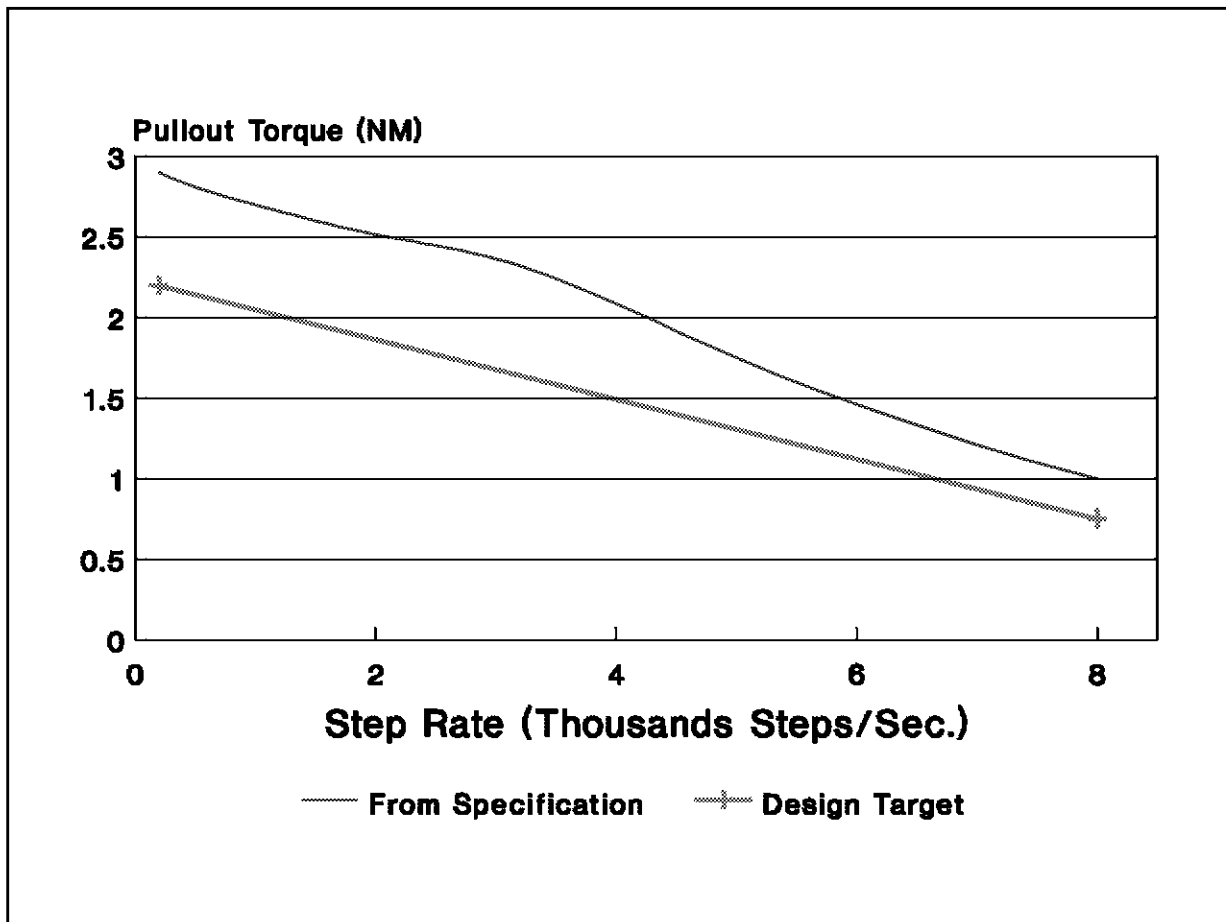
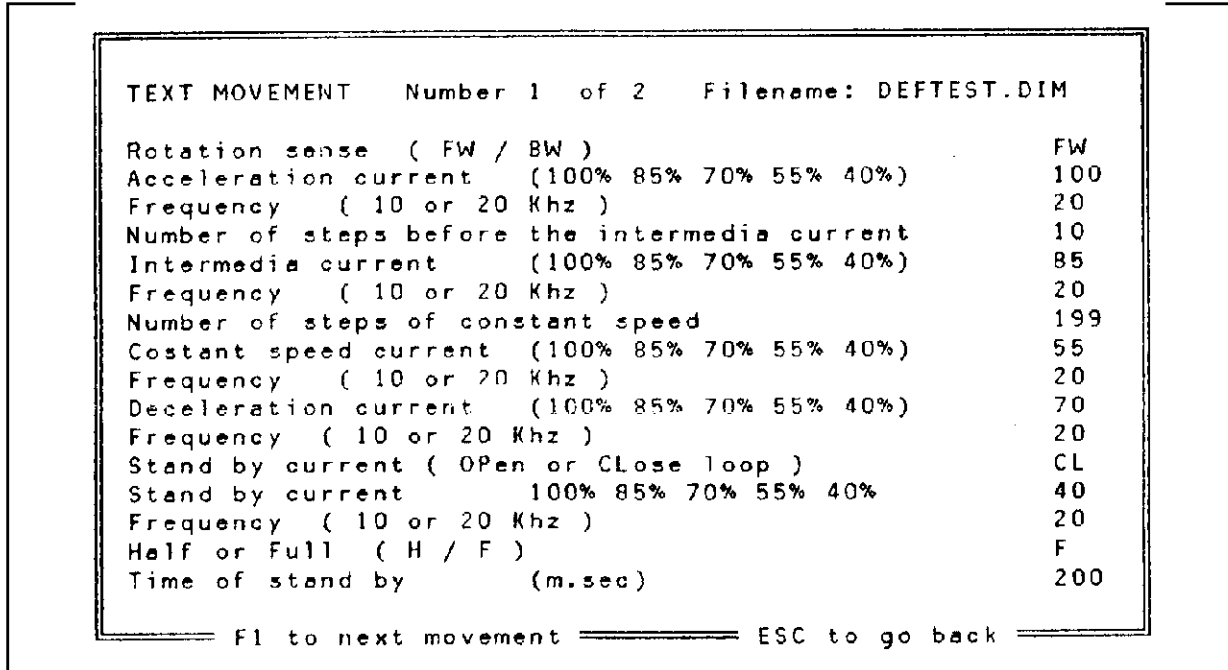

Figure 5: SPDS entry screen



REAL TIME OPERATION

One major advantage of the SPDS is the ability to operate the devices in a real time application without having to first write a driver routine. In the real time operation section of the program the user defines a sequence of movements and the motion profile and operating parameters for each movement. This is done using a simple text entry screen, as shown in Figure 5. Each movement is

divided into five segments, as shown in Figure 6. Using the motion text entry screen, the user may define the operating conditions of the driver chip for each segment of the movement. The entry screen allows the user to select one of five current levels and the chopping frequency, both of which are selected by programming the internal shift register in the L6223A [3], for each segment of the movement.

Figure 6: Stepper movements

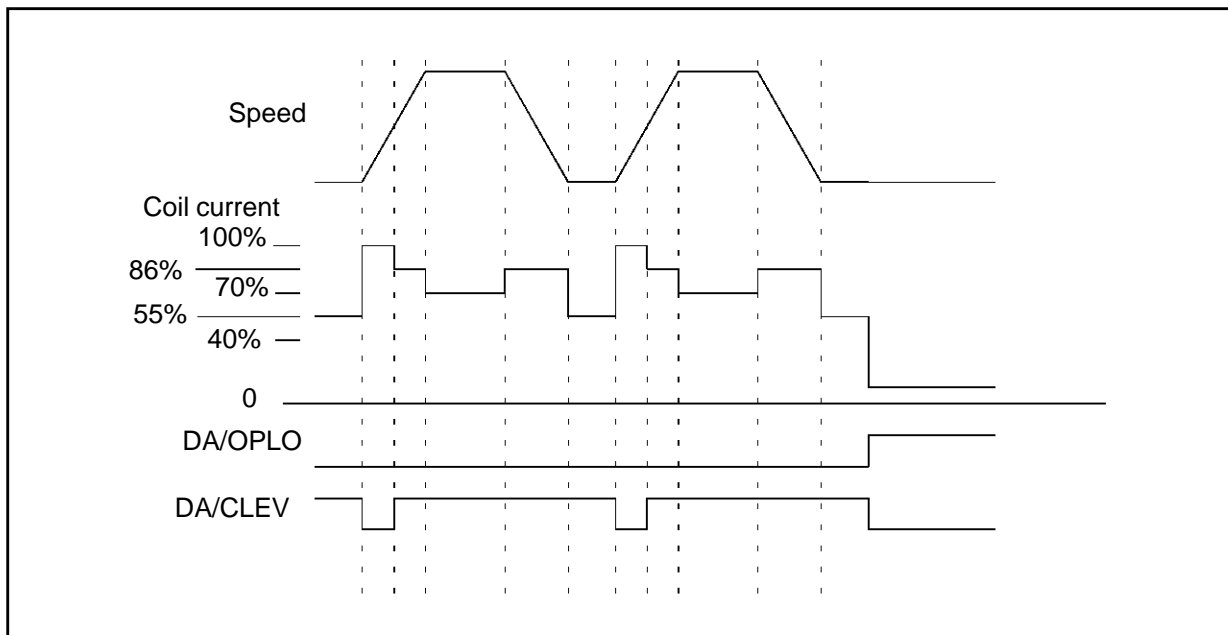

## APPLICATION NOTE

The entry screen also allows the user to define the number of steps in the first segment and the third segment of the movement. The number of steps in the second and fourth segment of the movement are defined by the acceleration ramp and deceleration ramps being used.

The final segment of the movement is the standby period, which is really the period where there is no movement between two movements. The user is allowed to select the period and operating conditions during standby. Utilizing the programmability of the L6223A, the user may select either open loop or closed loop operation during this time as well as the current level and the chopping frequency.

The user may define any number of movements in a sequence and then set the parameters of each movement. Once this definition is completed, the SPDS will continually execute the sequence programmed in real time. In the execute mode the SPDS displays some of the operating parameters of the system, as shown in Figure 7 and 11. During the execution the user may modify the step timing of either the acceleration or deceleration ramps and observe the affect on the mechanical behavior of the system.

Once the user is satisfied with the system operation all of the values of the acceleration ramp, deceleration ramp and motion profile can be saved on the disk for future use.

### SAFE (and SAVE) DESIGN BY SIMULATION

The final section of the SPDS system allows the user to evaluate the thermal behavior of the device in the application. In this section the movement is simulated based on the average velocity, as shown in Figure 8. Using the input electrical parameters of the application and motor, the program calculates the chopping duty cycle and the effect on power dissipation due to the step rate. To these values are added the quiescent losses, which are assumed to be constant, to get find the power dissipation in the device. The program also accounts for variation in the  $R_{DSon}$  with die temperature.

The simulation outputs two representations of the information. The first, shown in Figure 9, shows the power dissipation and required thermal impedance from the junction to ambient ( $R_{thj-a}$ ) to limit the maximum junction temperature to a specified value versus the peak coil current ( $I_p$ ).

Figure 7: Operating parameter display

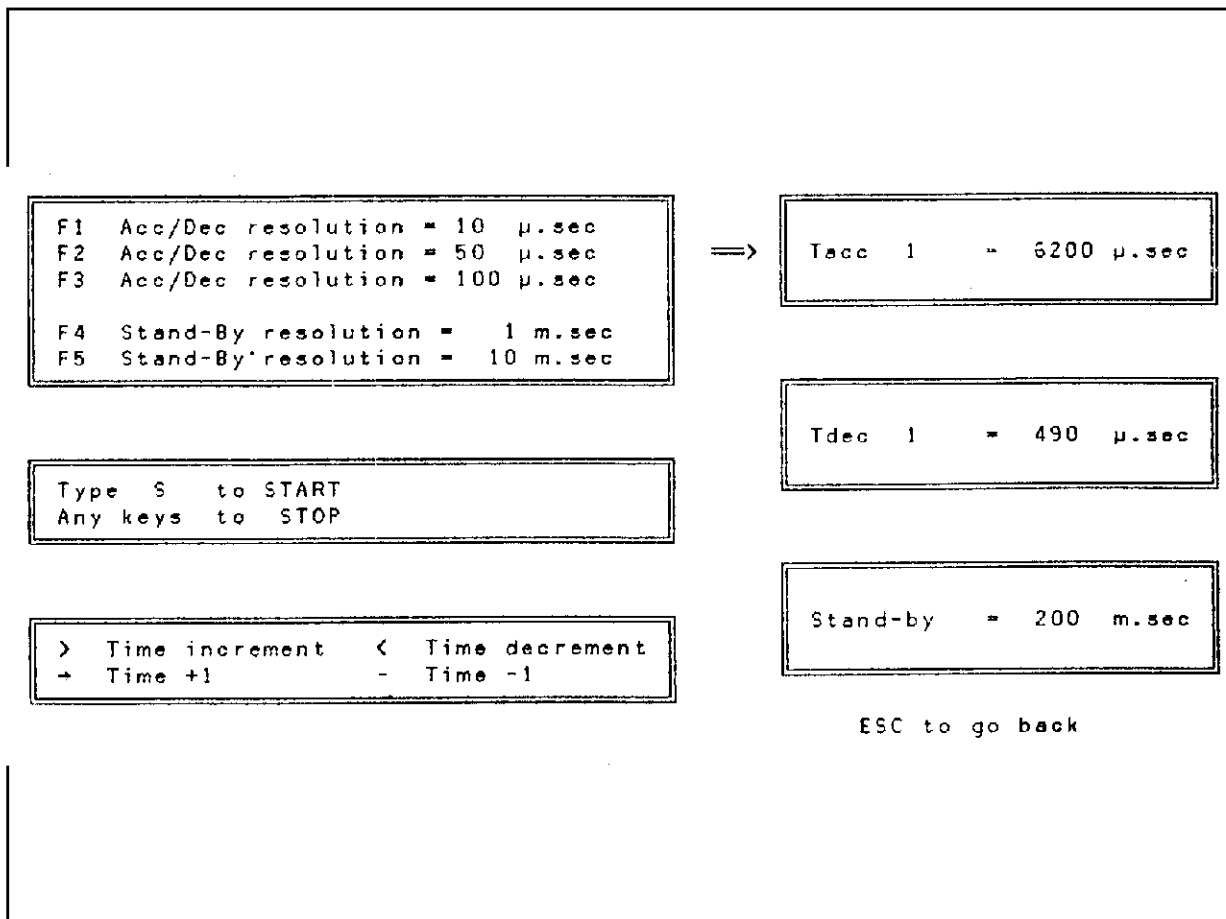

Figure 8: Stepper motor movement simulation

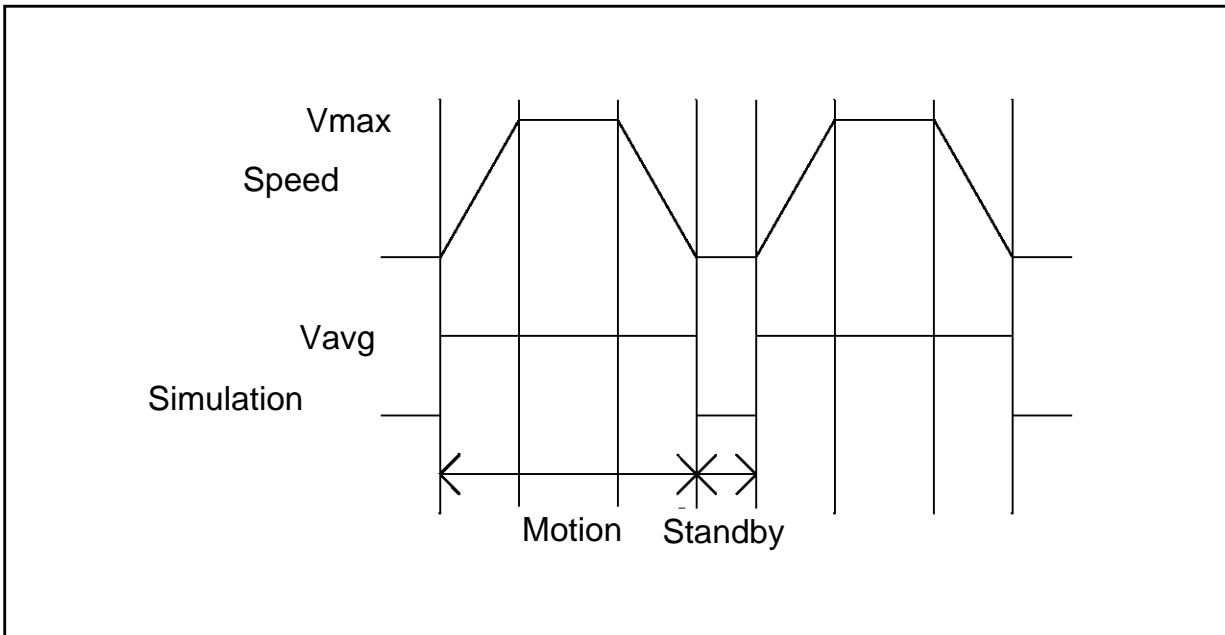
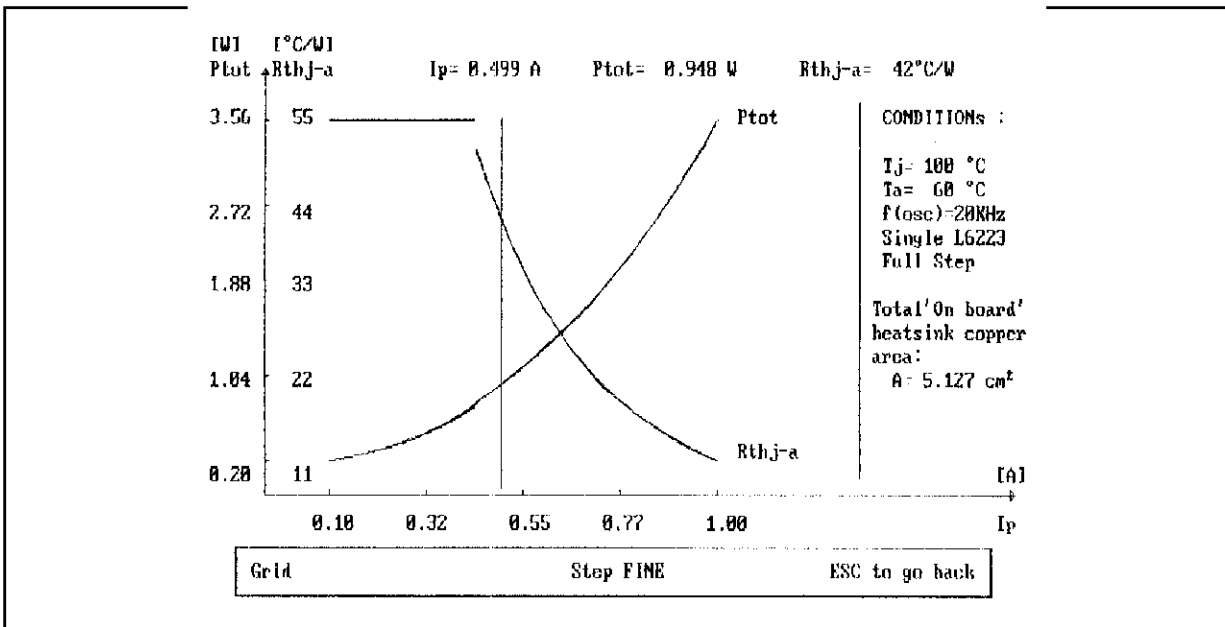

Figure 9: Power dissipation and required thermal impedance



For required values of thermal impedance less than 55°C/W (the thermal impedance of the package in free air) the power dissipation is calculated assuming a constant thermal impedance of 55°C/W. For any given value of current, selected by moving the cursor, the calculated value for  $P_d$  and  $R_{thj-a}$  are shown on the top of the graph. The program also calculates the number of square inches of copper required on the printed circuit board to achieve the required thermal impedance,

for values that are achievable in this manner. When the power dissipation exceeds the level that may be dissipated in this configuration, a message that an external heat sink is required is displayed.

The second output (see fig. 10) of the simulation program calculates the power dissipation and die temperature assuming constant values of  $R_{thj-a}$ . For this simulation, three values of thermal impedance are chosen; the thermal impedance of

## APPLICATION NOTE

Figure 10: Power dissipation and die temperature

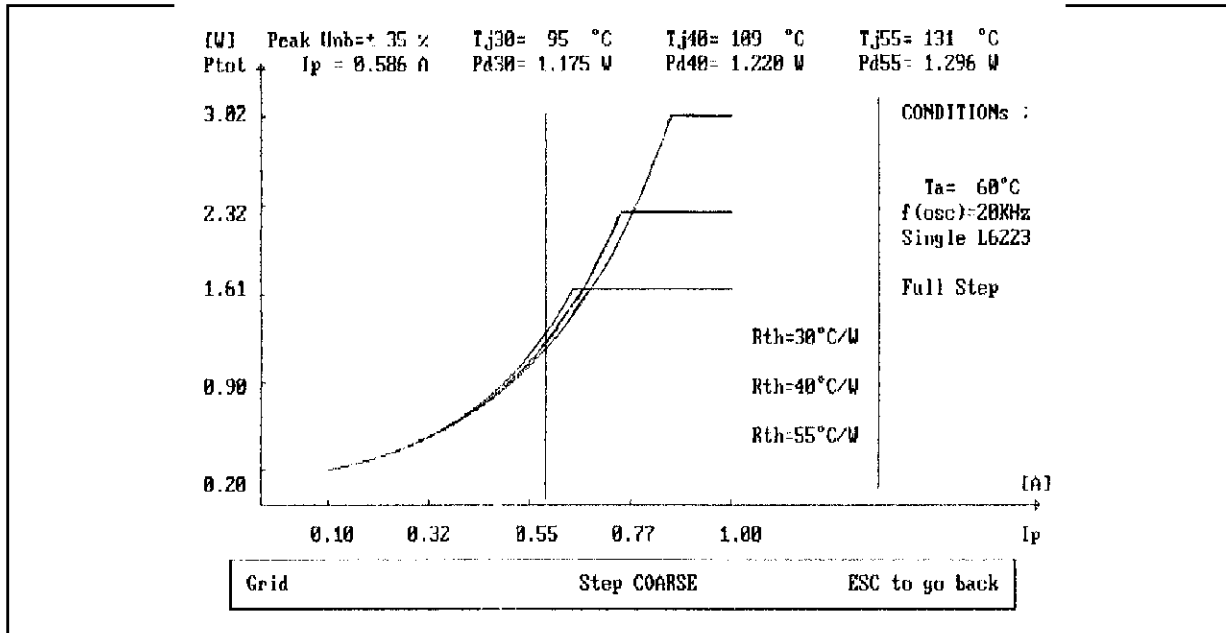
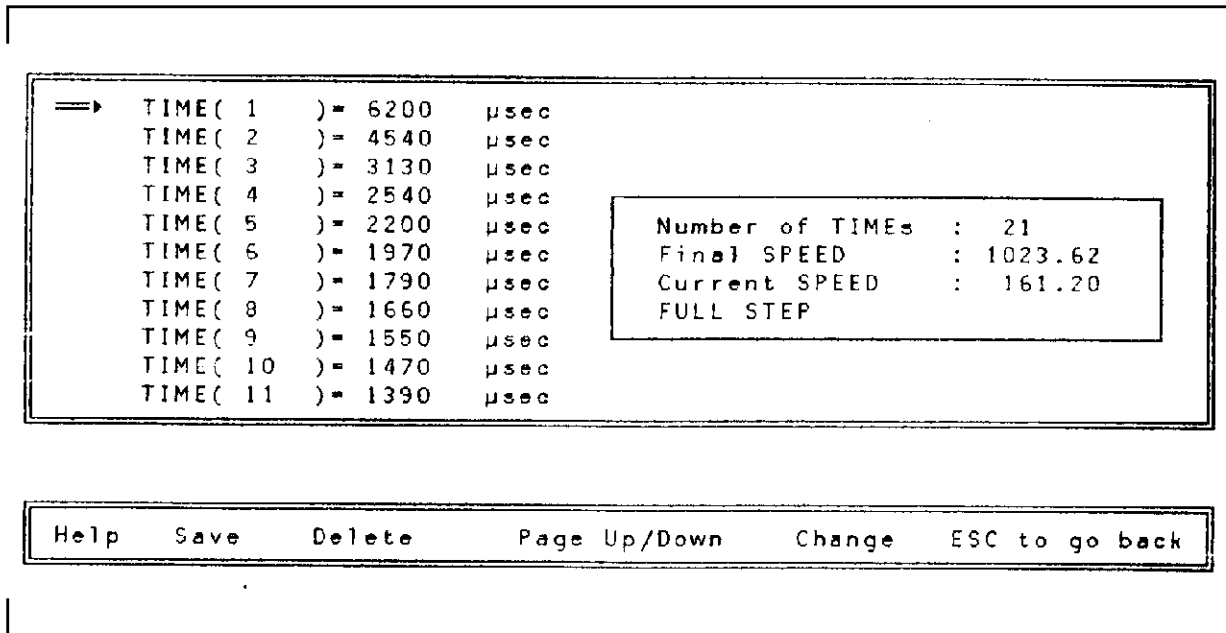

Figure 11: Acceleration ramp timing



the package in free air (55°C/W), the minimum practical value of thermal impedance using only copper on the PCB (40°C/W) and the minimum practical value using an external clip on heat sink (30°C/W).[4] Each of the graphs are interrupted when the die temperature exceeds 150°C, the maximum rating of the device. When the current level selected by the cursor would cause the device to exceed the maximum rating, a message is displayed that the device will go into thermal shut down at that level.

## CONCLUSION

The Smart Power Development System allows the user to quickly evaluate a smart power device in the final application, much as emulator systems allow user to evaluate and debug microprocessors. The system contains two key components that allow the user to 1) quickly define the operation of the device and evaluate it in a real time application and 2) verify that the device will operate within its safe operating limits. For compli-

cated devices that require the user to program one or more internal registers before the device will operate, the system can greatly reduce the time required to evaluate the system, without requiring the user to write any specific software.

### REFERENCES

- 1) A. Leenouts, The Art and Practice of Step Motor Control, Intertec Communications Inc., Ventura Ca., 1987
- 2) T. Hopkins, "A Single Chip Driver for Unipolar Stepper Motors", Proceedings of Motor-Con '89 (PCIM 89), Long Beach Ca, October 1989, pp 437-445
- 3) "L6223A Data Sheet", Industrial and Computer Peripheral ICs databook 2nd Edition, 1992, pp 449 to 479.
- 4) T. Hopkins, "Designing with Thermal Impedance" Proceedings of the Fourth Annual IEEE Semiconductor Thermal and Temperature Measurement Symposium, San Diego, Ca., Feb. 1988.

## APPLICATION NOTE

---

Information furnished is believed to be accurate and reliable. However, SGS-THOMSON Microelectronics assumes no responsibility for the consequences of use of such information nor for any infringement of patents or other rights of third parties which may result from its use. No license is granted by implication or otherwise under any patent or patent rights of SGS-THOMSON Microelectronics. Specifications mentioned in this publication are subject to change without notice. This publication supersedes and replaces all information previously supplied. SGS-THOMSON Microelectronics products are not authorized for use as critical components in life support devices or systems without express written approval of SGS-THOMSON Microelectronics.

© 1995 SGS-THOMSON Microelectronics - All Rights Reserved

SGS-THOMSON Microelectronics GROUP OF COMPANIES

Australia - Brazil - France - Germany - Hong Kong - Italy - Japan - Korea - Malaysia - Malta - Morocco - The Netherlands - Singapore - Spain - Sweden - Switzerland - Taiwan - Thailand - United Kingdom - U.S.A.



LittleDiode supplies new, hard to find or obsolete electronic components and semiconductors all over the world.

With over two million different components listed you are sure to find the part you need.

Feel free to visit us today at our online store:

[LittleDiode.com](http://LittleDiode.com)

Looking forward to providing you with the best possible service.