

AN3986FBP, AN3986FHP

Stereo Audio Signal Processor ICs for 8-mm Camcorder

■ Overview

The AN3986FBP and the AN3986FHP are stereo audio signal processor ICs for 8-mm camcorder. It incorporates all the functions needed for stereo-audio signal processing in 8mm camcorder.

■ Features

- Built-in headphone amplifiers
- Built-in matrix signal processing

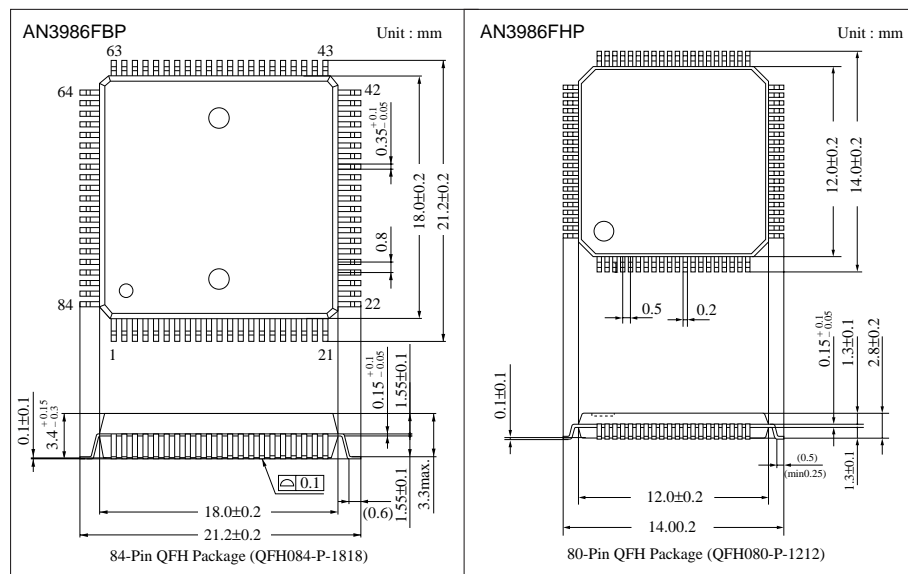

■ Absolute Maximum Ratings

AN3986FBP

Parameter	Symbol	Rating	Unit
Supply voltage	V_{CC}	$V_{CC1}=6 / V_{CC2}=9.5$	V
Power dissipation ^{Note 2)}	P_D	474	mW
Operating ambient temperature ^{Note 1)}	T_{opr}	-20 to +70	°C
Storage temperature ^{Note 1)}	T_{stg}	-55 to +125	°C

AN3986FHP

Parameter	Symbol	Rating	Unit
Supply voltage	V_{CC}	$V_{CC1}=6 / V_{CC2}=9.5$	V
Power dissipation ^{Note 2)}	P_D	392	mW
Operating ambient temperature ^{Note 1)}	T_{opr}	-20 to +70	°C
Storage temperature ^{Note 1)}	T_{stg}	-55 to +125	°C

Note 1) $T_a=25^{\circ}\text{C}$ except operating ambient temperature and storage temperature unless otherwise specified.
 Note 2) Allowable power dissipation of the package at $T_a=70^{\circ}\text{C}$.

■ Block Diagram

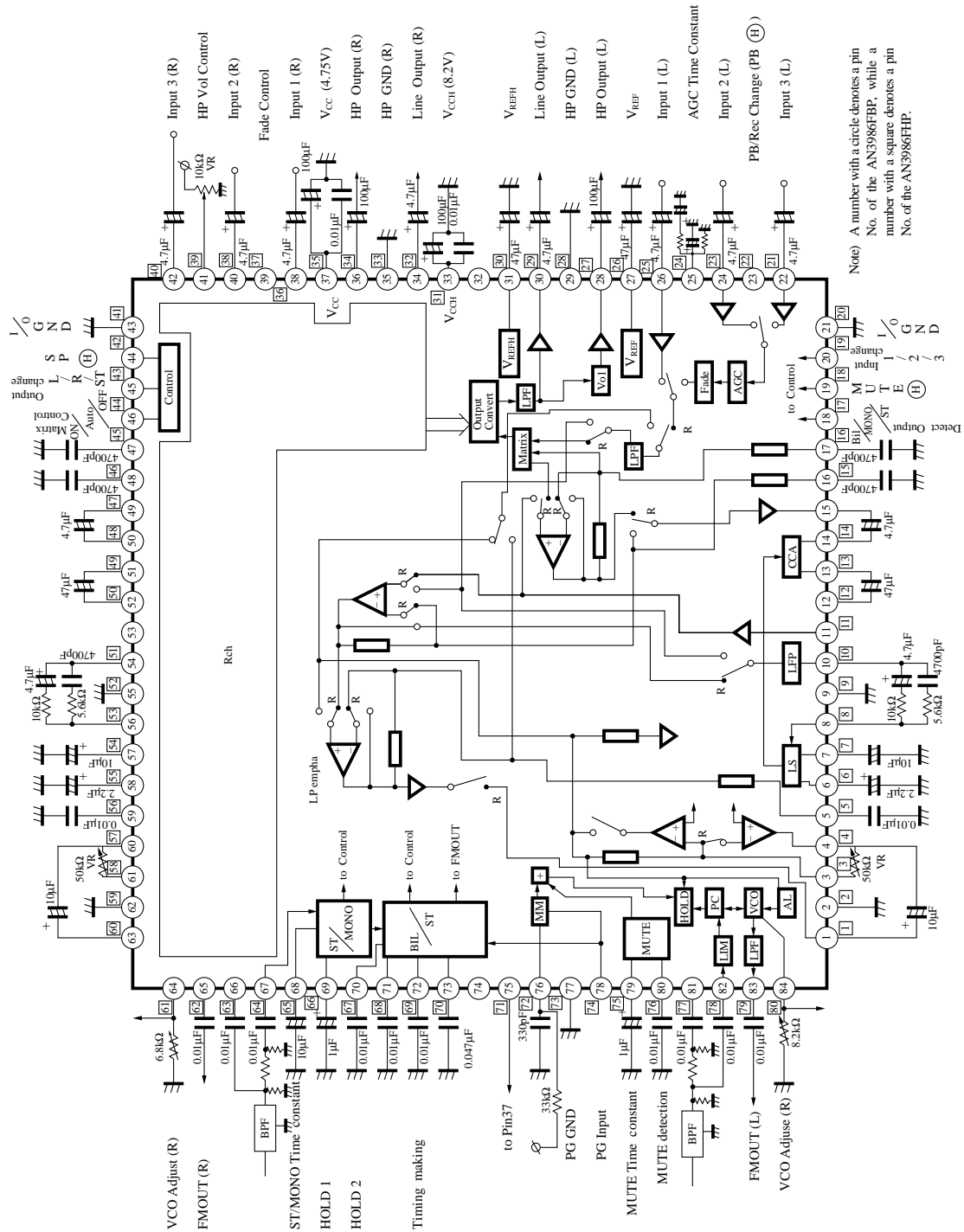

■ Recommended Operating Range (Ta=25°C)

Parameter	Symbol	Range
Operating supply voltage range	V _{CC1}	4.5V to 5.5V
	V _{CC2}	4.5V to 9.0V

■ Pin Descriptions

Pin No.		Pin name	Pin No.		Pin name
AN3986FHP	AN3986FBP		AN3986FHP	AN3986FBP	
1	1	NR input/output (L)	41	43	GND
2	2	GND	42	44	SP/EP mode switching
3	3	Dev. adjustment 1 (L)	43	45	Output switching control
4	4	Dev. adjustment 2 (L)	44	46	Matrix control
5	5	LP emphasis (L)	45	47	NR emphasis (R)
6	6	Level sensor timing C1 (L)	46	48	FM emphasis (R)
7	7	Level sensor timing C2 (L)	47	49	Buffer input (R)
8	8	Level sensor input (L)	48	50	CCA input (R)
9	9	GND	49	51	CCA output (R)
10	10	LPF output (L)	50	52	CCA amp. input (R)
11	12	CCA amp. input (L)	51	54	LPF output (R)
12	13	CCA output (L)	52	55	GND
13	14	CCA input (L)	53	56	Level sensor input (R)
14	15	Buffer output (L)	54	57	Level sensor timing C2 (R)
15	16	FM emphasis (L)	55	58	Level sensor timing C1 (R)
16	17	NR emphasis (L)	56	59	LP emphasis (R)
17	18	Mode discriminator output	57	60	Dev. adjustment 2 (R)
18	19	Mute control	58	61	Dev. adjustment 1 (R)
19	20	Input change switch	59	62	GND
20	21	GND	60	63	NR input/output (R)
21	22	Input 3 (L)	61	64	VCO frequency adjustment (R)
22	23	Rec/PB switching (L)	62	65	FM modulator output (R)
23	24	Input 2 (L)	63	66	FM demodulator input (R)
24	25	AGC time-constant	64	67	FM detector input (R)
25	26	Input 1 (L)	65	68	FM input AGC detection
26	27	V _{REF}	66	69	ST/MON time-constant
27	28	Headphone output (L)	67	70	HOLD 2
28	29	Headphone GND (L)	68	71	HOLD 1
29	30	Line output (L)	69	72	ST/MON detection
30	31	V _{REF} H	70	73	Bilingual timing generation
31	33	V _{CC2}	71	75	V _{CC1} (FM)
32	34	Line output (R)	72	76	Mono/multi time-constant
33	35	Headphone GND (R)	73	77	GND (PG)
34	36	Headphone output (R)	74	78	PG input
35	37	V _{CC1}	75	79	MUTE time-constant
36	38	Input 1 (R)	76	80	MUTE detection
37	39	Fade control	77	81	FM detection input (L)
38	40	Input 2 (R)	78	82	FM demodulator input (L)
39	41	Headphone volume control	79	83	FM modulator output (L)
40	42	Input 3 (R)	80	84	VCO frequency adjustment (L)

Note) Pins 11, 32, 53, and 74 of the AN3986FBP are to be left open.

■ Electrical Characteristics (cont.) ($V_{CC1}=4.75V$, $V_{CC2}=8.2V$, $T_a=25\pm 2^{\circ}C$) (AN3986FHP)

Parameter	Symbol	Condition	min	typ	max	Unit
Circuit current 1 at recording	I_{R35}	$V_{CC1}=4.75V$, when no signal input	58	73	88	mA
Circuit current 2 at recording	I_{R31}	$V_{CC2}=8.20V$, when no signal input	1.6	2.0	2.4	mA
Circuit current 1 at playing back	I_{P35}	$V_{CC1}=4.75V$, when no signal input	61	77	93	mA
Circuit current 1 at playing back	I_{R31}	$V_{CC2}=8.20V$, when no signal input	1.6	2.0	2.4	mA
Line AGC output level Lch, Rch	V_{OALL} V_{OALR}	$V_{IN}=20dBs$ $f=400Hz$	-8	-7	-6	dBs
Line AGC output distortion factor Lch, Rch	T_{HALL1} T_{HALR1}	$V_{IN}=20dBs$ $f=1kHz$, THD 5th	—	0.02	0.1	%
AGC ON output level Lch, Rch	V_{OALL2} V_{OALR2}	$V_{IN}=-2dBs$ $f=400Hz$	-4	-1	+2	dBs
AGC ON output distortion factor Lch, Rch	T_{HALL2} T_{HALR2}	$V_{IN}=-2dBs$ $f=1kHz$, THD 5th	—	0.2	0.4	%
Line AGC output noise Lch, Rch	V_{NALL} V_{NALR}	No input A curve filter	—	-78	-74	dBs
Fade control maximum attenuation output Lch, Rch	V_{FALL} V_{FALR}	$V_{IN}=-20dBs$, 1kHz A curve filter	—	-80	-75	dBs
Line through monitor output level Lch, Rch	V_{OILL} V_{OILR}	$V_{IN}=-20dBs$, 400Hz	-8	-7	-6	dBs
Line through monitor output noise Lch, Rch	V_{NLLL} V_{NLLR}	No input A curve filter	—	-81	-77	dBs
Between inputs between channels crosstalk	V_{CTIN}	$V_{IN}=-14dBs$, 1kHz A curve filter	—	-78	-74	dB
E-E monitor output frequency characteristics Lch, Rch	V_{OLFL} V_{OLFR}	$V_{IN}=-20dBs$ ratio of 40kHz/40Hz	—	-5.5	-2.5	dBs
HP output level $V_{OL}=\text{CENTER}$ Lch, Rch	V_{HC8L} V_{HC8R}	$V_{IN}=-20dBs$, 400Hz 8 Ω load	-28	-26	-24	dBs
HP output distortion factor $V_{OL}=\text{CENTER}$ Lch, Rch	T_{HHC8L} T_{HHC8R}	$V_{IN}=-20dBs$, 1kHz 8 Ω load, THD 5th	—	0.05	0.5	%
HP output level $V_{OL}=\text{MAX}$ Lch, Rch	V_{HH8L} V_{HH8R}	$V_{IN}=-20dBs$, 400Hz 8 Ω load	-18	-16	-14	dBs
HP output level $V_{OL}=\text{MIN}$ Lch, Rch	V_{HL8L} V_{HL8R}	$V_{IN}=-20dBs$, 400Hz 8 Ω load	—	-96	-92	dBs
HP output noise voltage $V_{OL}=\text{MIN}$ Lch, Rch	V_{NHCOL} V_{NHCOR}	No input A curve filter	—	-96	-92	dBs
HP maximum output level $V_{OL}=\text{CENTER}$ Lch, Rch	V_{MH8L} V_{MH8R}	1kHz, at 1% distortion, 8 Ω load THD 5th	-18	—	—	dBs
Encode output level Lch, Rch	V_{ORLL} V_{ORLR}	$V_{IN}=-20dBs$, 400Hz BIL mode	-18	-15	-12	dBs
Encode output distortion factor Lch, Rch	T_{HORLL} T_{HORLR}	$V_{IN}=-20dBs$, 1kHz to THD 5th	—	0.2	0.4	%
Encode linearity Lch, Rch	V_{OXLL} V_{OXLR}	$V_{IN}=-11.2/-51.2BS$ $f=400Hz$	-21	-20	-19	dB
SP encode f characteristics Lch, Rch	V_{FORLL} V_{FORLR}	$V_{IN}=-20dBs$ $f=10kHz/400Hz$	3.8	4.8	5.8	dB
LP encode f characteristics Lch, Rch	V_{FLRLL} V_{FLRLR}	$V_{IN}=-20dBs$, 10kHz ratio of LP/SP	2.0	3.0	4.0	dB
Encode output noise Lch, Rch	V_{NRLL} V_{NRRR}	No input A curve filter	—	-55	-51	dB
ST/BIL level difference L + R Lch	V_{BSRLL}	$V_{IN}=-20dBs$, 400Hz	-0.5	0	+0.5	dB
ST/BIL level difference L - R Lch	V_{BSRLR}	$V_{IN}=-20dBs$, 400Hz 30kHz LPF	—	-30	-17.5	dB
MON/BIL level difference Lch	V_{BMRLL}	$V_{IN}=-20dBs$, 400Hz	-0.5	0	+0.5	dB
Decode reference output level Lch, Rch	V_{OLPL} V_{OLPR}	V_{OLL} , input V_{ORLR}	-9.5	-7	-4.5	dB

■ Electrical Characteristics (cont.) ($V_{CC1}=4.75V$, $V_{CC2}=8.2V$, $T_a=25\pm 2^\circ C$) (AN3986FHP)

Parameter	Symbol	Condition	min	typ	max	Unit
Decode reference output distortion factor Lch, Rch	T_{HOLPL} T_{HOLPR}	V_{ORLL} , input V_{ORLR}	—	0.12	0.3	%
Decode linearity Lch, Rch	V_{OXPL} V_{OXPR}	$V_{IN}=-11.6/-41.6dBs$ $f=400Hz$	-63	-60	-57	dB
Decode output noise Lch, Rch	V_{NLPL} V_{NLPR}	No input A curve filter	—	-87	-79	dBs
Crosstalk Lch, Rch, at playback	C_{ERL} C_{ERR}	$V_{IN}=-20dBs$, 1kHz A curve filter	—	—	-79	dBs
Maximum output level Lch, Rch, at playback	V_{OLML} V_{OLMR}	$V_{IN}=-10dBs$, 1kHz THD 5th	—	0.4	1.0	%
Line mute attenuation quantity Lch, Rch	V_{MLML} V_{MLMR}	$V_{IN}=-20dBs$, 1kHz A curve filter	—	-92	-87	dBs
Encode channel crosstalk Lch, Rch	S_{ERL} S_{ERR}	$V_{IN}=-14dBs$, 1kHz A curve filter	—	-50	-47	dBs
E-E system monitor output channel balance	B_{AL}	V_{OALR}/V_{OALL}	-0.55	0	+0.55	dB
Encode output channel balance	B_{RE}	V_{ORLR}/V_{ORLL}	-2	0	+2	dB
Decode output channel balance	B_{LP}	V_{OLPR}/V_{OLPL}	-3	0	+3	dB
VCO free-run frequency Lch	F_{OL}	$R=8.2k\Omega$	1.35	1.50	1.65	MHz
VCO free-run frequency Rch	F_{OR}	$R=6.8k\Omega$	1.55	1.70	1.85	kHz
VCO output amplitude voltage Lch	V_{79}	when $f=1.5MHz$	456	500	548	mV _{P-P}
VCO output amplitude voltage Rch	V_{62}	when $f=1.7MHz$	410	450	493	mV _{P-P}
VCO 2nd harmonics output Lch	V_{79-2}	fundamental wave as 0dB	—	-50	-35	dB
VCO 2nd harmonics output Rch	V_{62-2}	fundamental wave as 0dB	—	-50	-35	dB
VCO reference frequency deviation Lch	V_{79-3}	fundamental wave as 0dB	—	-50	-40	dB
VCO reference frequency deviation Rch	V_{62-3}	fundamental wave as 0dB	—	-50	-40	dB
VCO reference frequency deviation Lch	F_{DOL}	$\Delta V=\pm 195.2mV$ (-15dBs equivalent)	90	120	150	kHz
VCO reference frequency deviation Rch	F_{DOR}	$\Delta V=\pm 195.2mV$ (-15dBs equivalent)	45	60	75	kHz
Maximum frequency deviation 1 Lch	F_{DLMX1}	input $\Delta V=-617mV$ (-5dBs equivalent)	96	110	128	kHz
Maximum frequency deviation 2 Lch	F_{DLMX2}	input $\Delta V=+617mV$ (-5dBs equivalent)	-128	-110	-96	kHz
Maximum frequency deviation 1 Rch	F_{DRMX1}	input $\Delta V=-617mV$ (-5dBs equivalent)	48	55	64	kHz
Maximum frequency deviation 2 Rch	F_{DRMX2}	input $\Delta V=+617mV$ (-5dBs equivalent)	-64	-55	-48	kHz
Boost start time Lch, Rch, at recording	T_{BSL} T_{BSR}	time from PG input	—	—	200	μs
Boost level Lch, Rch	V_{BSL} V_{BSR}	level difference due to gain-up	6	—	9	dB
Boost width Lch, Rch	T_{BEL} T_{BER}	time of gain-up	1.1	1.3	1.5	ms
Reference FM modulation distortion factor Lch, Rch	T_{HDL} T_{HDR}	$V_{IN}=-15dBs$, $f=1kHz$ THD 5th after demodulation	—	—	0.3	%
FM demodulation output Lch	V_{DEL1}	$DEV=\pm 60kHz$ $f_m=400Hz$	-18	-15	-12	dBs
FM demodulation output Rch	V_{DER1}	$DEV=\pm 30kHz$ $f_m=400Hz$	-18	-15	-12	dBs
FM demodulation output distortion ratio Lch	T_{HDEL1}	$DEV=\pm 60kHz$ $f_m=1kHz$	—	—	0.3	%
FM demodulation output distortion ratio Rch	T_{HDER1}	$DEV=\pm 30kHz$ $f_m=1kHz$	—	—	0.3	%
Dropout detection ON level	DODON	$V_{IN}=30mV_{P-P}$ as 0dB $f=1.5MHz$	-11	-14	-18	dB

■ Electrical Characteristics (cont.) ($V_{CC1} = 4.75V$, $V_{CC2} = 8.2V$, $T_a = 25 \pm 2^\circ C$) (AN3986FHP)

Parameter	Symbol	Condition	min	typ	max	Unit
Dropout off hysteresis width	DODOFF	$V_{in} = 30mV_{P-P}$ as 0dB	2	4	6	dB
MUTE change-over ON level	MUTON	$V_{in} = 30mV_{P-P}$ as 0dB $f = 1.5MHz$	-9	-12	-16	dB
MUTE OFF hysteresis	MUTOFF	$V_{in} = 30mV_{P-P}$ as 0dB	1	3	5	dB
AUTO MONO detection level	V_{ATMS}	$V_{in} = 30mV_{P-P}$ as 0dB $f = 1.7MHz$	-9	-12	-16	dB
AUTO MONO OFF hysteresis	V_{ATME}	$V_{in} = 30mV_{P-P}$ as 0dB	0.5	2.0	4	dB
Hold start time Lch	T_{HOSL}	time from PG input to hold start	1.0	1.5	2.0	μs
Hold start time Rch	T_{HOSR}		1.0	1.5	2.0	μs
Hold end time Lch	T_{HOFL}	time from PG input to hold end	8.5	10.0	11.5	μs
Hold end time Rch	T_{HOFR}		12.2	14.0	15.8	μs
Bilingual discrimination level	V_{BIS1}	Boost level	3	—	—	dB
Bilingual discrimination level hysteresis	V_{BIE1}		0.5	2	4	dB
Self recording playback level Lch	V_{RPL}	$V_{in} = -20dBs$, $f = 400Hz$ bilingual MODE	-9.5	-7.0	-4.5	dBs
Self recording playback level Rch	V_{RPR}		-8.5	-6.0	-3.5	dBs
Self recording playback level (R/L) channel balance	B_{RPL}	$V_{in} = -20dBs$, $f = 400Hz$ V_{RPR}/V_{RPL}	0	1.0	2.0	dB
Rec. holding voltage	V_{22R}		0	—	1.4	V
PB holding voltage	V_{22P}		3.4	—	4.75	V
Line mute ON voltage	V_{18MN}		3.4	—	4.75	V
Line mute OFF voltage	V_{18MF}		0	—	1.4	V
Input change-over selection voltage LINE 1	V_{191}		3.9	—	4.75	V
Input change-over selection voltage LINE 2	V_{192}		2.1	—	2.7	V
Input change-over selection voltage LINE 3	V_{193}		0	—	0.8	V
SP mode holding voltage	V_{42S}		3.4	—	4.75	V
LP mode holding voltage	V_{42L}		0	—	1.4	V
Output change-over selection voltage Lch	V_{43H}		3.9	—	4.75	V
Output change-over selection voltage Rch	V_{43M}		2.1	—	2.7	V
Output change-over selection voltage STE	V_{43L}		0	—	0.8	V
Matrix control holding voltage ON	V_{44H}		3.9	—	4.75	V
Matrix control holding voltage AUTO	V_{44M}		2.1	—	2.7	V
Matrix control holding voltage OFF	V_{44L}		0	—	0.8	V
PG input voltage high level	V_{74H}		3.4	—	4.75	V
PG input voltage low level	V_{74L}		0	—	1.4	V
Discrimination output voltage BIL	V_{17H}		3.4	—	4.75	V
Discrimination output voltage MON	V_{17M}		1.5	—	2.6	V
Discrimination output voltage STE	V_{17L}		0	—	0.8	V

■ Electrical Characteristics ($V_{CC1}=4.75V$, $V_{CC2}=8.2V$, $T_a=25\pm 2^\circ C$) (AN3986FBP)

Parameter	Symbol	Condition	min	typ	max	Unit
Circuit current 1	I_{R37}	$V_{CC1} = 4.75V$, at recording	58	73	88	mA
Circuit current 2	I_{R33}	$V_{CC2} = 8.20V$, at recording	1.6	2.0	2.4	mA
Circuit current 1	I_{P37}	$V_{CC1} = 4.75V$, at recording	61	77	93	mA
Circuit current 2	I_{P33}	$V_{CC2} = 8.20V$, at recording	1.6	2.0	2.4	mA
Line AGC output level Lch, Rch	V_{OALL} V_{OALR}	$V_{IN} = 20dBs$ $f = 400Hz$	-8	-7	-6	dBs
Line AGC output distortion rate Lch, Rch	T_{HALL1} T_{HALR1}	$V_{IN} = 20dBs$ $f = 1kHz$, THD 5th	—	0.02	0.1	%
AGC ON output level Lch, Rch	V_{OALL2} V_{OALR2}	$V_{IN} = -20dBs$ $f = 400Hz$	-4	-1	+2	dBs
AGC ON output distortion rate Lch, Rch	T_{HALL2} T_{HALR2}	$V_{IN} = -20dBs$ $f = 1kHz$, THD 5th	—	0.2	0.4	%
Line AGC output noise Lch, Rch	V_{NALL} V_{NALR}	No input A curve filter	—	-78	-74	dBs
Fade control maximum attenuation output Lch, Rch	V_{FALL} V_{FALR}	$V_{IN} = -20dBs$, 1kHz A curve filter	—	-80	-75	dBs
Line through monitor output level Lch, Rch	V_{OILL} V_{OILR}	$V_{IN} = -20dBs$, 400Hz	-8	-7	-6	dBs
Line through monitor output noise Lch, Rch	V_{NLLL} V_{NLLR}	No input A curve filter	—	-81	-77	dBs
Between inputs between channels crosstalk	V_{CTIN}	$V_{IN} = -14dBs$, 1kHz A curve filter	—	-78	-74	dBs
E-E monitor output frequency characteristics Lch, Rch	V_{OLFL} V_{OLFR}	$V_{IN} = -20dBs$ ratio of 40kHz/400Hz	—	-5.5	-2.5	dB
HP output level $V_{OL} = CENTER$ Lch, Rch	V_{HC8L} V_{HC8R}	$V_{IN} = -20dBs$, 400Hz 8Ω load	-28	-26	-24	dBs
HP output distortion factor $V_{OL} = CENTER$ Lch, Rch	T_{HHC8L} T_{HHC8R}	$V_{IN} = -20dBs$, 1kHz 8Ω load, THD 5th	—	0.05	0.5	%
HP output level $V_{OL} = max.$ Lch, Rch	V_{HH8L} V_{HH8R}	$V_{IN} = -20dBs$, 400Hz 8Ω load	-18	-16	-14	dBs
HP output level $V_{OL} = min.$ Lch, Rch	V_{HL8L} V_{HL8R}	$V_{IN} = -20dBs$, 400Hz 8Ω load	—	-96	-92	dBs
HP output noise voltage $V_{OL} = CENTER$ Lch, Rch	V_{NHC0L} V_{NHCOR}	No input A curve filter	—	-96	-92	dBs
HP maximum output level $V_{OL} = CENTER$ Lch, Rch	V_{MH8L} V_{MH8R}	1kHz, at 1% distortion, 8Ω load THD 5th	-18	—	—	dBs
Encode output level Lch, Rch	V_{ORLL} V_{ORLR}	$V_{IN} = -20dBs$, 400Hz BIL mode	-18	-15	-12	dBs
Encode output distortion factor Lch, Rch	T_{HORLL} T_{HORLR}	$V_{IN} = -20dBs$, 1kHz to THD 5th	—	0.2	0.4	%
Encode linearity Lch, Rch	V_{OXLL} V_{OXLR}	$V_{IN} = -11.2/-51.2dBs$ $f = 400Hz$	-21	-20	-19	dB
SP encode f characteristics Lch, Rch	V_{FORLL} V_{FORLR}	$V_{IN} = -20dBs$ $f = 10kHz/400Hz$	3.8	4.8	5.8	dB
LP encode f characteristics Lch, Rch	V_{FLRLL} V_{FLRLR}	$V_{IN} = -20dBs$, 10kHz ratio of LP/SP	2.0	3.0	4.0	dB
Encode output noise Lch, Rch	V_{NRLL} V_{NRRR}	No input A curve filter	—	-55	-51	dB
ST/BIL level difference L + R Lch	V_{BSRLL}	$V_{IN} = -20dBs$, 400Hz	-0.5	0	+0.5	dB
ST/BIL level difference L - R Rch	V_{BSRLR}	$V_{IN} = -20dBs$, 400Hz 30kHz LPF	—	-30	-17.5	dB
MON/BIL level difference Lch	V_{BMRLR}	$V_{IN} = -20dBs$, 400Hz	-0.5	0	+0.5	dB
Decode reference output level Lch, Rch	V_{OLPL} V_{OLPR}	V_{OLL} , input V_{ORLR}	-9.5	-7	-4.5	dB











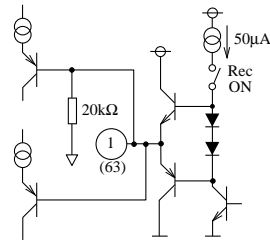

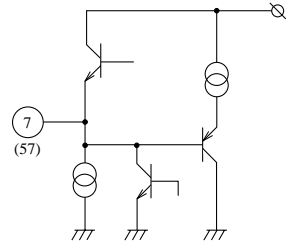

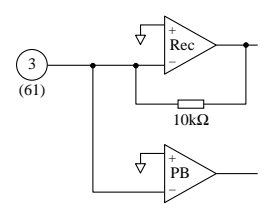

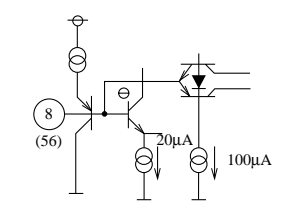

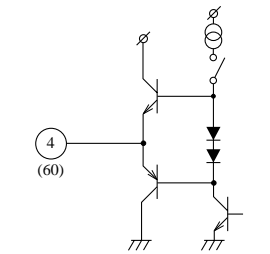
■ Electrical Characteristics (cont.) ($V_{CC1}=4.75V$, $V_{CC2}=8.2V$, $T_a=25\pm 2^\circ C$) (AN3986FBP)

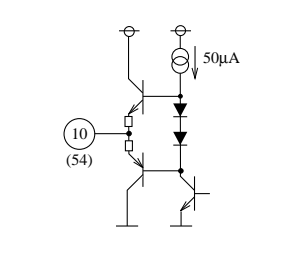
Parameter	Symbol	Condition	min	typ	max	Unit
Decode reference output distortion rate Lch, Rch	T_{HOLPL} T_{HOLPR}	V_{ORLL} , input V_{ORLR}	—	0.12	0.3	%
Decode linearity Lch, Rch	V_{OXPL} V_{OXPR}	$V_{IN}=-11.6/-41.6dBs$ $f=400Hz$	-63	-60	-57	dB
Decode output noise Lch, Rch	V_{NLPL} V_{NLPR}	No input A curve filter	—	-87	-79	dBs
Crosstalk Lch, Rch, at playback	C_{ERL} C_{ERR}	$V_{IN}=-20dBs$, 1kHz A curve filter	—	—	-79	dBs
Maximum output level Lch, Rch, at playback	V_{OLML} V_{OLMR}	$V_{IN}=-10dBs$, 1kHz THD 5th	—	0.4	1.0	%
Line mute attenuation quantity Lch, Rch	V_{MLML} V_{MLMR}	$V_{IN}=-20dBs$, 1kHz A curve filter	—	-92	-87	dBs
Encode channel crosstalk Lch, Rch	S_{ERL} S_{ERR}	$V_{IN}=-14dBs$, 1kHz A curve filter	—	-50	-47	dBs
E-E system monitor output channel balance	B_{AL}	V_{OALR}/V_{OALL}	-0.55	0	+0.55	dB
Encode output channel balance	B_{RE}	V_{ORLR}/V_{ORLL}	-2	0	+2	dB
Decode output channel balance	B_{LP}	V_{OLPR}/V_{OLPL}	-3	0	+3	dB
VCO free-run frequency Lch	F_{OL}	$R=8.2k\Omega$	1.35	1.50	1.65	MHz
VCO free-run frequency Rch	F_{OR}	$R=6.8k\Omega$	1.55	1.70	1.85	kHz
VCO output amplitude voltage Lch	V_{83}	when $f=1.5MHz$	456	500	548	mV _{P-P}
VCO output amplitude voltage Rch	V_{65}	when $f=1.7MHz$	410	450	493	mV _{P-P}
VCO 2nd harmonics output Lch	V_{83-2}	fundamental wave as 0dB	—	-50	-35	dB
VCO 2nd harmonics output Rch	V_{65-2}	fundamental wave as 0dB	—	-50	-35	dB
VCO 3rd harmonics output Lch	V_{83-3}	fundamental wave as 0dB	—	-50	-40	dB
VCO 3rd harmonics output Rch	V_{65-3}	fundamental wave as 0dB	—	-50	-40	dB
VCO reference frequency deviation Lch	F_{DOL}	$\Delta V=\pm 195.2mV$ (-15dBs equivalent)	90	120	150	kHz
VCO reference frequency deviation Rch	F_{DOR}	$\Delta V=\pm 195.2mV$ (-15dBs equivalent)	45	60	75	kHz
Maximum frequency deviation 1 Lch	F_{DLMX1}	input $\Delta V=-617mV$ (-5dBs equivalent)	96	110	128	kHz
Maximum frequency deviation 2 Lch	F_{DLMX2}	input $\Delta V=+617mV$ (-5dBs equivalent)	-128	-110	-96	kHz
Maximum frequency deviation 1 Rch	F_{DRMX1}	input $\Delta V=-617mV$ (-5dBs equivalent)	48	55	64	kHz
Maximum frequency deviation 2 Rch	F_{DRMX2}	input $\Delta V=+617mV$ (-5dBs equivalent)	-64	-55	-48	kHz
Boost start time Lch, Rch, at recording	T_{BSL} T_{BSR}	time from PG input	—	—	200	μs
Boost level Lch, Rch	V_{BSL} V_{BSR}	level difference due to gain-up	6	—	9	dB
Boost width Lch, Rch	T_{BEL} T_{BER}	time of gain-up	1.1	1.3	1.5	ms
Reference FM modulation distortion ratio Lch, Rch	T_{HDL} T_{HDR}	$V_{IN}=-15dBs$, $f=1kHz$ THD 5th after demodulation	—	—	0.3	%
FM demodulation output voltage Lch	V_{DEL1}	$DEV=\pm 60kHz$ $f_m=400Hz$	-18	-15	-12	dBs
FM demodulation output voltage Rch	V_{DER1}	$DEV=\pm 30kHz$ $f_m=400Hz$	-18	-15	-12	dBs
FM demodulation output distortion ratio Lch	T_{HDEL1}	$DEV=\pm 60kHz$ $f_m=1kHz$	—	—	0.3	%
FM demodulation output distortion ratio Rch	T_{HDER1}	$DEV=\pm 30kHz$ $f_m=1kHz$	—	—	0.3	%
Dropout detection ON level	DODON	$V_{IN}=30mV_{P-P}$ as 0dB $f=1.5MHz$	-11	-14	-18	dB

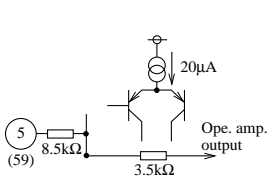
■ Electrical Characteristics (cont.) ($V_{CC1}=4.75V$, $V_{CC2}=8.2V$, $T_a=25\pm 2^\circ C$) (AN3986FBP)

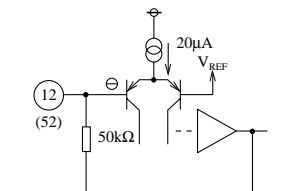
Parameter	Symbol	Condition	min	typ	max	Unit
Dropout off hysteresis width	DODOFF	$V_{in}=30mV_{P-P}$ as 0dB	2	4	6	dB
MUTE change-over ON level	MUTON	$V_{in}=30mV_{P-P}$ as 0dB $f=1.5MHz$	-9	-12	-16	dB
MUTE OFF hysteresis	MUTOFF	$V_{in}=30mV_{P-P}$ as 0dB	1	3	5	dB
AUTO MONO detection level	V_{ATMS}	$V_{in}=30mV_{P-P}$ as 0dB $f=1.7MHz$	-9	-12	-16	dB
AUTO MONO OFF hysteresis	V_{ATME}	$V_{in}=30mV_{P-P}$ as 0dB	0.5	2.0	4	dB
Hold start time Lch	T_{HOSL}	time from PG input to hold start	1.0	1.5	2.0	μs
Hold start time Rch	T_{HOSR}		1.0	1.5	2.0	μs
Hold end time Lch	T_{HOFL}	time from PG input to hold end	8.5	10.0	11.5	μs
Hold end time Rch	T_{HOFR}		12.2	14.0	15.8	μs
Bilingual discrimination level	V_{BIS1}	Boost level	3	—	—	dB
Bilingual discrimination level hysteresis	V_{BIE1}		0.5	2	4	dB
Self recording playback level Lch	V_{RPL}	$V_{in}=-20dBs$, $f=400Hz$ bilingual MODE	-9.5	-7.0	-4.5	dBs
Self recording playback level Rch	V_{RPR}		-8.5	-6.0	-3.5	dBs
Self recording playback level (R/L) channel balance	B_{RPL}	$V_{in}=-20dBs$, $f=400Hz$ V_{RPR}/V_{RPL}	0	1.0	2.0	dB
Rec holding voltage	V_{23R}		0	—	1.4	V
PB holding voltage	V_{23P}		3.4	—	4.75	V
Line MUTE ON voltage	V_{19MN}		3.4	—	4.75	V
Line MUTE OFF voltage	V_{19MF}		0	—	1.4	V
Input change-over selection voltage LINE 1	V_{201}		3.9	—	4.75	V
Input change-over selection voltage LINE 2	V_{202}		2.1	—	2.7	V
Input change-over selection voltage LINE 3	V_{203}		0	—	0.8	V
SP mode holding voltage	V_{44S}		3.4	—	4.75	V
LP mode holding voltage	V_{44L}		0	—	1.4	V
Output change-over selection voltage Lch	V_{45H}		3.9	—	4.75	V
Output change-over selection voltage Rch	V_{45M}		2.1	—	2.7	V
Output change-over selection voltage STE	V_{45L}		0	—	0.8	V
Matrix control holding voltage ON	V_{46H}		3.9	—	4.75	V
Matrix control holding voltage AUTO	V_{46M}		2.1	—	2.7	V
Matrix control holding voltage OFF	V_{46L}		0	—	0.8	V
PG input voltage high level	V_{78H}		3.4	—	4.75	V
PG input voltage low level	V_{78L}		0	—	1.4	V
Discrimination output voltage BIL	V_{18H}		3.4	—	4.75	V
Discrimination output voltage MON	V_{18M}		1.5	—	2.6	V
Discrimination output voltage STE	V_{18L}		0	—	0.8	V

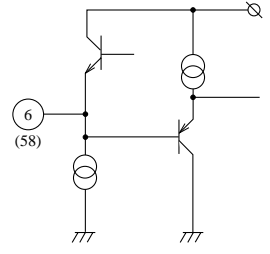
■ Pin Descriptions (V_{CC} or GND pins are not shown)

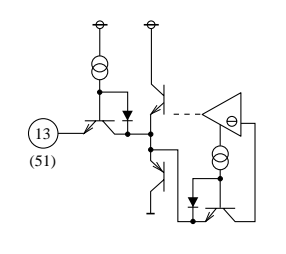
Pin No.	Waveform · Voltage	Equivalent circuit	Pin No.	Waveform · Voltage	Equivalent circuit
1 [1] · 63 [60]	 2.38 VDC, Rec NR output		7 [7] · 57 [54]		
3 [3] · 61 [58]	 DC 2.38V		8 [8] · 56 [53]	 DC 1.65V L.S IN	
4 [4] · 60 [57]	 DC 2.38V		10 [10] · 54 [51]	 DC 2.38V LPF OUT	
5 [5] · 59 [56]	 DC 2.38V LP EMPH		12 [11] · 52 [50]	 DC 2.38V CCA IN	
6 [6] · 58 [55]			13 [12] · 51 [49]	 DC 2.38V CCA OUT	











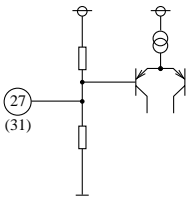

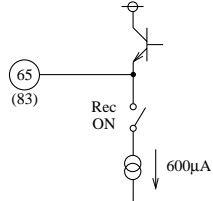

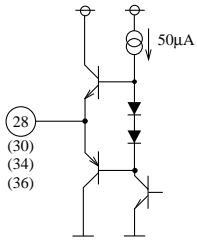
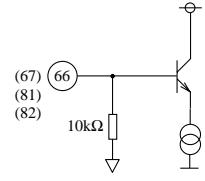
Note) The indicated values are typical ones, and may depend on operating conditions or individual IC.
 $V_{CC1} = 4.75V$, and $V_{CC2} = 8.2V$
 A number without a square denotes a pin No. of the AN3986FBP, while a number with a square denotes a pin No. of the AN3986FHP.

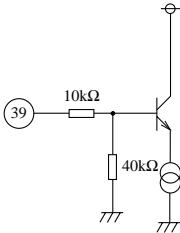
■ Pin Descriptions (cont.) (V_{CC} or GND pins are not shown)

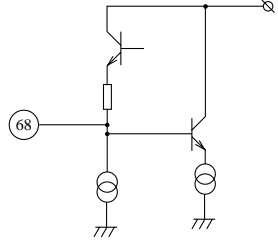
Pin No.	Waveform · Voltage	Equivalent circuit	Pin No.	Waveform · Voltage	Equivalent circuit
14 13 50 48	AC sine wave DC 2.38V CCA IN		19 18	MUTE SW	
15 14 49 47	AC sine wave 2.38 VDC, Buffer OUT		20 19 45 43 46 44	DC 2.38V	
16 15 46	AC sine wave DC 2.38V		22 21 24 23 26 25 38 36 40 38 42 40	DC 2.38V	
17 16 45	AC sine wave DC 2.38V		23 22	R/P SW	
18 17	DC 2.38V		25 24	DC 2.38V	

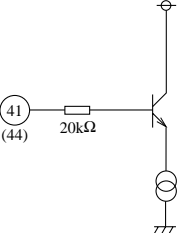
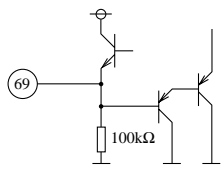
Note) The indicated values are typical ones, and may depend on operating conditions or individual IC.
 $V_{CC1}= 4.75V$, and $V_{CC2}= 8.2V$
 A number without a square denotes a pin No. of the AN3986FBP, while a number with a square denotes a pin No. of the AN3986FHP.

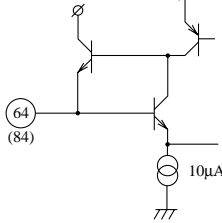
■ Pin Descriptions (cont.) (V_{CC} or GND pins are not shown)

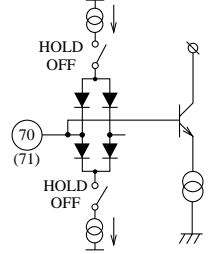
Pin No.	Waveform · Voltage	Equivalent circuit	Pin No.	Waveform · Voltage	Equivalent circuit
27 [26] · 31 [30]	 $V_{REF IN}$		65 [62] · 83 [79]	 DC $f=1.5\text{MHz}$ (1.7MHz) FM modulation output	
28 [27] · 30 [29] · 34 [32] · 36 [34]	 DC 2.38V 4.1V		66 [63] · 67 [64] · 81 [77] · 82 [78]	DC 2.38V RF IN	
39 [37]			68 [65]		
41 [39] · 44 [42]			69 [66]	4VDC when not active, and 0VDC when active	
64 [61] · 84 [80]	 DC 2.3V		70 [67] · 71 [68]		

Note) The indicated values are typical ones, and may depend on operating conditions or individual IC.
 $V_{CC1}=4.75\text{V}$, and $V_{CC2}=8.2\text{V}$
 A number without a square denotes a pin No. of the AN3986FBP, while a number with a square denotes a pin No. of the AN3986FHP.

■ Pin Descriptions (cont.) (V_{CC} or GND pins are not shown)

Pin No.	Waveform · Voltage	Equivalent circuit	Pin No.	Waveform · Voltage	Equivalent circuit
73 70			72 69	—	
76 72			79 75	—	
78 74	f=30Hz, square wave		—	—	—

Note) The indicated values are typical ones, and may depend on operating conditions or individual IC.
 $V_{CC1} = 4.75V$, and $V_{CC2} = 8.2V$
 A number without a square denotes a pin No. of the AN3986FBP, while a number with a square denotes a pin No. of the AN3986FHP.

■ Reference

Power dissipation for the package
AN3986FHP $P_D - T_a$

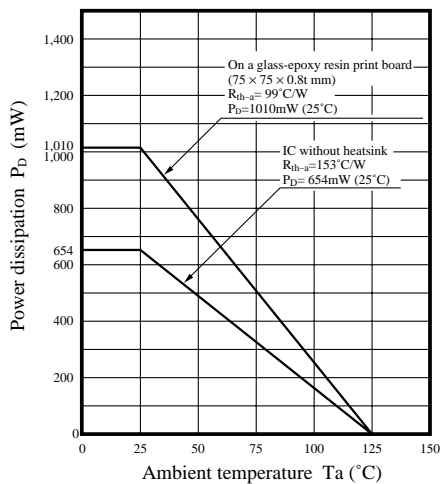

NR decoder linearity characteristics

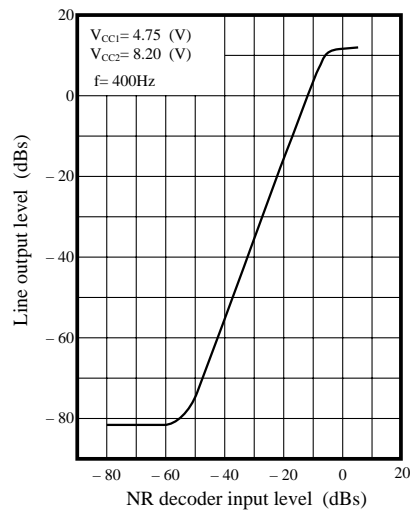

■ Reference (cont.)

Line AGC input/output characteristics

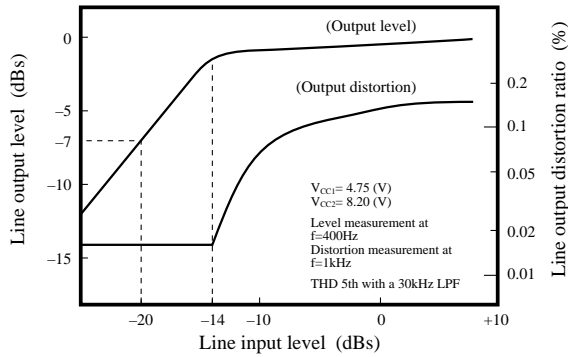

Temperature characteristics of FM record output deviation

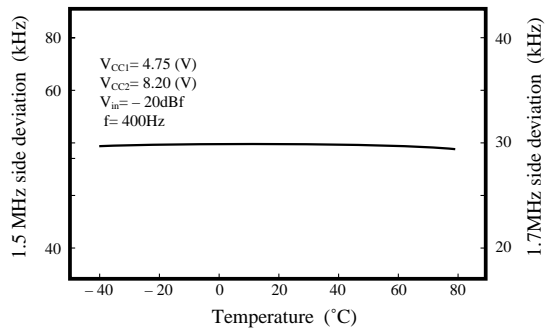

Fade control output characteristics

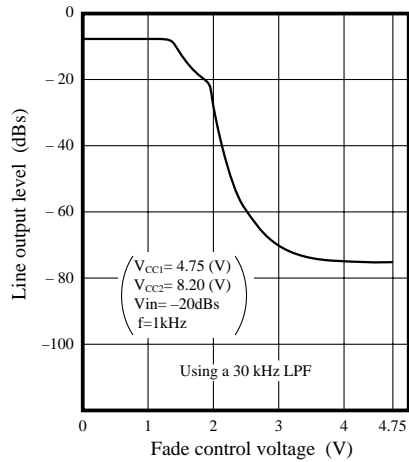

Line maximum output level

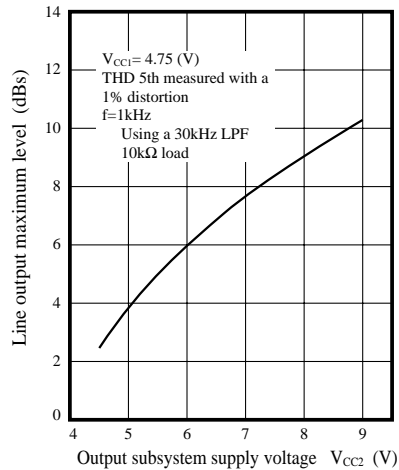

Carrier level vs. FM demodulator output noise

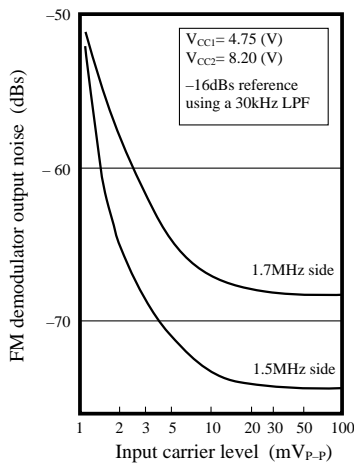

Headphone volume control output

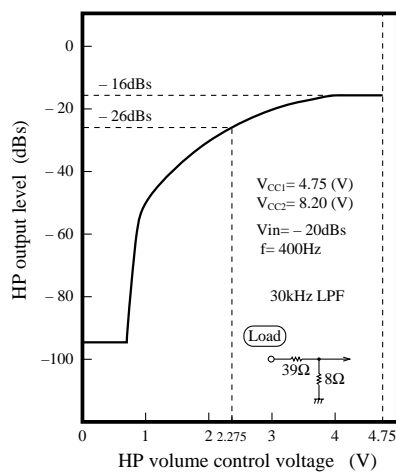

This datasheet has been downloaded from:

www.DatasheetCatalog.com

Datasheets for electronic components.



LittleDiode supplies new, hard to find or obsolete electronic components and semiconductors all over the world.

With over two million different components listed you are sure to find the part you need.

Feel free to visit us today at our online store:

LittleDiode.com

Looking forward to providing you with the best possible service.