



---

MICROCONTROLLER AND TRIACS  
ON THE 110/240V MAINS

---

by P. Rabier/L. Perier

## INTRODUCTION

Today, electronics is used in home appliances for purposes as different as the motor regulation of a washing machine, the control of a vacuum cleaner, the light dimming of a lamp or the heating in a coffee machine. This pervasion increases rapidly because appliances require enhanced features, easy to built and modify while electronics based solutions become cheaper and more sophisticated.

Within this evolution, the microcontrollers (MCU) progressively replace analog controllers and discrete solutions even in low cost applications. They are more flexible, often need less components and provide faster time to market. With an analog IC, the designer is limited to a fixed function frozen inside the device. With a DIAC control, features like sensor feedback or enhanced motor drive can not be easily implemented. With the MCU proposed in this note (the ST6210), the designer can include his own ideas and test them directly using EPROM or One Time Programmable (OTP) versions.

The triac is the least expensive power switch to operate directly on the 110/240V mains. Thus it is the optimal switch for most of the low-cost power applications operating on-line. The LOGIC LEVEL or SNUBBERLESS triacs are a complement to the ST6210 MCU for such appliances. These triacs can operate with low gate current and can be directly triggered by the MCU, while still maintaining a high switching capability.

This application note describes three different MCU based applications: a universal motor drive, an AC switch and a light dimmer. They all operate with the same user interfaces and almost the same software and hardware.

## UNIVERSAL MOTOR DRIVE

### Basic function

Universal motor drives with DIAC or analog controllers are currently used today. These circuits have the disadvantage of requiring many external components when controls include sophisticated features such as speed control with torque limiting or when parameters have to be easily changed from one design to another. They are also limited in the choice of user interfaces.

A universal motor drive circuit, supplied directly from the 110V/240V mains has been realized using a MCU ST6210 and a SNUBBERLESS triac. The user interface is a touch sensor, a push button or a potentiometer. The board includes a minimum of components in order to save cost and size. The auxiliary supply is derived from the mains voltage.

### Power control

The power device is a triac because it is the most economical on-line switch. The output power, and therefore the motor speed, are controlled by the phase delay of the triac drive. This delay is referred to the zero crossing of the line voltage which is detected by means of a connection to the mains neutral (fig.1). Changing operation from 60Hz to 50Hz can be achieved by making simple modifications to the MCU EPROM/ROM table defining the triac conduction angle versus power level. Automatic selection of the 50Hz/ 60Hz tables could be done.

Figure 1. Mains synchronisation

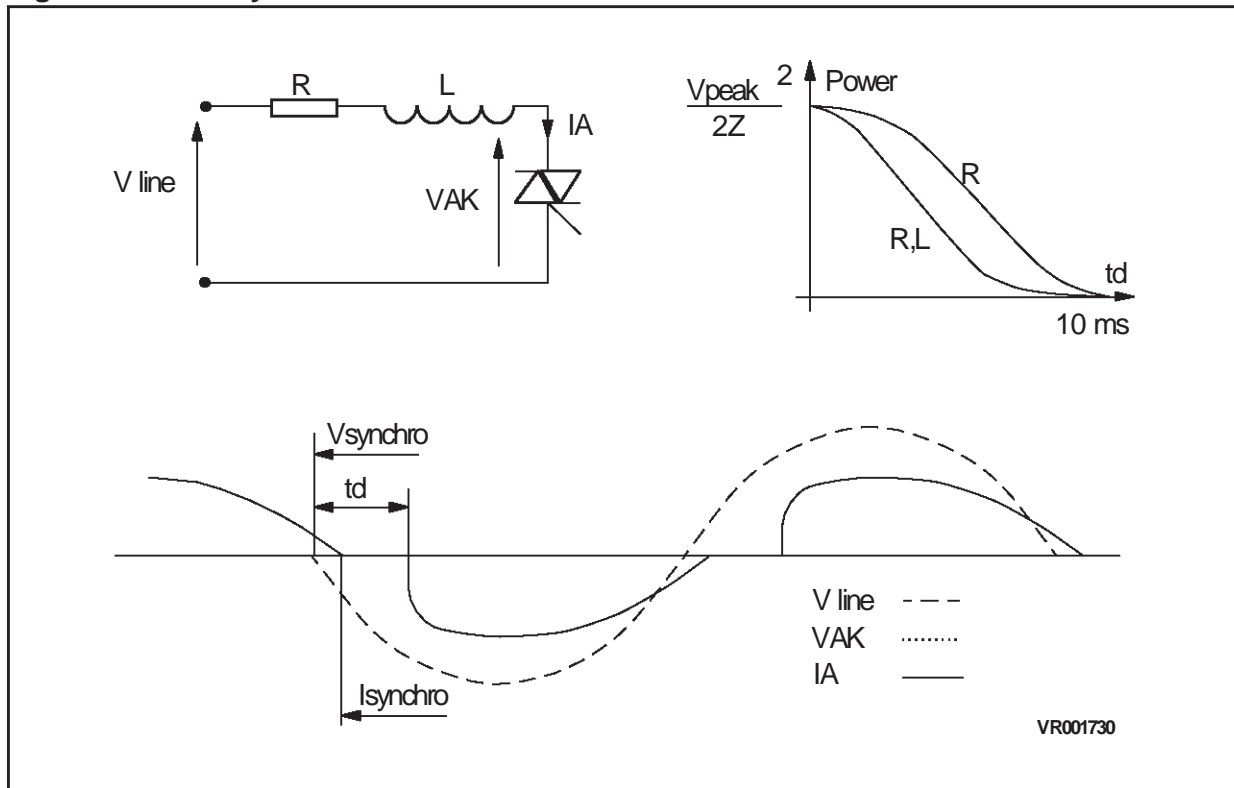

A universal motor is an inductive load which may generate very strong dynamic constraints on the circuit at turn-off. Because of the phase lag of current with respect to voltage, the reapplied voltage can be different from zero. So the leading edge of the reapplied voltage across the triac can be very sharp because it is limited only by parasitic capacitances (fig.8). A SNUBBERLESS triac is well adapted to this kind of loads because fast commutation characteristics can be obtained with low current rating devices. Otherwise, inrush current at motor startup is limited by the soft start feature included in the control.

**Triac drive**

The triac is directly driven by the MCU. The pulse driving the triac is short (100s) in order to minimize the +5V supply circuit size. The SNUBBERLESS triac is driven in quadrants QII and QIII with 60 mA gate current provided by three I/O bits of the ST6210 in parallel. This pulse is sufficiently long to insure the triac is latched at the end of the pulse. Pulse length can be modified if another triac or motor is used.

**User Interfaces**

There are three different user interfaces: a touch control, a push button and a potentiometer. Four modes can be selected on the board in order to define how the transmitted power is related to the user interface.

Three modes operate with the touch sensor or the push button. Dimming is obtained when the sensor or the button is touched for more than 330ms. If the touch duration is between 50ms and 330ms, the circuit is switched on or off. A contact of less than 50ms causes no action. Modes 1,2,3 differ in the way the motor speed is changed by sensor or button contact. (These values are given for the 60Hz version, for a 50Hz mains values are respectively 400ms and 50ms).

**Figure 2. User interfaces**

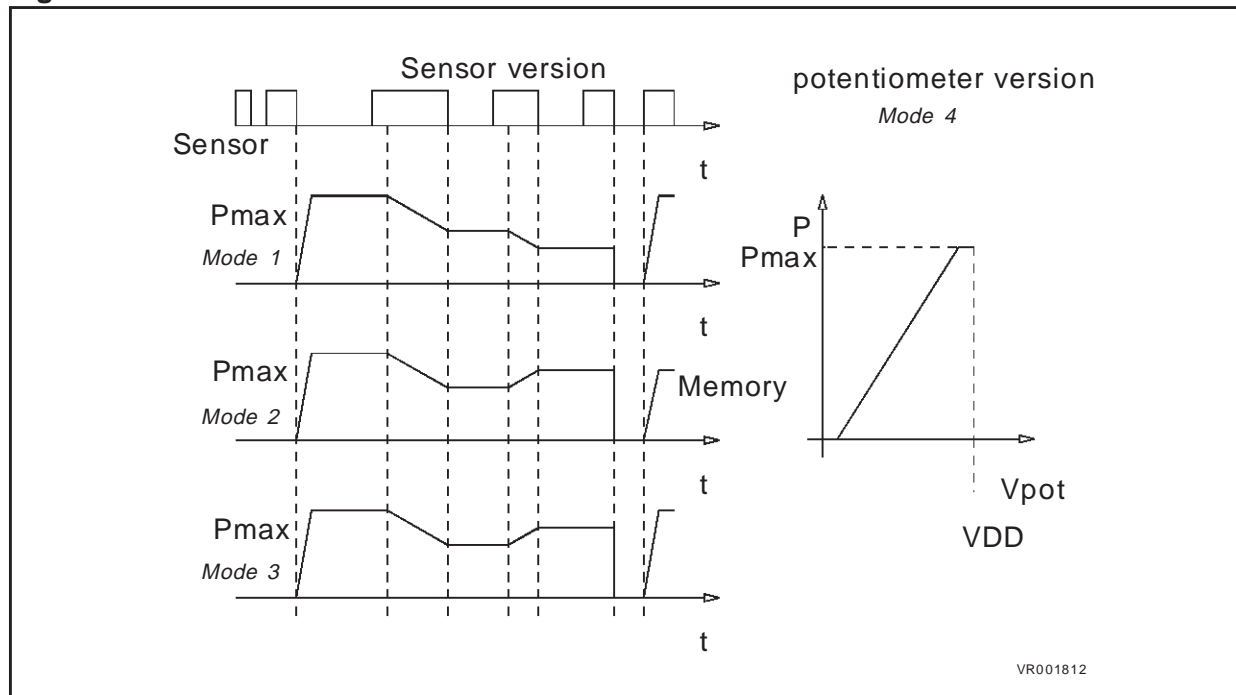
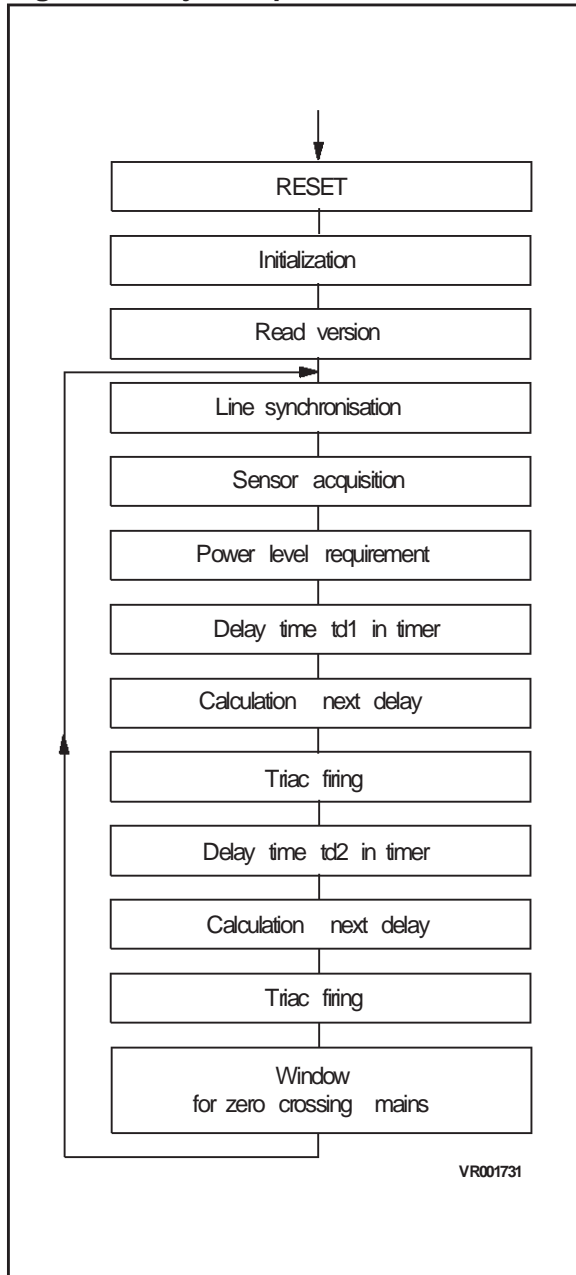



Figure 4. Major steps of the software



Total consumption of the board is 3mA with an 8MHz oscillator. The board supply comes from the mains through a simple RCD circuit. The +5V is referred to anode 1 of the triac in order to provide the negative gate current necessary to drive the triac in quadrants QII and QIII. The 5V supply capacitance is mounted as near as possible to the MCU with very short interconnecting traces to maximize RFI immunity.

The touch sensor is a voltage divider between line and neutral. It operates when the +5V supply input of the circuit is connected to the line potential. This connection to the mains must be provided.

### Software

All operating features are contained in a 700 byte program. More than 1byte of ROM is available for additional features. The architecture of the software is modular in order to provide maximum flexibility.

A lockup table relating delay time to the power requirement contains 64 different levels. The conduction time of the triac can vary from 1.7ms to 6.7ms for a 60Hz application and from 2ms to 8ms to a 50Hz application. The user can easily adjust the minimum and maximum power levels because the corresponding delay times are slowly changing at the top and bottom of the table. The table can be modified in ROM/EPROM to meet different conditions e.g. 50Hz or 60Hz operation or varying loads.

One software version covers all four user interface modes without hardware change.

All inputs are digitally filtered so that an input is validated only if it remains constant for 15s or more. So, passive filter components can be saved. The mains supply carries disturbances (glitches, telecommand signals, ...) which could disturb the triac drive. For this reason, a mains voltage zero crossing is only

## MCU AND TRIAC ON THE MAINS

validated if it occurs during a window of time (1.7ms each 16.6ms for 60Hz operation and 2ms each 200ms for 50Hz operation) selected by the internal timer of the MCU. This block acts as a filter and again eliminates external components (fig.4).

This circuit can be used as a basis for development of more sophisticated features such as vacuum regulation in a vacuum cleaner, speed control in a food processor, speed regulation with torque limiting in a drill, unbalance detection in a washing machine or door opener with remote control.

### AC SWITCH

AC switches operate as relays. They have to turn-on as soon as possible after a mains voltage zero crossing in order to prevent the disturbances induced by a sharp leading edge of current. Their operating current has to be small in order to minimize the supply coming from the mains. Also, they are usually driven through isolated interfaces such as an optocoupler or transformer.

The motor drive circuit described previously can be used as a basis for such applications. When the zero crossing of the mains voltage is detected, this triac is turned-on.

A SNUBBERLESS triac such as the BTA 16-600BW is suitable for an AC switch. Its switching characteristics ( $[di/dt]_c > 14A/ms$ ) allows it to control various types of resistive and inductive loads.

**Figure 5. Delay time in drive of an AC switch**

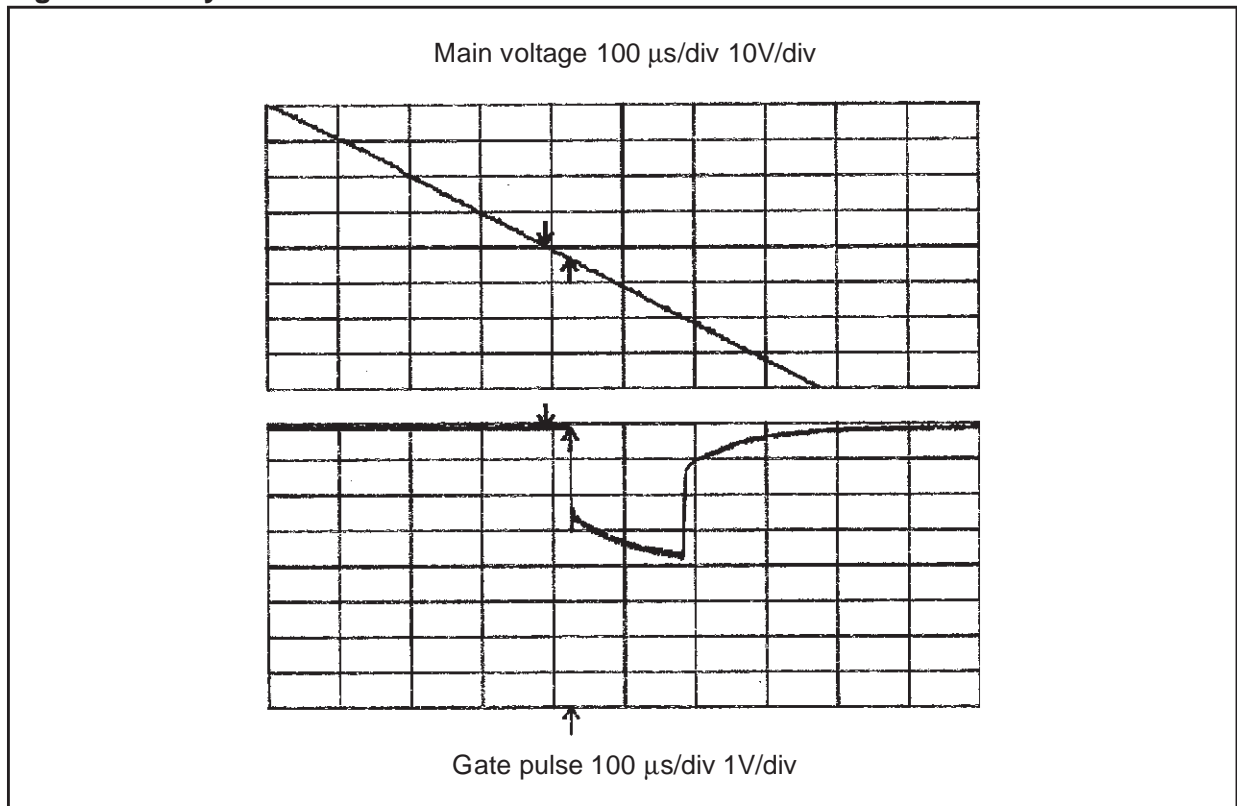

The figure 5 shows that a ST6210 can turn-on a triac 35ms after the mains voltage zero crossing. With such phase delay ( $0.75^\circ/60\text{Hz}$  and  $0.63^\circ/50\text{Hz}$ ), the voltage reapplied across the load is small (V) and the leading edge of current is minimal.

Such an AC switch can include additional features such as voltage and current monitoring or feedback features. This AC switch can also be used, for instance, in a refrigerator (with smaller triacs) with several compartments where the MCU controls different temperatures. The MCU can then interface the sensors, solve the priority conflicts and drive the AC switches with the optimal sequence.

## LIGHT DIMMER

### Basic function

The motor drive board can also operate as a light dimmer. However, the board can be slightly modified such that the neutral connection is no longer necessary. Then, the board can be plugged in series with the line wire like a mechanical switch. The synchronization and the auxiliary supply are obtained from the voltage across the triac (Fig.6).

A light dimmer operating directly on the 110V or 240V mains has been realized using a MCU ST6210 and a LOGICLEVEL triac. This circuit drives halogen or incandescent lamps supplied directly from the mains or through a low voltage transformer. It includes softstart and protection against transformer saturation and against open load. The user interfaces are the same as with the motor drive.

Figure 6. Light dimmer circuit diagram

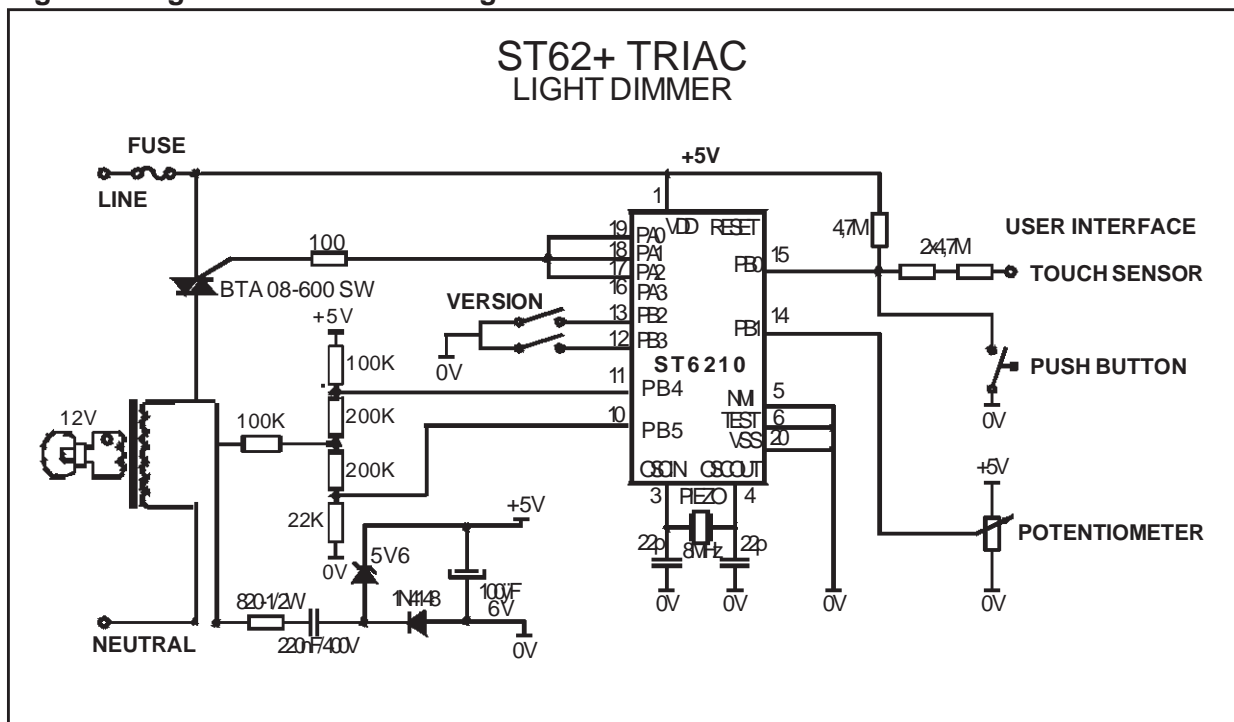

### Power control

Power is controlled by the phase delay ( $t_d$ ) of the triac drive. In the previous design,  $t_d$  is referred to the zero crossing of the line voltage. In order to avoid a connection to the mains neutral and connect the circuit directly in series with the load, the trigger delay is referred to the previous zero crossing of the current (fig.1). When the current in the triac is zero, the mains voltage is reapplied across it. Synchronization is achieved by measuring this voltage. This main voltage is monitored over each halfwave with a network of resistances connected to two I/O lines of the ST6210. This allows detection of spurious open load and the retriggering of the triac with multipulse operation if it is not latched after the first gate pulse.

### Operation with a transformer

Low power halogen spots use low voltage lamps (12V typ.) usually supplied through a low voltage transformer. Dimming these lamps is simple with this circuit thanks to the program features included in the ST6210 :

- \* At the start, the delay time between the first gate pulse and the synchronization instant is greater than 5ms. This limits induction in the transformer and the risk of saturation.
- \* The circuit starts on a positive line halfwave and stops on a negative one. Thus it starts with positive induction and stops after negative induction has been applied. This helps to minimize the size of the magnetic core material, and the current rating of the triac.
- \* The timer is precisely tuned in order to obtain 8.3ms (for 60Hz) or 10ms (for 50Hz) delay between two gate pulses. As a result, the triac is driven symmetrically in both phases so that continuous voltage in the transformer is avoided and noise in the transformer is reduced. Otherwise, the voltage across the triac is monitored to detect a spurious open load condition at the secondary of the transformer.

The inrush current at the turn-on of a lamp (halogen or incandescent) is also reduced due to the soft start feature of the circuit (fig.7).

### Triac drive

The triac is directly driven by the MCU. The pulse driving the triac is 50ms long. The LOGIC LEVEL triac is driven in quadrants QII and QIII with a gate current of 20mA provided by two I/O lines of the ST6210 in parallel. The LOGICLEVEL triac has a maximum specified gate triggering current of 10mA at 25°C.

The triac is multi-pulse driven. Therefore, inductive loads can be driven without the use of long pulse drives. As a result, the consumption on the +5V supply can be minimized and the supply circuit becomes very small. Before supplying the first drive pulse, the triac voltage is tested. If no voltage is detected, a spurious open load or a supply disconnection is assumed to have occurred and the circuit is stopped. After the first driving pulse, the triac voltage is monitored. If the triac is not ON, another pulse is sent. The same process can be repeated up to four times. Then, if the triac is still not ON, the circuit is switched off.

### Hardware

The light dimmer board is almost the same as the motor drive board (fig.6). The major differences concern the position where the voltage is measured and the triac choice. When the board is dimming a resistive load, an RFI filter should be added in order to the RFI standards (i.e. VDE 875).

In a dimmer, because of the resistive load, dynamic constraints are lower than in a motor con-

trol, so a LOGIC LEVEL triac (BTA08-400SW or BTA08-600SW) is used for safe gate current. This triac has been especially designed to operate with a MCU. It is a sensitive triac ( $I_{GT} < 10\text{mA}$ ) which can be triggered in quadrants I, II and III. This triac has high switching capabilities ( $di/dt > 3.5\text{A/ms}$ ), ( $dV/dt > 20\text{V/ms}$ ). Thus it can also operate without a snubber in this circuit.

This board is supplied when the triac is off. A minimum off-time of the triac (1.7ms/60Hz and 2ms/50 Hz) is necessary to ensure its supply. The RCD circuit is the same as the one used for the motor drive board.

### Software

The light dimmer software is practically the same as with the motor drive. The major difference concerns the mains disturbances rejection in order to prevent lamp flickering. The timing is carried out internally by the MCU timer. The period of operation can be modified to follow the variations of the mains frequency but not the spurious disturbances. The mains synchronisation signal is received every cycle.

**Figure 7. Soft start with lamps**

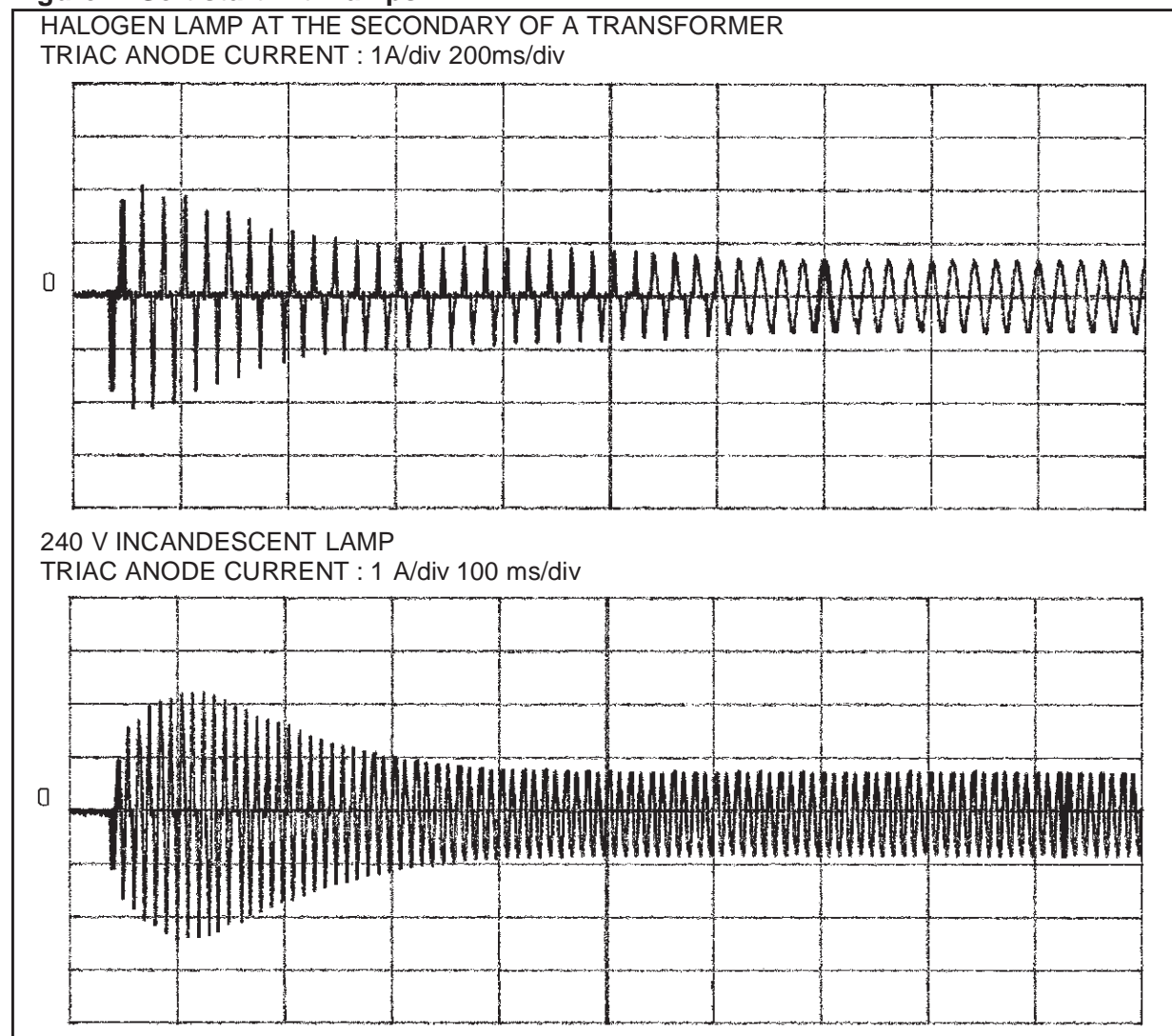

## MCU AND TRIAC ON THE MAINS

---

The corresponding mains period is measured and compared to the internal timer period.

If a difference remains after many cycles, the timer period is modified to follow the mains. This block acts like a low band filter which eliminates external filtering components.

The user interface can be modified to fit other applications such as IR presence detection or alarm, remote control, etc .

### PRACTICAL RESULTS

Figure 7 presents the soft start operation with a halogen lamp operating from the secondary of a low voltage transformer and with a high voltage tungsten filament lamp.

With soft start, the peak in-rush current is about 3 times the nominal current compared with 10 to 15 times otherwise. Therefore, the lamp life time is maximized, blowing the input fuse is prevented and the size of the triac is minimized. The figure 8 presents the current and voltage in a triac driving a universal motor.

### SUMMARY

Microcontrollers (MCU) are in common use in most areas of electronics. They are now set to penetrate the very cost sensitive area of home appliances. The applications described in this paper show that enhanced appliance circuits can be designed with fast prototyping using a ST6210 MCU and a SNUBBERLESS or LOGIC LEVEL triac. These circuits are low cost and they can provide more features with less components than classical solutions.

The presented circuits are a universal motor drive, a AC switch and a light dimmer operating from the 110/240V mains. The light dimmer drives incandescent and halogen lamps supplied either directly from the mains or through a low voltage transformer. The motor drive can be adapted, for instance, to vacuum cleaners, food processors, drills or washing machines. Those circuits include soft start and protection features. Different user interfaces can be chosen: touch sensor, push button or potentiometer.

Such features are obtained with only few components: a ST6210 MCU in 20pin DIL/SMD package with a LOGIC LEVEL or SNUBBERLESS triac in TO220 package and some passive components.

Additional features like motor speed regulation, torque limitation, vacuum or unbalance control, IR presence detection, remote control, alarm, homebus interface or electronic shortcircuit protection with IGBT/Mosfet can be implemented from these circuits.

#### Bibliography

Thyristors and triacs application manual 1986 / STMicroelectronics Universal Motor Speed Control / P.Rault + Y.Bahout

Figure 8. Universal motor drive: Current and Voltage in the Triac

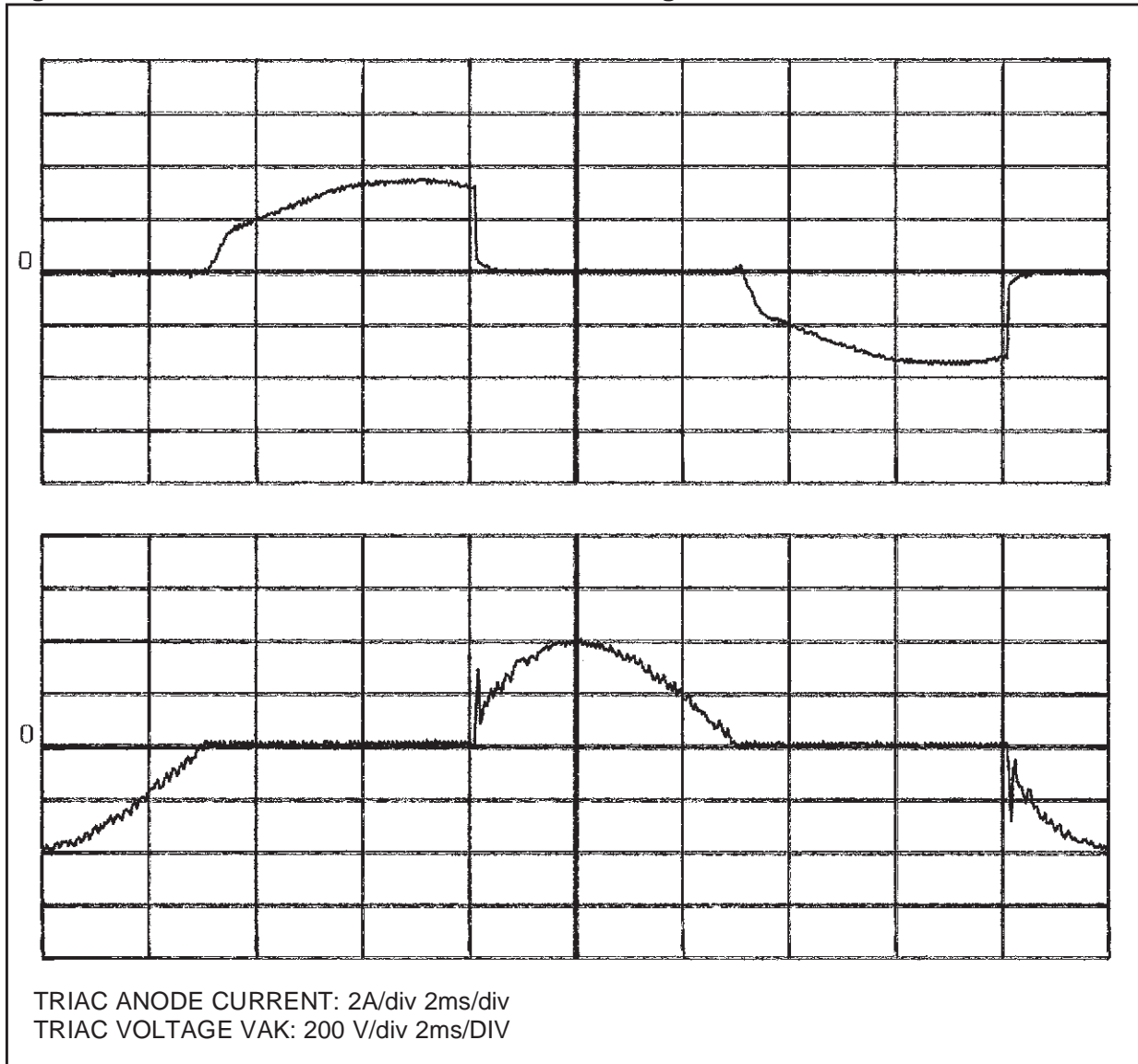

Thyristors and triacs application manual 1989 / STMicroelectronics Microcontroller based universal motor speed control / M.Queyrol

ST62 user manual 1991 / STMicroelectronics

Power control with ST6210MCU and triac / Ph.Rabier + L.Perier

## MCU AND TRIAC ON THE MAINS

**Table 1. Triacs and microcontrollers characteristics**

MICROCONTROLLERS & OUTPUT CAPABILITIES	TRIAC	SENSITIVITY	GATE PARAMETERS	CONNECTION
ST621x SERIES ST622x SERIES $I_{OL}=20mA$ AT $V_{OL}=1.3V$	T & TW SERIES Tx05 SERIES	$I_{GT}=5mA$	$V_G=1.5V$ AT $I_G=10mA$	1 I/O BIT/TRIAC
	S & SW SERIES Tx10 SERIES	$I_{GT}=10mA$	$V_G=1.5V$ AT $I_G=20mA$	1 I/O BIT/TRIAC
	C SERIES	$I_{GT}=25mA$	$V_G=1.5V$ AT $I_G=50mA$	2 I/O BITS IN PARALLEL/TRIAC
	CW SERIES	$I_{GT}=35mA$	$V_G=2V$ AT $I_G=70mA$	3 I/O BITS IN PARALLEL/TRIAC
	B & BW SERIES	$I_{GT}=50mA$	$V_G=2V$ AT $I_G=100mA$	4 I/O BITS IN PARALLEL/TRIAC

THE PRESENT NOTE WHICH IS FOR GUIDANCE ONLY AIMS AT PROVIDING CUSTOMERS WITH INFORMATION REGARDING THEIR PRODUCTS IN ORDER FOR THEM TO SAVE TIME. AS A RESULT, STMICROELECTRONICS SHALL NOT BE HELD LIABLE FOR ANY DIRECT, INDIRECT OR CONSEQUENTIAL DAMAGES WITH RESPECT TO ANY CLAIMS ARISING FROM THE CONTENT OF SUCH A NOTE AND/OR THE USE MADE BY CUSTOMERS OF THE INFORMATION CONTAINED HEREIN IN CONNEXION WITH THEIR PRODUCTS.

Information furnished is believed to be accurate and reliable. However, STMicroelectronics assumes no responsibility for the consequences of use of such information nor for any infringement of patents or other rights of third parties which may result from its use. No license is granted by implication or otherwise under any patent or patent rights of STMicroelectronics. Specifications mentioned in this publication are subject to change without notice. This publication supersedes and replaces all information previously supplied. STMicroelectronics products are not authorized for use as critical components in life support devices or systems without the express written approval of STMicroelectronics.

The ST logo is a registered trademark of STMicroelectronics

©1998 STMicroelectronics - All Rights Reserved.

Purchase of I<sup>2</sup>C Components by STMicroelectronics conveys a license under the Philips I<sup>2</sup>C Patent. Rights to use these components in an I<sup>2</sup>C system is granted provided that the system conforms to the I<sup>2</sup>C Standard Specification as defined by Philips.

STMicroelectronics Group of Companies

Australia - Brazil - Canada - China - France - Germany - Italy - Japan - Korea - Malaysia - Malta - Mexico - Morocco - The Netherlands - Singapore - Spain - Sweden - Switzerland - Taiwan - Thailand - United Kingdom - U.S.A.

<http://www.st.com>



LittleDiode supplies new, hard to find or obsolete electronic components and semiconductors all over the world.

With over two million different components listed you are sure to find the part you need.

Feel free to visit us today at our online store:

**[LittleDiode.com](http://LittleDiode.com)**

Looking forward to providing you with the best possible service.