

AN3890FBS

Capstan Motor Drive IC for VCR

Overview

The AN3890FBS is an IC designed as a VCR capstan motor drive. It is particularly optimum for camera combined VCR.

Features

- Controls the output transistors (external) at low V_{CE} .
- Built-in torque ripple cancellation circuit.
- Overlap drive.
- Provided with predrive output for switching regulator control.
- Output pin electrolytic capacitor unrequired.

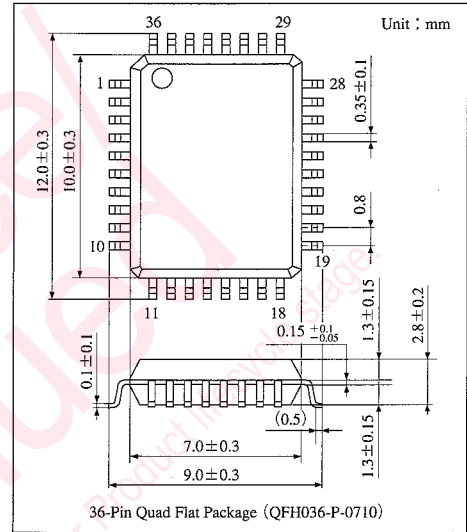

Block Diagram

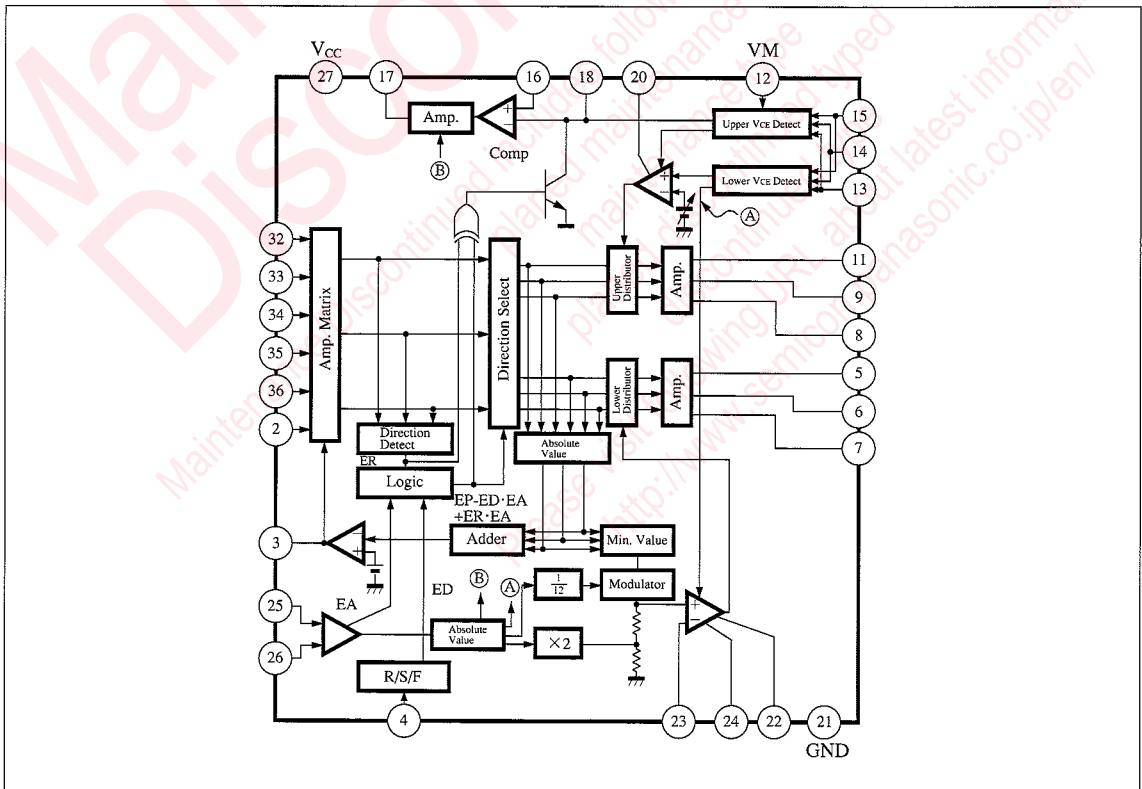

■ Absolute Maximum Ratings (Ta=25°C)

Parameter	Symbol	Rating	Unit	Note
Supply voltage	V _{CC}	6	V	
Power dissipation	P _D	500	mW	
Operating ambient temperature	T _{opr}	-20 to +70	°C	
Storage temperature	T _{stg}	-55 to +125	°C	
Motor supply voltage	V _{I2}	20	V	
Output pin voltage	V _I	20	V	V _I =13,14,15
Pin voltage	V _m	-0.3 to V _{CC}	V	m=2,4,16,24, 25,26,32, 33,34,35,36

■ Recommended Operating Range (Ta=25°C)

Parameter	Symbol	Range
Operating supply voltage range	V _{CC}	4.5V to 5.5V

■ Electrical Characteristics (V_{CC}=5V, Ta=25°C)



Parameter	Symbol	Condition	min	typ	max	Unit
Circuit current	I _{CC}		—	—	15	mA
Torque command ref. voltage	ECR		2	—	3	V
Torque command voltage	EC		0.5	—	4	V
Torque command input current	I _{EC}	EC=ECR=2.5V	-1	—	0	μA
Torque command input offset voltage	EC _{off}		-150	—	150	mV
Torque command dead zone	EC _{DZ}		30	—	150	mV
Output idle voltage	ATC _{idle}		0	—	4	mV
I/O gain	G _{IO}		0.19	0.24	0.28	times
Output max. voltage	ATC _{max}		0.3	—	—	V
Forward command voltage	ED _F		—	—	0.9	V
Stop command voltage	ED _S		1.3	—	3.1	V
Reverse command voltage	ED _R		3.5	—	—	V
Hall element input allowable voltage	H _{in}		1.1	—	3.5	V
Hall element input conversion offset	H _{offset}		-8	—	8	mV
Lower output voltage (1)	VN (1)	ATC=66mV	0.25	0.37	0.55	V
Lower output voltage (2)	VN (2)	EC=0.5V	—	—	1.2	V
TL-CS offset	TL _{offset}	TL=0.2V	0	7	15	mV
Ripple cancellation rate	α	V _{ATC} =66mV	6	10.5	15	%
Upper drive max. current	I _{MP}		15	—	—	mA
Lower drive max. current	I _{MN}		—	—	-15	mA
Switching power supply control output operating point	PCS	PCS=1.7V at V _M =6V. Value of V _M -MI Times	0.25	0.4	0.55	V
Switching power supply control output gain	G _{PCS}	V _M =6V	6.5	9	11	times
Output drive max. current for switching power supply	I _{sw}	EC=0.5V	8	—	—	mA
Output rise time for switching power supply	t _{on}		—	—	1	μs
Output fall time for switching power supply	t _{off}		—	—	1	μs
Switching power supply comparator input offset	ΔV _{FC}		-10	—	10	mV
Switching power supply comparator input current	I _{FC}	FC=1.7V	-10	—	0	μA

ICs for
Video
Camera

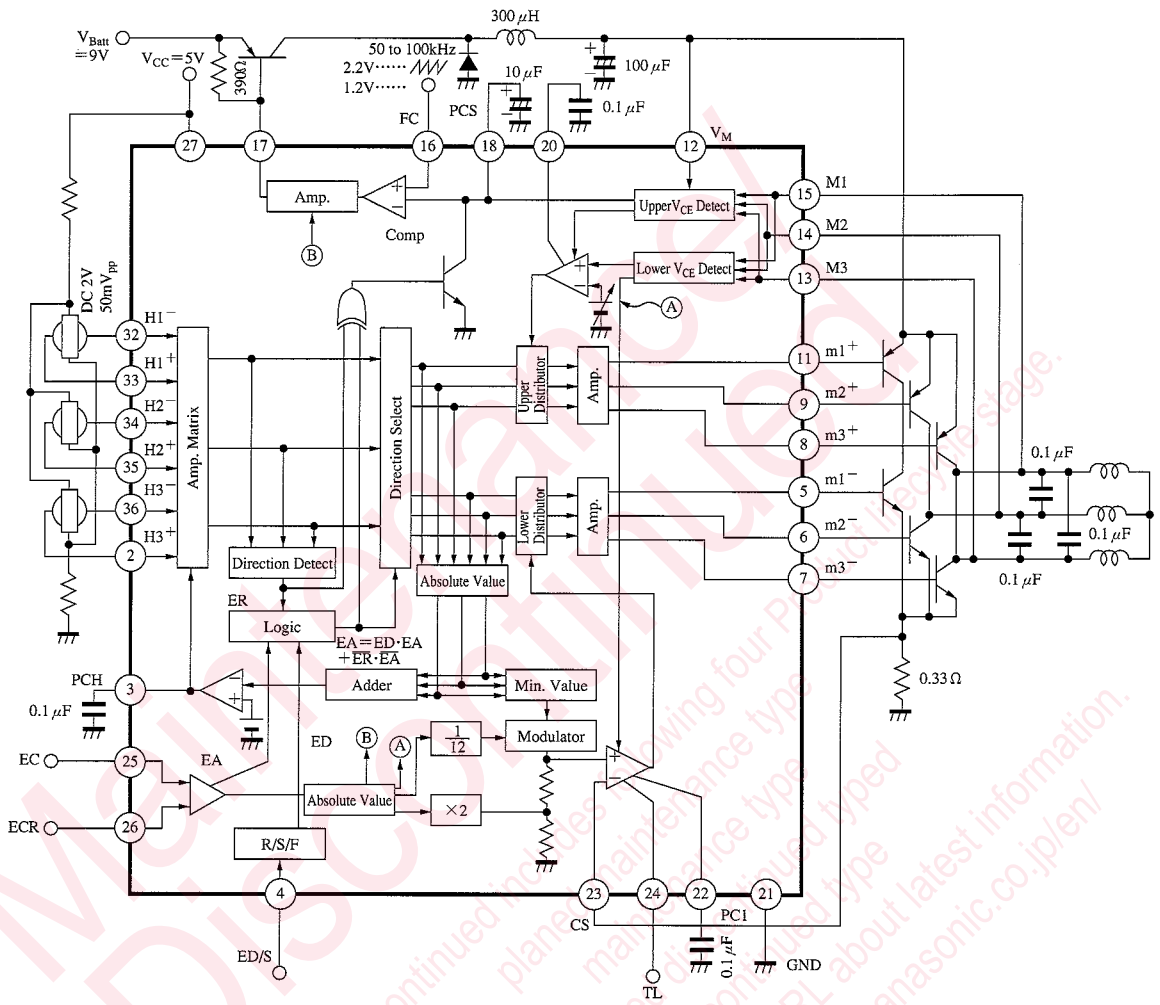
■ Application Circuit

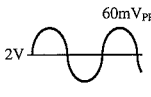
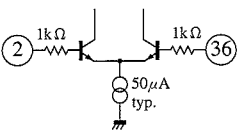

■ Pin Descriptions

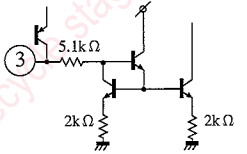
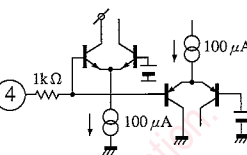
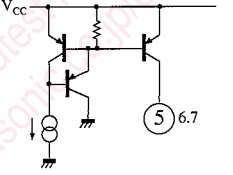
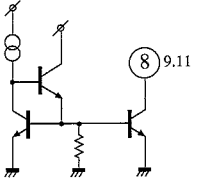
Pin No.	Pin name	Typ. waveform	Description	I/O impedance	Equivalent circuit
1	NC	_____	_____	—	_____
2	H ₃ ⁺ Hall element input		Inputs signal for the Hall element of the motor.	—	
3	PCH Hall amp. phase compensation		AGC loop phase-compensation pin of the Hall amplifier	—	
4	ED/S direction command input	_____	Gives motor rotary direction or stop command with 3-valued input.	—	
5	m ₂ ⁻ lower predrive output 1	_____	Pre-drive output for output transistor of the sink side (lower side)	—	
6	m ₂ ⁻ lower predrive output 2	_____			
7	m ₃ ⁻ lower predrive output 3	_____			
8	m ₃ ⁺ upper predrive output 3	_____	Pre-drive output for output transistor of the source side	—	
9	m ₂ ⁺ upper predrive output 2	_____			
11	m ₁ ⁺ upper predrive output 1	_____			
10	NC	_____	_____	—	_____
12	V _M motor power pin	_____	Motor power input pin	—	_____

ICs for Video Camera

■ Pin Descriptions (cont.)

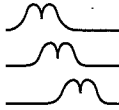
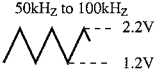
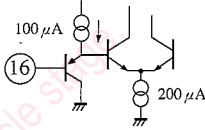
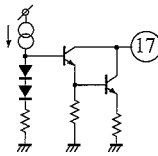
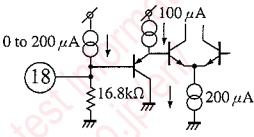
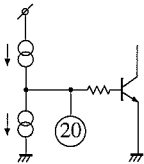
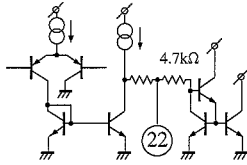
Pin No.	Pin name	Typ. waveform	Description	I/O impedance	Equivalent circuit
13 14 15	M3 motor coil pin 3 M2 motor coil pin 2 M1 motor coil pin 1		Connect to the motor coil.	—	—
16	FC switching power triangular wave input pin		Inputs switching power supply control triangular wave from external.	—	
17	SW switching power output	—	Power transistor pre-drive output for switching power supply	—	
18	PCS switching power control output	—	Outputs a voltage proportional to V_{CE} of the output on the source side. It also serves as a phase compensation pin for the switching power supply loop.	16.8k Ω	
19	NC	—	NC	—	—
20	PCV voltage feedback system phase compensation	—	Phase compensation pin of the control system for the output transistor on the source side	—	
21	GND pin	—	Ground pin	—	—
22	PCI current feedback phase compensation	—	Phase compensation pin of the control system for the output transistor on the sink side.	—	

■ Pin Descriptions (cont.)

Pin No.	Pin name	Typ. waveform	Description	I/O impedance	Equivalent circuit
23	CS current detection pin	_____	Inputs the value detected by a current detection resistor.	—	
24	TL torque limit pin	_____	Inputs an output current limit value.	—	
25	EC torque command input pin	_____	Inputs a torque command.	—	
26	ECR torque command ref. input pin	_____	Inputs a torque command ref. voltage.	—	
27	V _{CC} power pin	_____	Inputs the supply voltage.	—	_____
28, 29 30, 31	NC	_____	NC	—	_____
32 33 34 35 36	H ₁ ⁻ Hall element input H ₁ ⁺ Hall element input H ₂ ⁺ Hall element input H ₂ ⁻ Hall element input H ₃ ⁻ Hall element input		Inputs a signal for the Hall elements of the motor.	—	

ICs for Video Camera

Supplementary Explanation

● Hall Input and Output Current Phases for AN3890FBS

ED/S=0V EC<ECR

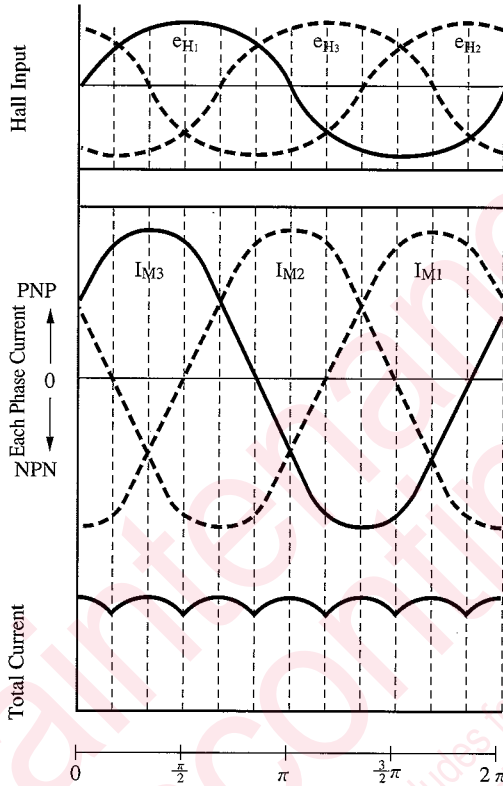

• Torque Direction Setting Logic

The direction of generated torque is determined by the following information.

- Information from the rotary direction detection circuit : \overline{ER}
High : $H_1 \rightarrow H_3 \rightarrow H_2$
- Brake information from the torque command circuit : \overline{EA}
High : $ECR > EC$

• Rotary direction command : \overline{ED}

High : $H_1 \rightarrow H_3 \rightarrow H_2$
 $H_1 \rightarrow H_3 \rightarrow H_2$ (forward rotation) at $ED/S=0V$

• Direction of generated torque : \overline{EP}

High : Generates a torque rotating in the direction of $H_1 \rightarrow H_3 \rightarrow H_2$

EP is determined as follows, depending on ER ,

EA , or ED

$$EP = ED \cdot EA + \overline{EA} \cdot \overline{EA}$$

	\overline{EA}	EA		\overline{EA}
ED	H	H	H	L
\overline{ED}	H	L	L	L
	\overline{ER}		ER	

Torque Direction Setting Logic Carnot's Diagram

Request for your special attention and precautions in using the technical information and semiconductors described in this book

- (1) If any of the products or technical information described in this book is to be exported or provided to non-residents, the laws and regulations of the exporting country, especially, those with regard to security export control, must be observed.
- (2) The technical information described in this book is intended only to show the main characteristics and application circuit examples of the products. No license is granted in and to any intellectual property right or other right owned by Panasonic Corporation or any other company. Therefore, no responsibility is assumed by our company as to the infringement upon any such right owned by any other company which may arise as a result of the use of technical information described in this book.
- (3) The products described in this book are intended to be used for standard applications or general electronic equipment (such as office equipment, communications equipment, measuring instruments and household appliances).
Consult our sales staff in advance for information on the following applications:
 - Special applications (such as for airplanes, aerospace, automobiles, traffic control equipment, combustion equipment, life support systems and safety devices) in which exceptional quality and reliability are required, or if the failure or malfunction of the products may directly jeopardize life or harm the human body.
 - Any applications other than the standard applications intended.
- (4) The products and product specifications described in this book are subject to change without notice for modification and/or improvement. At the final stage of your design, purchasing, or use of the products, therefore, ask for the most up-to-date Product Standards in advance to make sure that the latest specifications satisfy your requirements.
- (5) When designing your equipment, comply with the range of absolute maximum rating and the guaranteed operating conditions (operating power supply voltage and operating environment etc.). Especially, please be careful not to exceed the range of absolute maximum rating on the transient state, such as power-on, power-off and mode-switching. Otherwise, we will not be liable for any defect which may arise later in your equipment.
 - Even when the products are used within the guaranteed values, take into the consideration of incidence of break down and failure mode, possible to occur to semiconductor products. Measures on the systems such as redundant design, arresting the spread of fire or preventing glitch are recommended in order to prevent physical injury, fire, social damages, for example, by using the products.
- (6) Comply with the instructions for use in order to prevent breakdown and characteristics change due to external factors (ESD, EOS, thermal stress and mechanical stress) at the time of handling, mounting or at customer's process. When using products for which damp-proof packing is required, satisfy the conditions, such as shelf life and the elapsed time since first opening the packages.
- (7) This book may be not reprinted or reproduced whether wholly or partially, without the prior written permission of our company.



LittleDiode supplies new, hard to find or obsolete electronic components and semiconductors all over the world.

With over two million different components listed you are sure to find the part you need.

Feel free to visit us today at our online store:

LittleDiode.com

Looking forward to providing you with the best possible service.