



VIPower: 48W POWER SUPPLY USING VIPer100A

Vee Shing Wong

INTRODUCTION

This application note describes a wide-range input off-line mode single switch Flyback power supply using VIPer100A. The VIPer100A is a current mode PWM with a high voltage avalanche rugged Vertical Power MOSFET on the same silicon.

1. SCHEMATIC

VIPer100A are typically used in off-line power supplies with a secondary power capability of 50W in wide range condition and 100W in single range or with doubler configuration. It utilizes current mode control and as such, the inherent input voltage feedforward characteristic of this control ensures excellent open loop D.C. and dynamic line regulation. It can be used for primary or secondary regulation, has a burst mode in stand-by for Blue Angel operation, adjustable switching frequency of up to 200kHz, an adjustable current limitation circuit, and thermal protection.

This off-line wide range power supply operates at a switching frequency of 100kHz and is set up for secondary regulation with an optocoupler. The output can deliver 24V at 2.0A and it operates in the discontinuous mode (See Figure 1).

The circuit contains an input fuse (F2), an inrush thermistor, EMI filtering (C1, L1, and CX2), clamp circuit (R2 and C3), and a snubber circuit for the diode D1 (R3 and C4). R5 and C6 set the operating frequency whereas R8 and C15 provide extra immunity for lightning strike. The secondary regulation is provided by U2 and U3, the optocoupler and TL431 respectively. For output filtering, the components used are the output capacitors C9, C10, and C11 as well as the inductor, L4.

Table 1: Operating Conditions

Parameter	Results
Input Voltage Range	90 to 264V _{AC}
Input Frequency Range	50/60Hz
Output Voltage	24V
Output Power	48W
Efficiency	82% @ 115V _{AC} and 83% @ 230V _{AC}
Output Ripple Voltage	20mV _{P-P} Max
Line Regulation	+/- 0.0%
Load Regulation	+/- 0.14%
EMI	EN55022 Class B

AN1521 - APPLICATION NOTE

Figure 1: Schematic Diagram

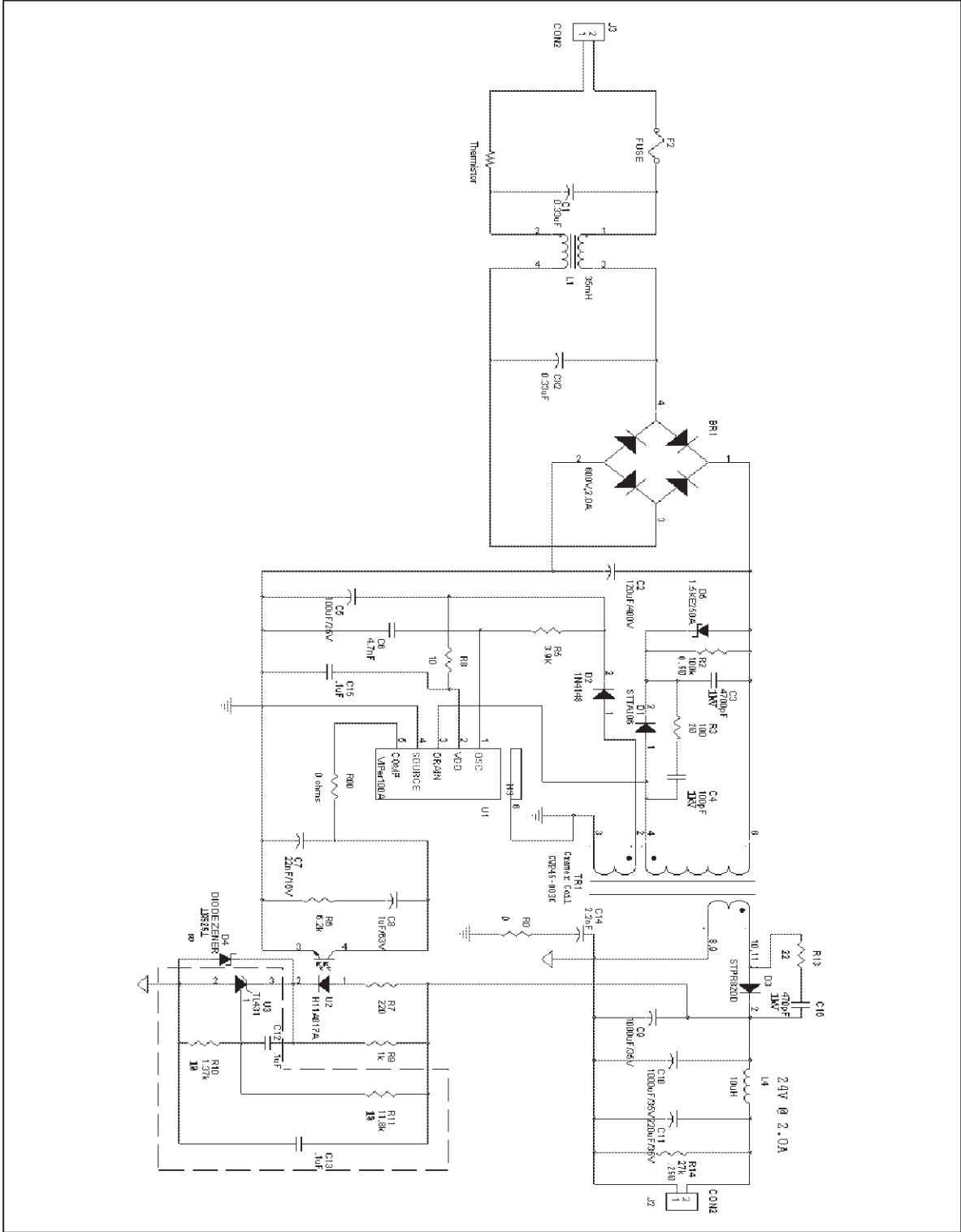

Figure 2: Board Layout

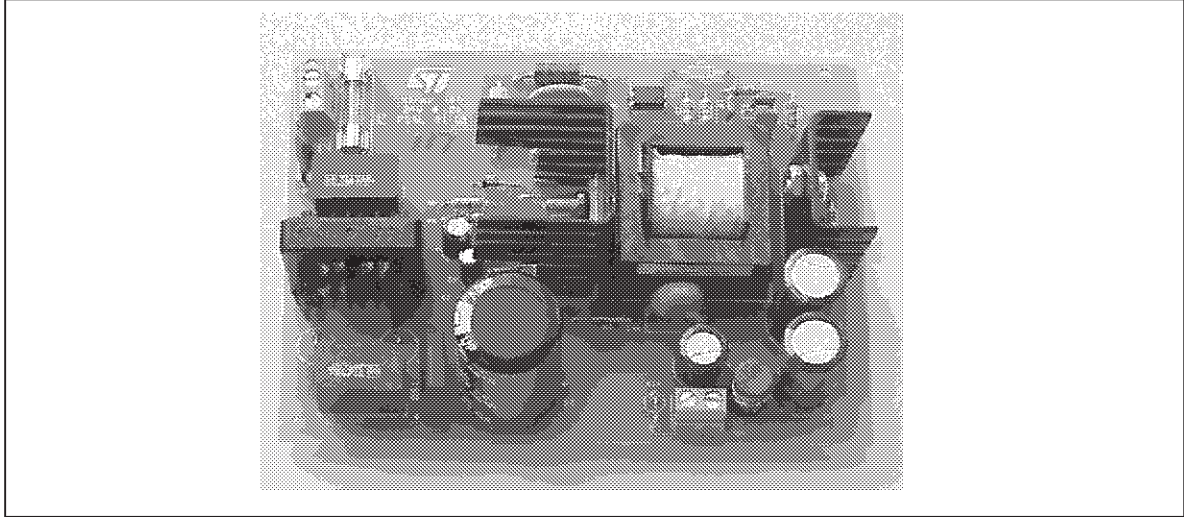

Figure 3: PC Board Top Legend (not in scale)

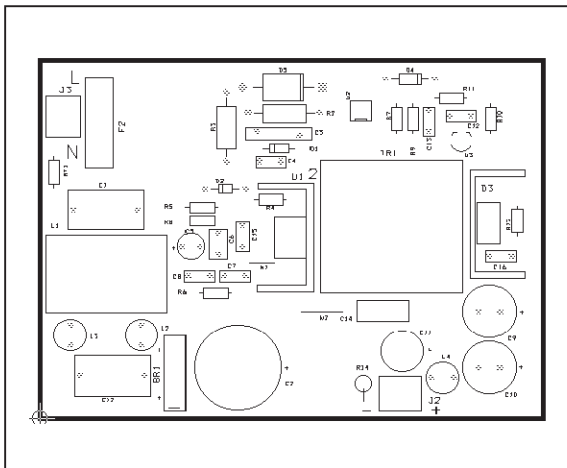
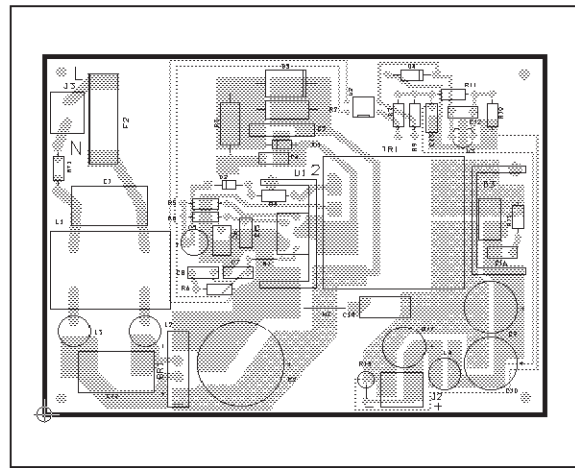

Figure 4: PC Board Top and Bottom Foil



2. TRANSFORMER SPECIFICATION

Primary Inductance: $200\mu\text{H} \pm 10\%$

Primary Leakage Inductance: $5.4\mu\text{H}$ typical

When the VIPer100A (U1) is on, energy is stored in the primary winding of transformer (4-6), TR1. This energy is transferred to the auxiliary winding (2-3), and to the output (12,10-9,7) when the VIPer100A is off. The auxiliary winding provides the bias voltage for the VIPer100A at pin 2 (Vdd).

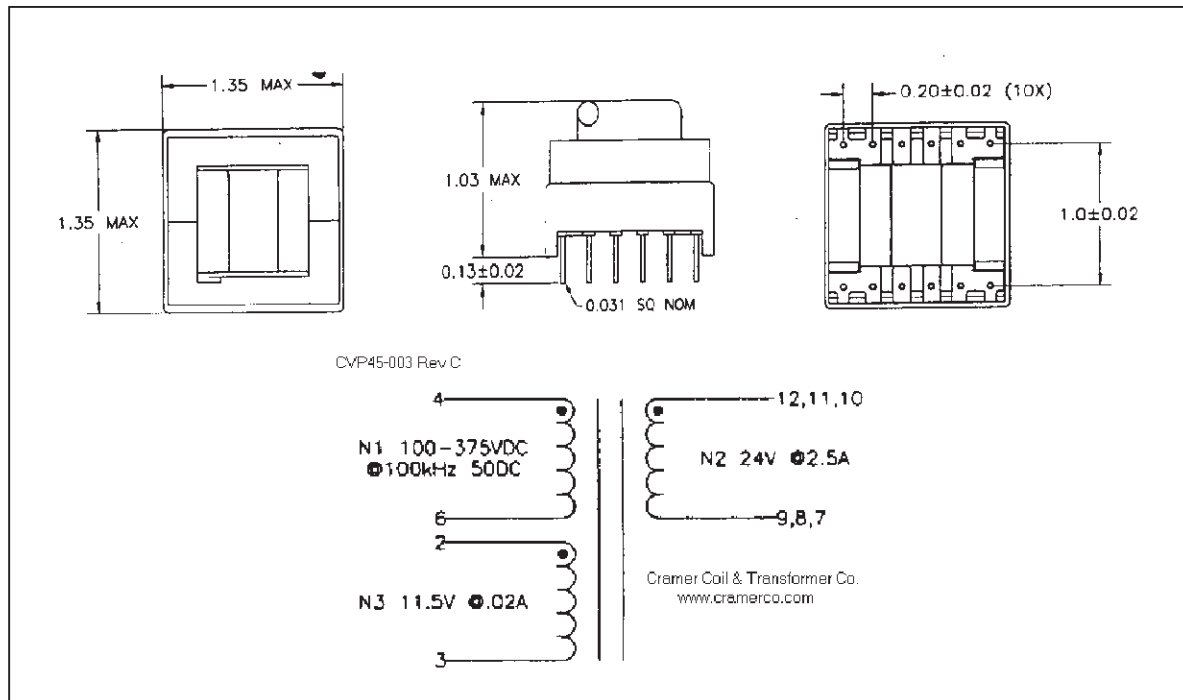
MECHANICAL DRAWINGS:**3. LAYOUT CONSIDERATIONS**

To improve the performance of the switching power supply, the following requirements need to be met:

- Minimize power loops: Switched current paths must present the smallest inner loop area possible. This prevents radiated EMC noises, conducted EMC noises by magnetic coupling, and provides a better efficiency by eliminating parasitic inductances, especially on the secondary side.
- Use of different tracks for low level signals and power signals: Instabilities occur due to interferences created by the mixing of signal and power. It may also cause anomalous behavior of the device in case of violent power surges.

Adequate clearance is needed between high and low voltage circuits to meet safety agencies' requirements.

4. WAVEFORM

Figure 5 shows a typical turn on waveform of the drain source voltage, and drain current for an input voltage of 115VAC at maximum load current of 2A.

5. THERMAL CONSIDERATIONS

At room ambient of 24.6°C, the VIPer100A tab temperature reached 54.3°C at 115VAC input with the maximum load of 2A. A heatsink is used on the demoboard for VIPer100A, and it requires an insulation mounting kit to separate the VIPer100A drain from the heatsink.

Temperature measurements may vary depending on final application.

6. COST CONSIDERATIONS

A zener diode, 1N5251, can be used to replace the following components for a cost-reduced design: U3 (TL431), C12, R10, R11, and C13.

Figure 5: Drain Source Voltage and Drain Current

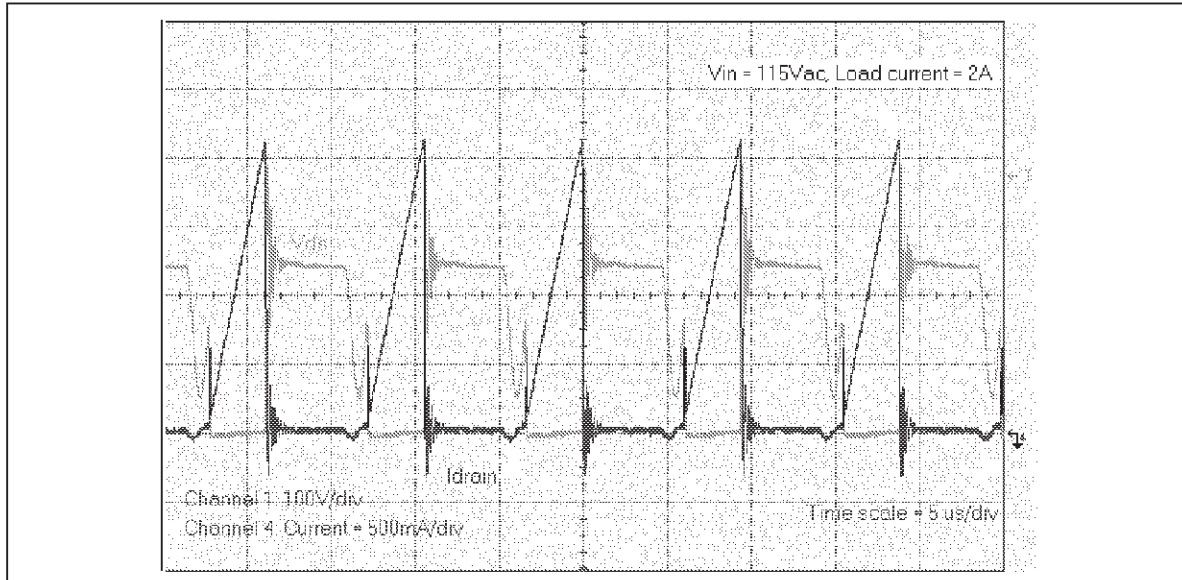

7. OUTPUT RIPPLE

A voltage ripple of 10mVPP is measured at 2A maximum load. This low ripple is obtained using the low pass filter configuration of L4 and C11.

8. EMI CONSIDERATION

This unit passed EN55022 Class B. Figure 6 shows the EN55022 Class B EMI plot.

Figure 6: EMI Results

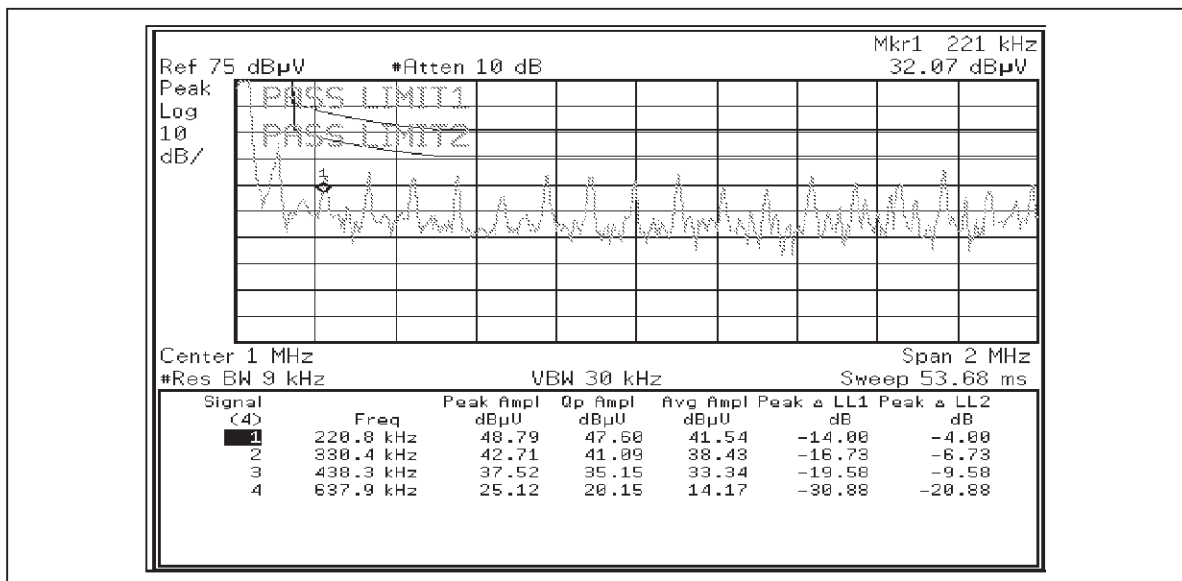

AN1521 - APPLICATION NOTE

9. TRANSIENT RESPONSE

The output current is stepped from 1A to 2A, with a 50% duty cycle at a line input of 115VAC. The result is 234mV or 1% dynamic regulation with a settling time of 250 ms. This is shown in Figure 7.

10. BLUE ANGEL

This demo board meets the new German "Blue Angel" Norm with less than 1W total power consumption for the system when working in stand-by. The unit will be operating at burst mode when the output load is reduced to zero. The output voltage remains regulated around the normal level, with a low frequency ripple corresponding to the burst mode. The normal operation resumes automatically when the power gets back to higher levels than PSTBY.

The total power consumption in stand-by mode is 0.59W at 115VAC input and 0.70W at 230VAC input.

Figure 7: Transient Response

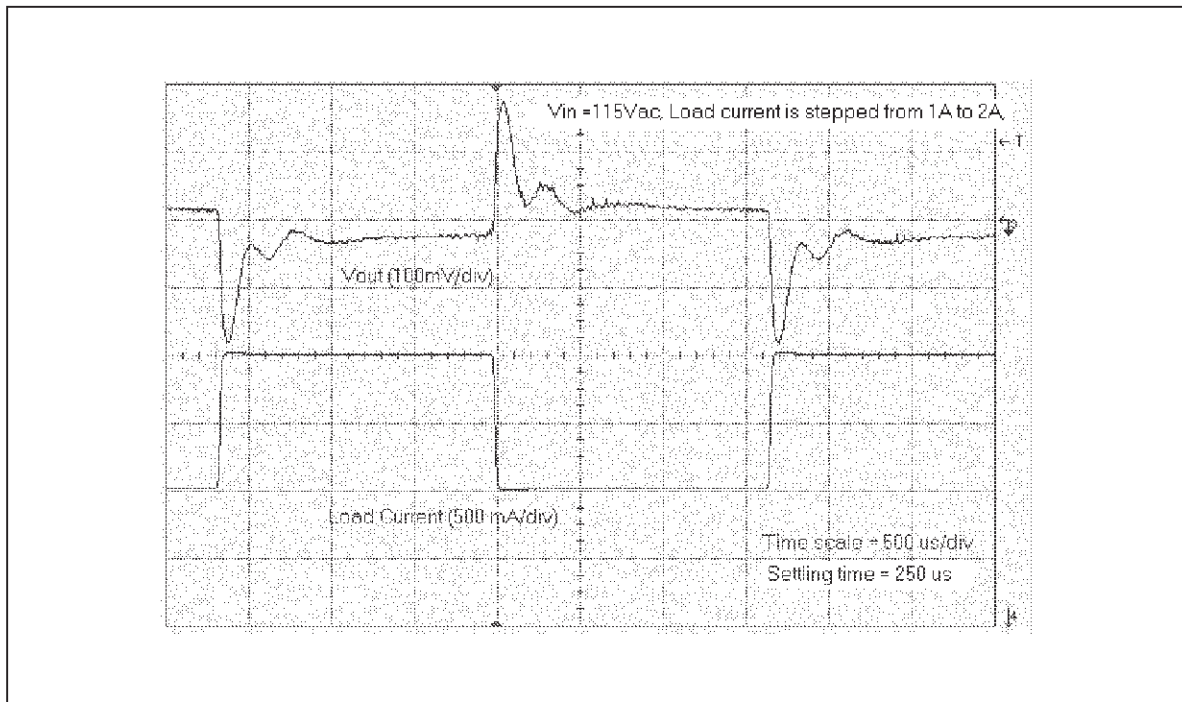

11. EFFICIENCY

The efficiency measurements are taken at input voltages of 115VAC and 230VAC. This demo board has an efficiency of 82% at 115VAC to 83% at 230 VAC input with 2.0A load current. This value varies depending on the final application. Figure 8 shows the efficiency values versus output current at input voltages of 115VAC and 230VAC.

12. CONCLUSION

The VIPer100A demo board is designed as a discontinuous flyback regulator. It delivers 48W for a wide voltage range. Its features include excellent regulation, short circuit protection, current limiting, it meets EN55022 Class B EMI regulation and Blue Angel.

Figure 8: Efficiency vs. Output Current at 115VAC and 230VAC

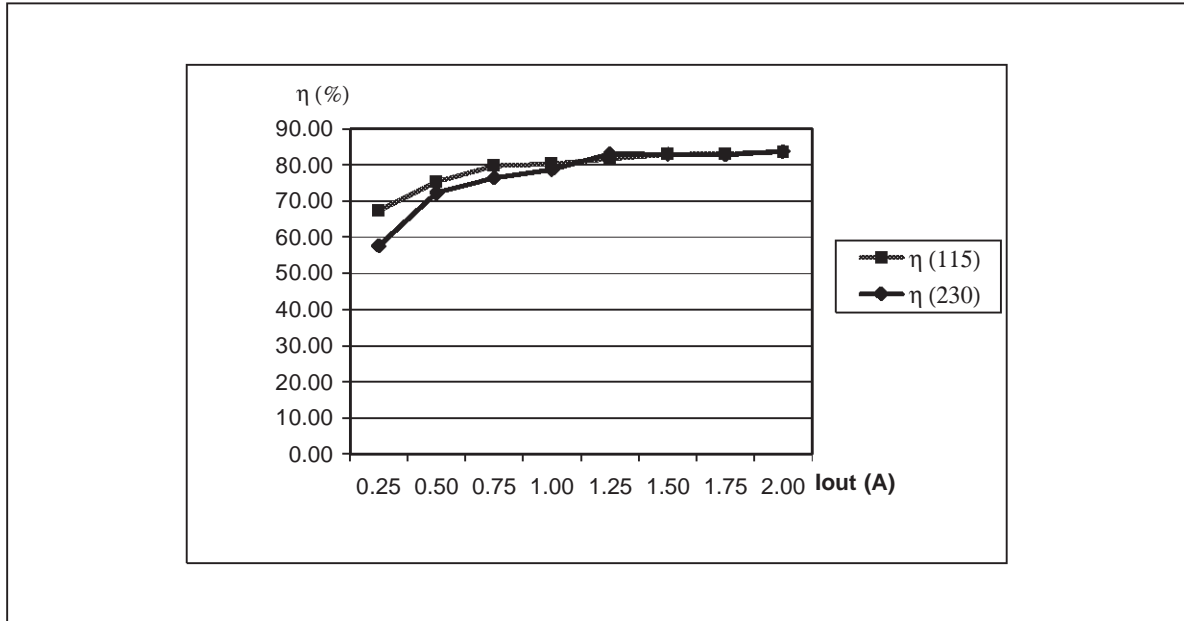

AN1521 - APPLICATION NOTE

Table 2: Components List

Quantity	Reference	Value or description	Part Number
1	BR1	600V,2.0A	2KBP06M
2	C1,CX2	0.33uF/250V	P10733
1	C2	120uF/400V	P6142
1	C3	4700pF 1kV	
1	C4	100pF 1kV	
1	C5	100uF/35V	P1180
1	C6	4.7nF	
1	C7	22nF 16V	
1	C8	1uF/63V	
2	C9, C10	1000uF/35V	P10305
1	C11	220uF/35V	P10305
3	C12, C13, C15	.1uF	P10296
1	C14	2.2nF	
1	C16	470pF 1kV	
1	D1	STTA106	STMicroelectronics STTA106
1	D2	1N4148	1N4148DICT
1	D3	STPR820D	STMicroelectronics STPR820D
1	D4	DIODE ZENER, 1N5251 (opt)	Not Used
1	D5	1.5KE250A	STMicroelectronics 1.5KE250A
1	F2	FUSE/250V	FUSE
1	L1	35mH Line Filter	
1	L4	10uH	Coilcraft DC1012-103
2	R00, R0	0 ohms	Jumper wire
1	R2	100K 0.5W	
1	R3	100 ohms 2W	
1	R4	0 ohms	Jumper wire
1	R5	3.9K	
1	R6	6.2K	
1	R7	220 ohms	
1	R8	10 ohms	
1	R9	1k	
1	R10	1.37K 1%	
1	R11	11.8K 1%	
1	R13	22 ohms	
1	R14	27k 0.25W	
1	RT1	Thermistor	
1	TR1	CVP 45-003 Rev C	Cramer Coil & Transformer
1	U1	VIPer100A	STMicroelectronics VIPer100A
1	U2	H11A817A	H11A817AQT
1	U3	TL431	STMicroelectronics TL431CLP
2	J2, J3	CON2	Connectors

Information furnished is believed to be accurate and reliable. However, STMicroelectronics assumes no responsibility for the consequences of use of such information nor for any infringement of patents or other rights of third parties which may result from its use. No license is granted by implication or otherwise under any patent or patent rights of STMicroelectronics. Specifications mentioned in this publication are subject to change without notice. This publication supersedes and replaces all information previously supplied. STMicroelectronics products are not authorized for use as critical components in life support devices or systems without express written approval of STMicroelectronics.
The ST logo is a trademark of STMicroelectronics

© 2002 STMicroelectronics - Printed in ITALY- All Rights Reserved.

STMicroelectronics GROUP OF COMPANIES

Australia - Brazil - Canada - China - Finland - France - Germany - Hong Kong - India - Israel - Italy - Japan - Malaysia -
Malta - Morocco - Singapore - Spain - Sweden - Switzerland - United Kingdom - U.S.A.

<http://www.st.com>





LittleDiode supplies new, hard to find or obsolete electronic components and semiconductors all over the world.

With over two million different components listed you are sure to find the part you need.

Feel free to visit us today at our online store:

LittleDiode.com

Looking forward to providing you with the best possible service.