



**DESIGNING A THREE PHASE AC INVERTER CONTROL &
INTERFACE BOARD WITH THE ST92141 MCU**

By Motor Control Competence Center

INTRODUCTION

This application note describes a Three Phase AC Inverter control board capable of driving discrete IGBTs directly. The board edge connections allow it to be directly plugged into the Power Board next to the power switches. This particular system split gives several advantages:

- Improves the compactness and modularity of the whole system
- Keeps the power away from signals and reduces parasitic coupling and noise sensitivity
- Makes the power stage layout easier as well as compliance to norms
- Makes the system design faster and future evolution easier

The board features a powerful microcontroller and all the circuits needed to interface with the power switches and the environment. A large C software library allows you to design an AC motor control application quickly and easily.

Table of Contents

INTRODUCTION	1
1 CONTROL BOARD FEATURES	3
2 ABSOLUTE MAXIMUM RATINGS	3
3 DC ELECTRICAL CHARACTERISTICS	4
4 AC ELECTRICAL CHARACTERISTICS	4
5 ST92141 PLATFORM SCHEMATIC	5
6 ST92141-PLATFORM MECHANICAL DATA	6
7 CONNECTION DESCRIPTION	7
8 TYPICAL APPLICATION: AC MOTOR DRIVE	8
9 SYSTEM VIEWS	10
10 WASHER MOTOR DRIVE DEMONSTRATION SOFTWARE	11
10.1 ST92141 SOFTWARE LIBRARY	11
10.2 ST92141 DEVELOPMENT TOOLS	11
10.3 HOW TO RUN THE SOFTWARE	12
10.3.1 Wash mode 1	12
10.3.2 Wash mode 2	12
10.3.3 Spinning mode	13
10.4 FUNCTIONAL DESCRIPTION	14
10.4.1 Soft Start	14
10.4.2 Ramp-up	15
10.4.3 Sustain speed	15
10.4.4 Decrease speed	16
10.4.5 Motor stop	16
10.4.6 Voltage limitation	16
10.4.7 Slip regulation	16
10.4.8 Speed measurement protection / locked rotor	16
10.4.9 Unbalancement measurement	16
10.4.10 Heatsink over-temperature	16
10.4.11 Thermal monitoring	17
10.4.12 DC bus voltage supervision	17
10.4.13 Input power supervision	17
10.4.14 Motor over-current	18
10.4.15 Watchdogs (main watchdog and peripheral watchdogs)	18
10.5 FUNCTION LIST	19

1 CONTROL BOARD FEATURES

- Three phase AC inverter control & interfacing
- Direct plug-in to Power Board
- 600V maximum line voltage rating
- Thermal monitoring and protection via external sensor
- Centralized instantaneous over-current protections
- Centralized average over-current protection
- Low side & high side driver under-voltage protection
- Switching frequency from 1kHz to 20kHz
- Up to eight general purpose digital I/Os with pull-ups/pull-downs and filtering
- Up to four general purpose A/D inputs
- Wide speed range tachometer input with interfacing
- Hardware SPI interface
- Software SCI or I2C interfacing capability
- EEPROM data storage capability
- Comparator input for external protection
- 400mA sourcing & 650 mA sinking current capability
- Features ST92T141K4M6, L6386D, LM358D, M95040

2 ABSOLUTE MAXIMUM RATINGS

Symbol	Parameter	Value	Unit
V_{line}	DC BUS voltage	-0.3 to +600	V
V_{15}	15V DC supply voltage	-0.3 to +18	V
V_{DD}	5V DC supply voltage	-0.3 to +6.5	V
AV_{DD}	A/D converter analog reference	Up to $V_{DD} + 0.3$	V
V_{IN}	Input voltage (digital I/O pins)	-0.3 to $V_{DD} + 0.3$	V
V_{AIN}	Analog input voltage	Ground to AV_{DD}	V
dV_{out}/dt	Allowed output slew rate	50	V/nsec.
V_{cin}	Comparator input voltage	-0.3 to $V_{15} + 0.3$	V
T_{stg}	Storage temperature	-40 to +150	C
T_{cop}	Operating Temperature	-40 to +85	C

3 DC ELECTRICAL CHARACTERISTICS

($T_{amb} = 25^{\circ}\text{C}$ unless otherwise specified)

Symbol	Parameter	Test Conditions	Min	Typ	Max	Unit
V_i	Logic input voltage threshold J10,11,13,15,16,19,20,22,24,25,27,28	$V_{DD} = 5\text{V}$ low high	3.5		0.8	V
I_i	Logic input current J10,11,13,15,16,19,20,22,24,25,27,28	No pull-up, no pull-down	-	-	100	μA
V_{line}	DC BUS voltage		-	-	580	V
V_{15}	15V DC supply voltage		13	15	17	V
V_{DD}	5V DC supply voltage		4.5	5	5.5	V
V_{ccth1}	Driver Under Voltage turn-on threshold		10.7	-	12.9	V
V_{ccth2}	Driver UV turn-off threshold		8.8	-	10.7	V
V_{cchys}	Driver UV hysteresis			2		V
V_{io}	Comparator input offset voltage		-10	-	+10	mV
I_{io}	Comparator input bias current			0.2		μA
V_{ref}	Comparator reference voltage		0.460	0.5	0.540	V
I_{so}	High/low side driver short-circuit source current		300	400		mA
I_{si}	High/low side driver short-circuit sink current		500	650		mA
V_{LVDR}	Reset release threshold				4.2	V
V_{LVDF}	Reset generation threshold		3.4			V

4 AC ELECTRICAL CHARACTERISTICS

($T_{amb} = 25^{\circ}\text{C}$ unless otherwise specified)

Symbol	Parameter	Test Conditions	Min	Typ	Max	Unit
I_{DDRUN}	Board run mode bias current		-	60	-	mA
I_{DDWFI}	Board WFI mode bias current		-	25	-	mA
I_{DDLWFI}	Board low Power WFI mode bias current		-	12	-	mA
Freq	Recommended switching frequency		1	-	20	kHz

DESIGNING A THREE PHASE AC INVERTER CONTROL & INTERFACING BOARD...

5 ST92141 PLATFORM SCHEMATIC

The values given are typical values only, and must be adapted to your specific application.

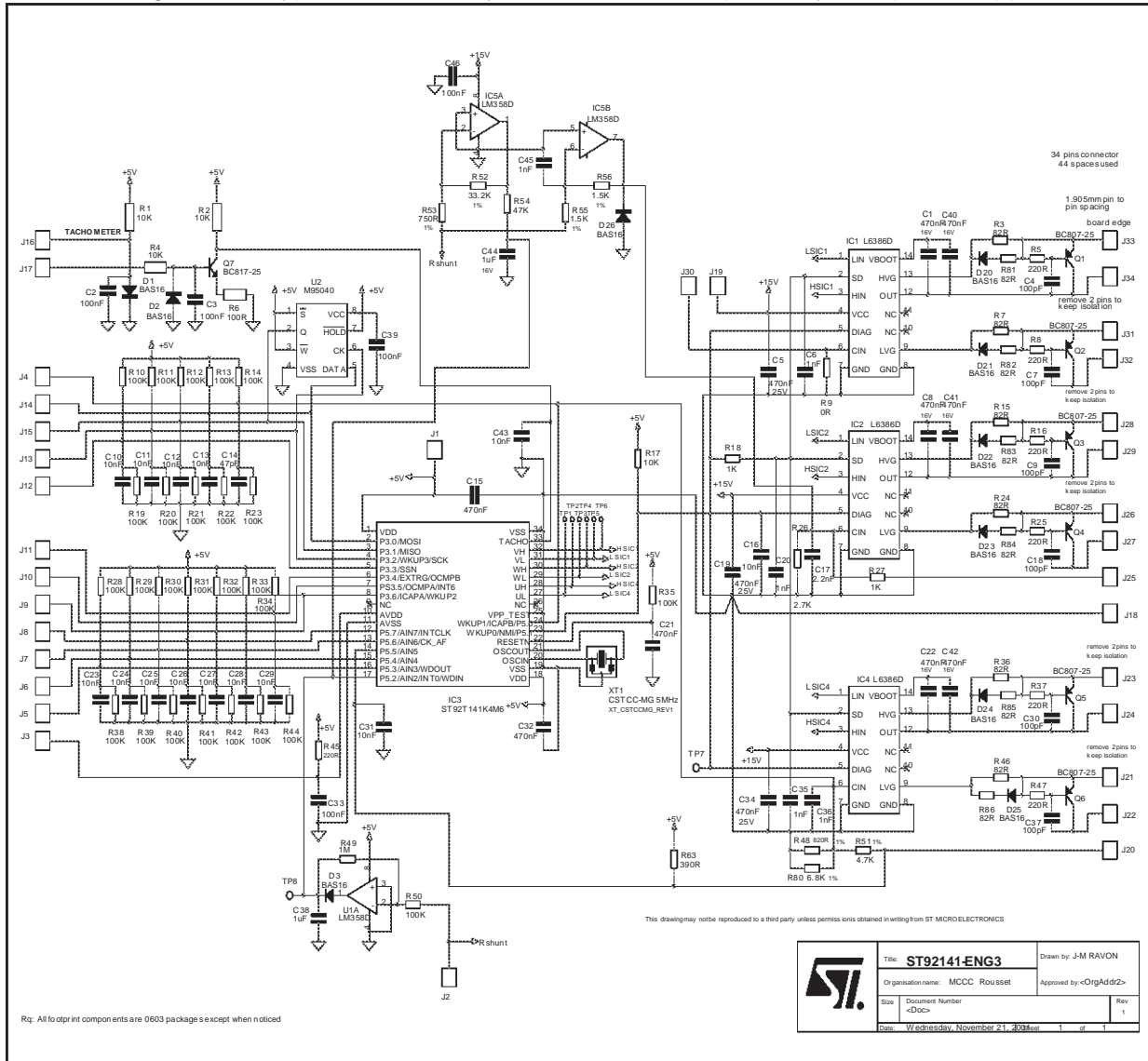

This circuit can be used in various AC motor drive applications. This explains why there is some redundancy. The board can be populated in different ways depending on the application environment.

For example:

- The gate drive circuit can be simplified depending on power management and EMC optimization
- The EEPROM memory is not needed if register data retention is not required
- One interfacing IC can be omitted for single phase control

6 ST92141-PLATFORM MECHANICAL DATA

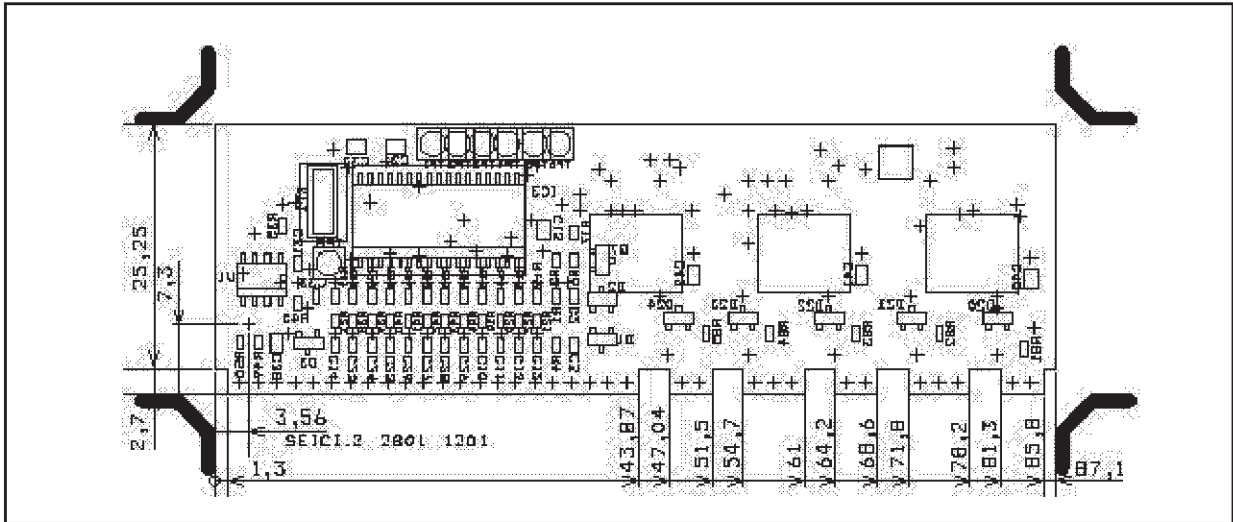

CONTROL BOARD LAYOUT (Orcad files available)

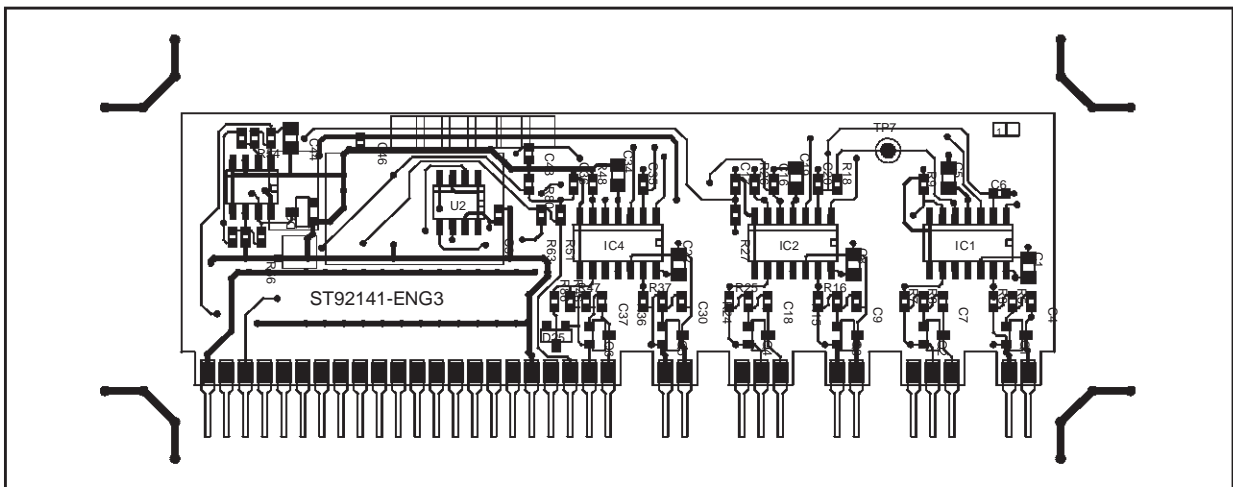
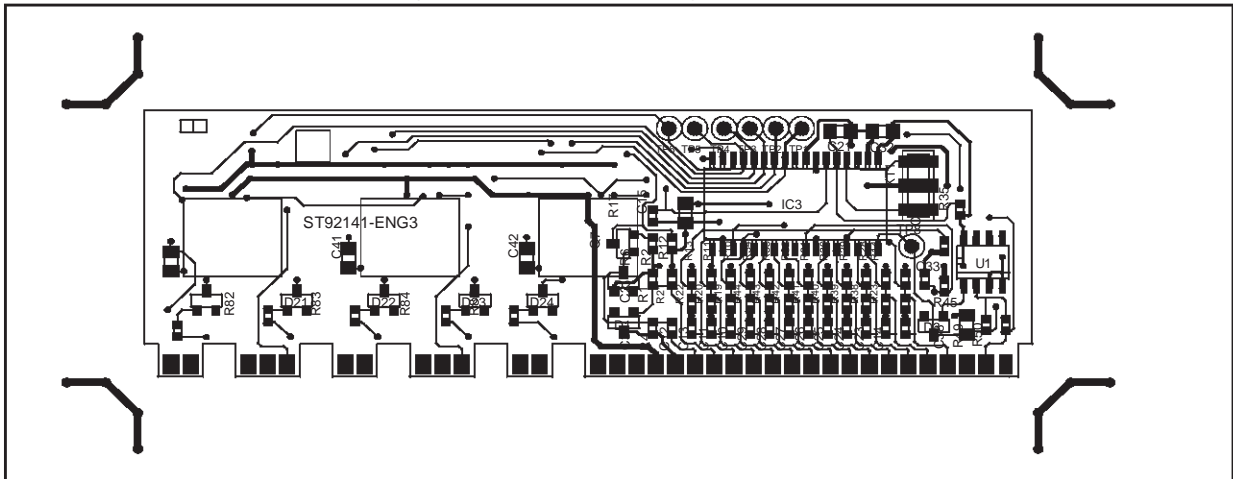

7 CONNECTION DESCRIPTION

Name	Position	Function	Comments
UHVG	J33	Phase U high side gate drive	
ULVG	J31	Phase U low side gate drive	
VHVG	J28	Phase V high side gate drive	
VLVG	J26	Phase V low side gate drive	
WHVG	J23	Phase W high side gate drive	
WLVG	J21	Phase W low side gate drive	
OUTU	J34	Phase U high side emitter	
OUTV	J29	Phase V high side emitter	
OUTW	J24	Phase W high side emitter	
ULem	J32	Phase U low side emitter	
VLem	J27	Phase V low side emitter	
WLem	J22	Phase W low side emitter	
Pgrd	J18	Power Ground	
Isense	J25	Instantaneous current sense input	
Tsense	J20	Thermal sensor input	
V15	J19	15V supply voltage	
VDD	J1	5V supply voltage	
Comp	J30	Comparator input	
Rshunt	J2	Average current sense input	
Tacho1	J16	Tacho meter input	
Tacho2	J17	Tacho meter input	
P5.0	J4	Digital I/O or timer input	
P3.0	J14	Digital I/O or SPI	
P3.1	J15	Digital I/O or SPI	
P3.2	J13	Digital I/O or SPI	
P3.3	J12	Digital I/O or SPI	
P3.4	J11	Digital I/O or timer input	
P3.5	J10	Digital I/O or timer input	
P3.6	J9	Digital I/O or timer input	
P5.7	J8	Analog input or I/O	
P5.6	J7	Analog input or I/O	
P5.4	J6	Analog input or I/O	
P5.3	J5	Analog input or I/O	
AVDD	J3	A/D converter analog reference	

DESIGNING A THREE PHASE AC INVERTER CONTROL & INTERFACING BOARD...

8 TYPICAL APPLICATION: AC MOTOR DRIVE

The typical application for this Control Board is AC motor control. Figure 1 shows a power environment that fits this Control Board and runs an AC motor up to 600W from a 230Vac mains. The power range can be extended to 1kW by doubling the bulk capacitor and adapting the heatsink.

An example implementation is shown in Figure 2.

The Control Board is mounted on the Power Board next to the power switches.

Figure 1. AC Motor Drive Schematic

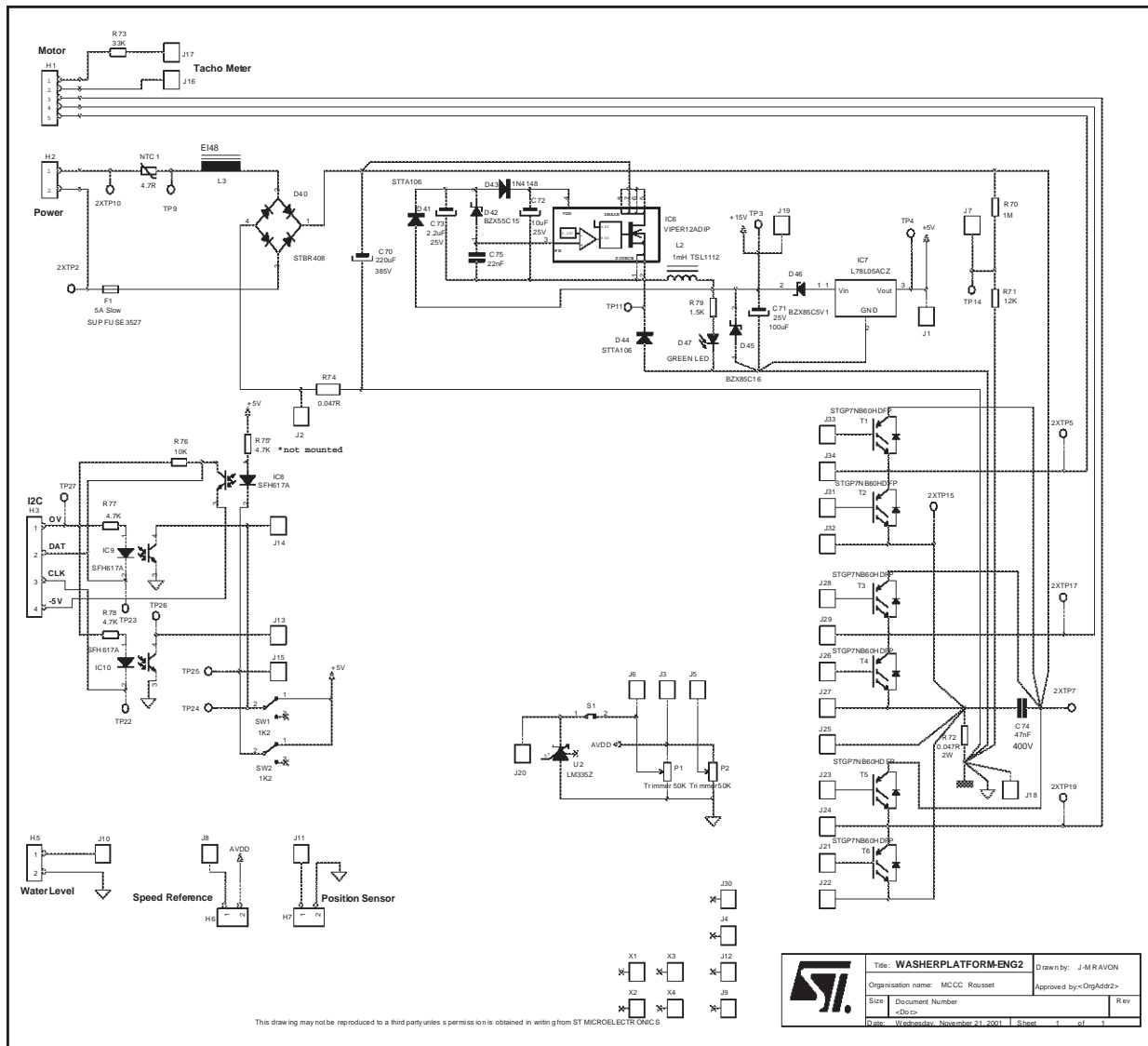

DESIGNING A THREE PHASE AC INVERTER CONTROL & INTERFACING BOARD...

Figure 2. Power Board Layout (ORCAD files available)

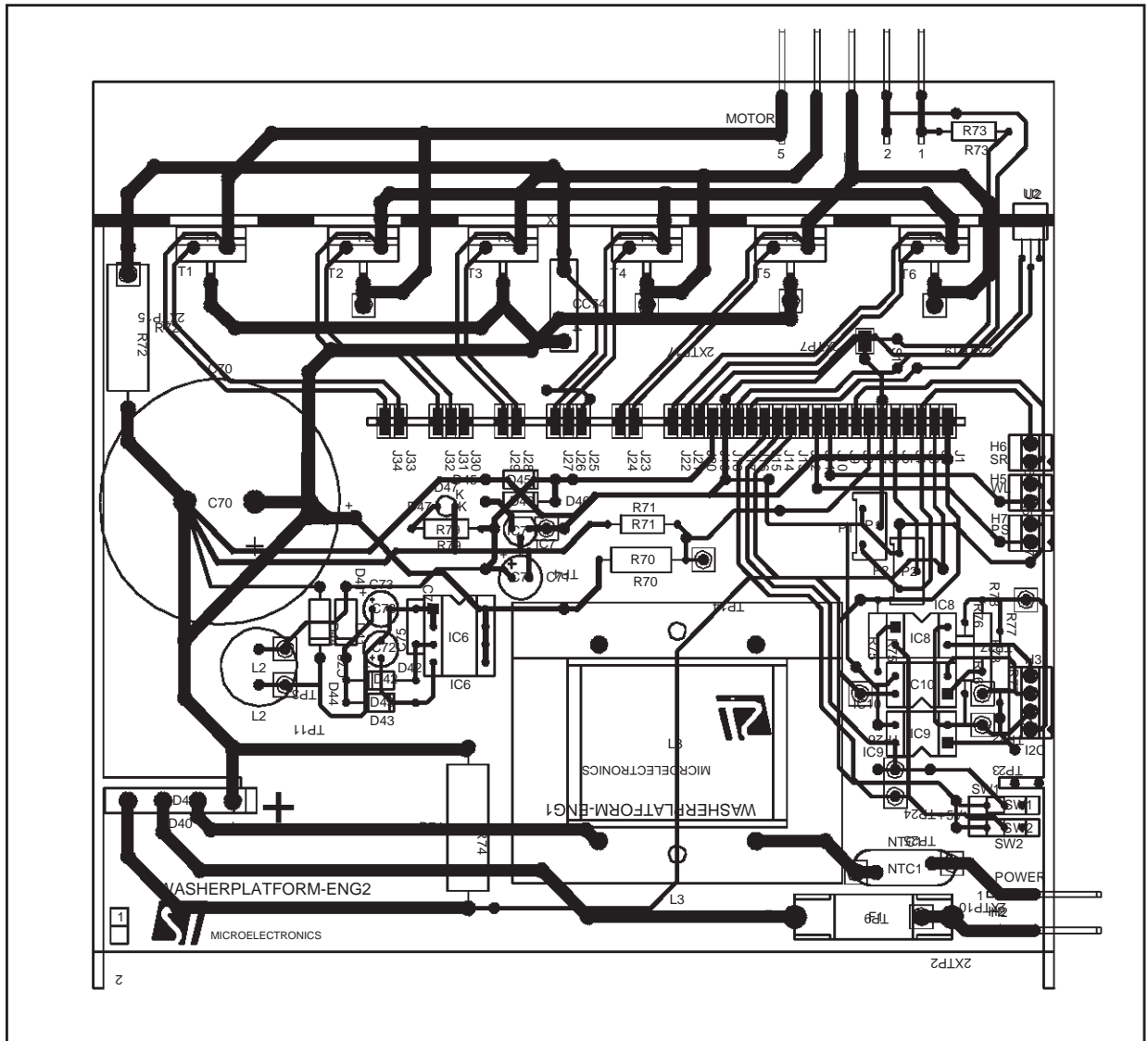

9 SYSTEM VIEWS

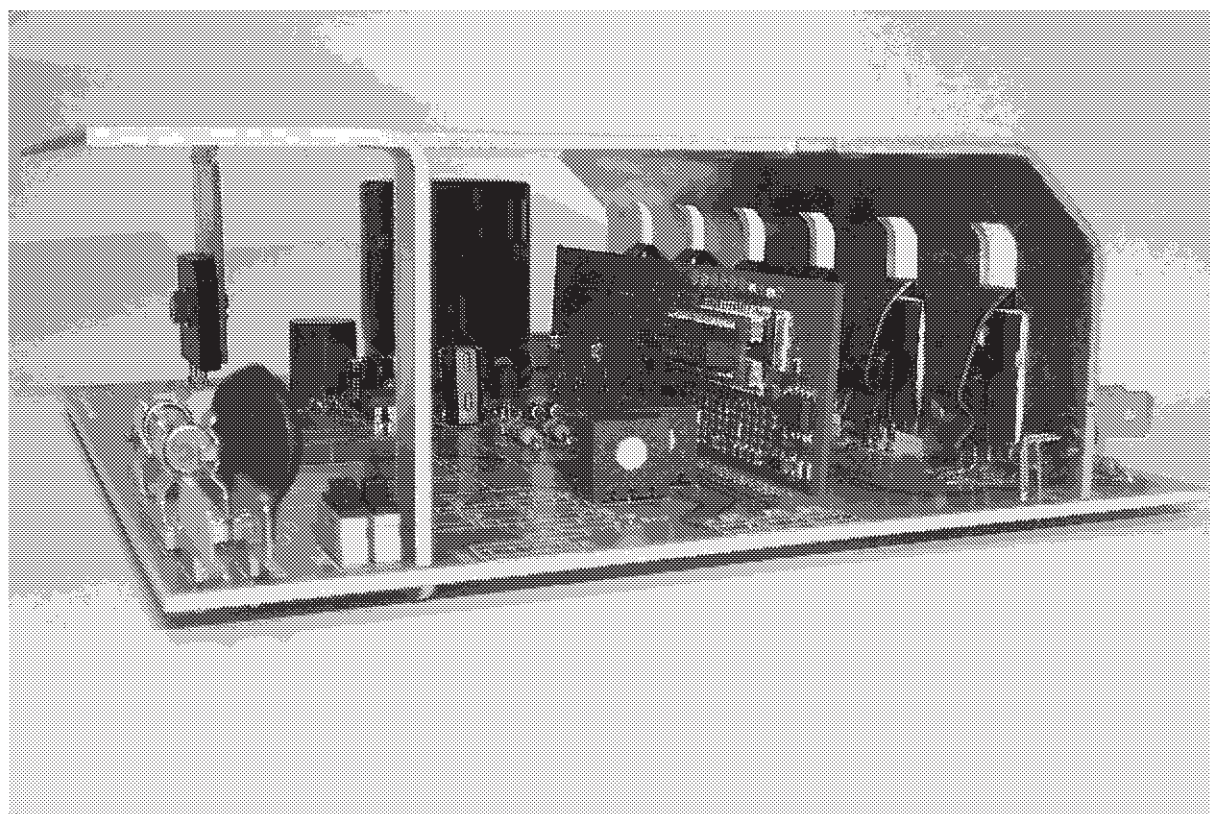
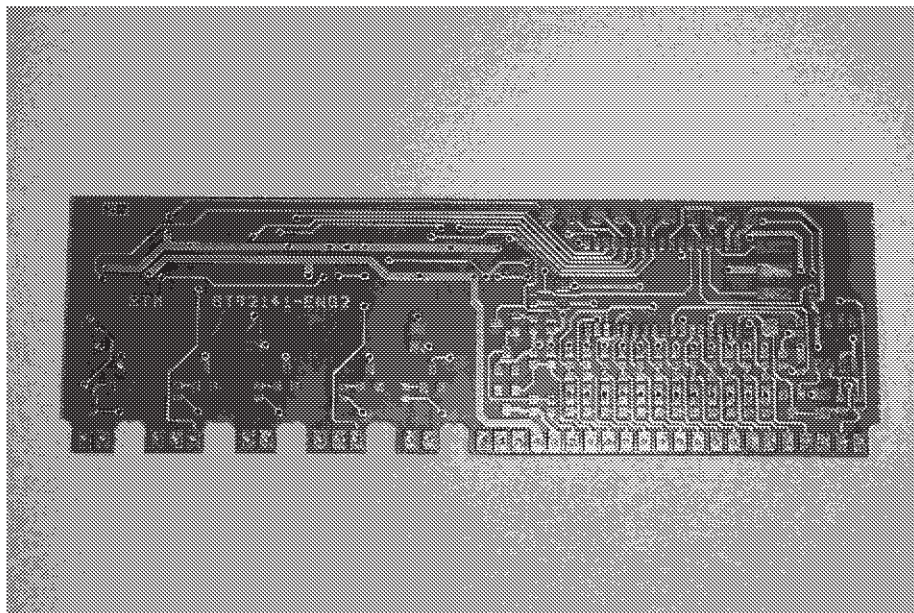

10 WASHER MOTOR DRIVE DEMONSTRATION SOFTWARE

A large number of generic macros are available to allow you to build software for your specific application (refer to AN1084, AN1277 and AN1367). To show how quickly it can be implemented, a washer motor drive demonstration program is presented in this application note. This software allows you to evaluate the performance of the ST92141 based Control Board coupled to six STGP7NB60HDFP IGBTs and controlling a 3-phase induction motor in a washing machine application. For the hardware description, refer to the schematics shown previously.

This demonstration software has been developed with ST92141 Software Library release 2.1. The application is made up of the following five modules, in addition to the Software Library modules:

- User
- Supervision
- Watchdog
- EFT (timer)
- Unbalancement

Disclaimer:

THE PRESENT SOFTWARE, WHICH IS FOR GUIDANCE ONLY, AIMS AT PROVIDING CUSTOMERS WITH INFORMATION REGARDING THEIR PRODUCTS IN ORDER FOR THEM TO SAVE TIME. AS A RESULT, STMICROELECTRONICS SHALL NOT BE HELD LIABLE FOR ANY DIRECT, INDIRECT OR CONSEQUENTIAL DAMAGES WITH RESPECT TO ANY CLAIMS ARISING FROM THE CONTENT OF SUCH SOFTWARE AND/OR THE USE MADE BY CUSTOMERS OF THE INFORMATION CONTAINED HEREIN IN CONNECTION WITH THEIR PRODUCTS.

10.1 ST92141 SOFTWARE LIBRARY

This library provides ready-to-use functions to run a standard three-phase AC motor. It is fully documented in application notes AN1084, AN1277 and AN1367.

The motor parameters (max. voltage, optimum slip, number of poles, tachometer characteristics...) can be set easily to fit the motor characteristics. The default parameters correspond to the AHV SELNI motor.

10.2 ST92141 DEVELOPMENT TOOLS

ST9+ V6 Software Toolchain.

See <http://www.st.com>, Microcontroller section.

10.3 HOW TO RUN THE SOFTWARE

The SW1 and SW2 switches allow the 3 following modes to be selected:

- Wash mode 1
- Wash mode 2
- Spinning mode

(see schematics for pin-out)

10.3.1 Wash mode 1

Rotor speed is 90Hz (WASH SPEED constant in USERParm.h)

Ton = 3sec., Toff = 12sec.

The direction is toggled after each cycle.

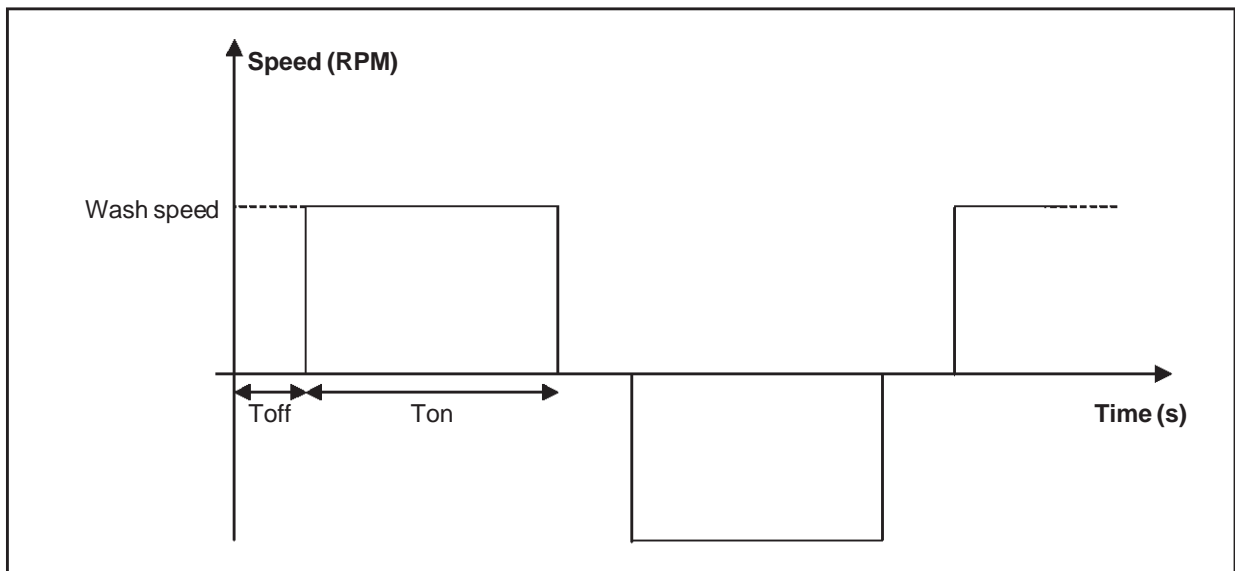

10.3.2 Wash mode 2

Rotor speed is 90Hz (WASH SPEED constant in USERParm.h).

Ton & Toff are adjusted by the RV2 & RV3 trimmers on the Power Board, 2sec. < Toff < 10sec., 5sec < Ton < 20sec. (turn clockwise to decrease time)

Two trimmers can adjust the moving and waiting periods.

The direction is toggled after each cycle.

10.3.3 Spinning mode

The spinning profile is defined in the table below (motor speeds in RPM and times in seconds):

- If the time is equal to zero, then acceleration is as fast as possible (limited by maximum allowed torque)
- If both speed and time are equal to zero, then the spinning phase ends and CPU waits for a new mode.

The default profile is the following:

Rotor target speed (RPM)	Time (s)
1000	10
1000	10
0	10
1300	5
1300	5
3000	5
10000	50
10000	30
12000	20
12000	30
16000	40
16000	60
0	0

10.4 FUNCTIONAL DESCRIPTION

10.4.1 Soft Start

This purpose of this function is to start the motor (in washing or spinning mode).

The start-up consists of fixing the stator frequency and slowly increasing the motor voltage. The slip regulation is disabled. The voltage ramp has two slopes. The first slope is steeper than the second one. When the start-up speed is reached, the slip regulation is enabled and the CPU goes into sustaining speed mode (washing) or to ramping-up.

Figure 3. Start-up

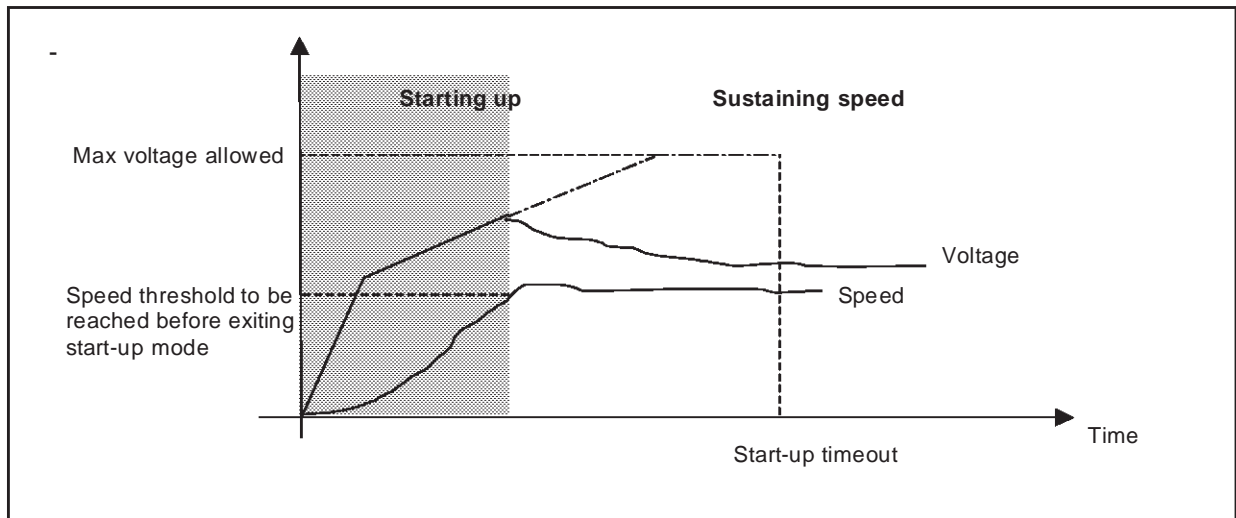

If the speed feedback is not available (for example due to a tachometer problem), a time-out stops the PWM and exits the start-up sequence.

Figure 4. Start-up timeout

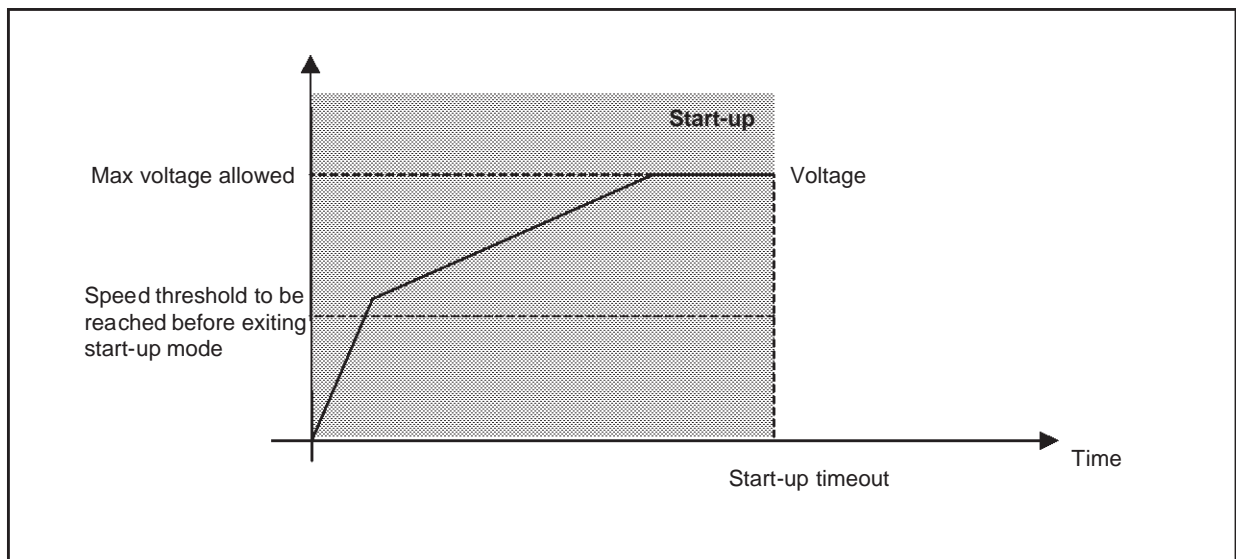

Start-up optimization during wash cycles

Figure 5. Repetitive start-up in wash cycles

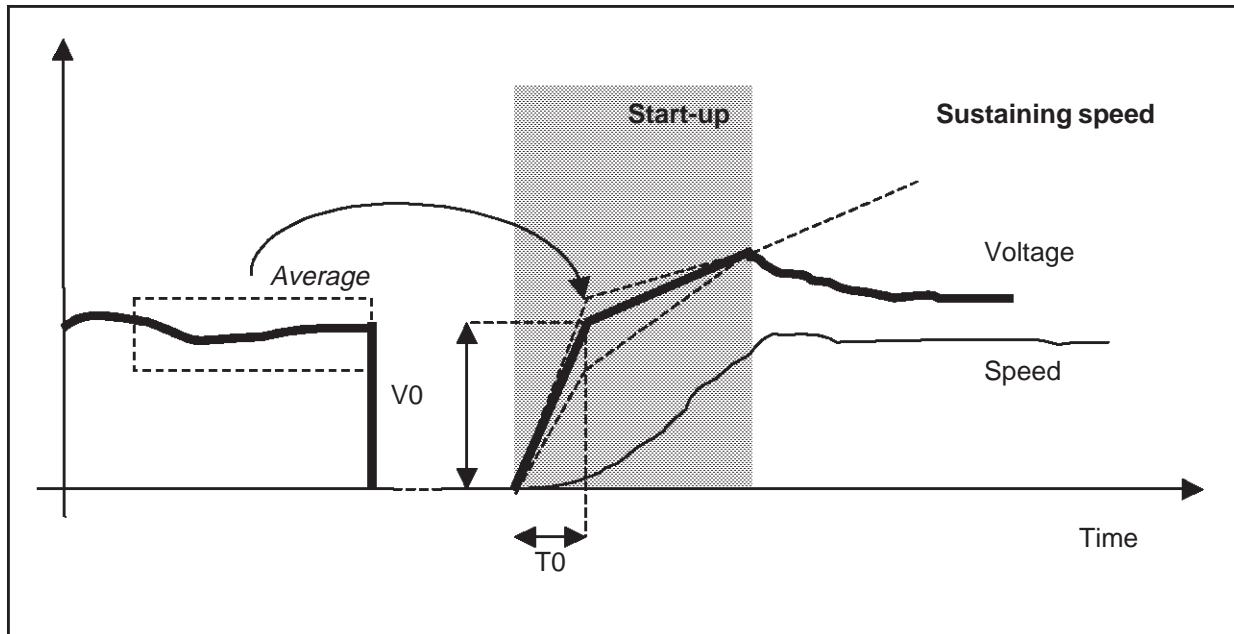

T_0 time is a constant. V_0 voltage is the average applied during the final seconds before the last stop. This adaptive start-up allows torque to be optimized depending on the load (compromise between rise time and current over-shoot). The higher the load, the higher the torque needed to start the motor.

10.4.2 Ramp-up

The ramp-up function allows the motor speed to be increased. It is defined by:

- Target speed
- Time needed to reach this target speed

The stator frequency unit is 0.1Hz and the time unit is 10ms (regulation loop time).

The difference between the target speed and the actual speed defines the number of steps (0.1Hz each).

The time to reach the target speed versus the number of steps gives the step time.

Therefore, the maximum slope is 10Hz per second.

If the motor slip exceeds its allowed limit during the acceleration, the frequency does not increment until the slip comes within this limit.

10.4.3 Sustain speed

The purpose of this function is to maintain the motor speed by regulating the optimal motor slip.

10.4.4 Decrease speed

In some cases, for example when the input power gets too high, the speed must be slowed down.

This function saves the motor voltage and disables the slip regulation and the PWM. Then the motor speed decreases naturally. When it reaches the target speed, the new stator frequency is set and the PWM outputs are enabled. Simultaneously the motor voltage is increased progressively from zero to the previously saved value. The slip regulation routine may be started as well as the sustain speed routine.

10.4.5 Motor stop

Before setting a new mode (washing, dry-spinning), the motor must be stopped to avoid energy return from motor to converter.

10.4.6 Voltage limitation

See AN1084

10.4.7 Slip regulation

See AN1084

10.4.8 Speed measurement protection / locked rotor

During the start-up routine, if the timer overflows before the motor runs, either the rotor is locked or the speed is not accessible. After several trials, the default flag may be set.

In normal operation, if the tachometer counter suddenly overflows, the PWM is immediately disabled. After checking, if problem re-occurs, the default flag may be set.

10.4.9 Unbalancement measurement

Note: This is only an unbalancement measurement. Unbalancement control has to be implemented by the washing machine manufacturer.

Unbalancement measurement is done at a fixed speed. It is based on the fact that the motor slip variation is proportional to that unbalancement. The algorithm is the following.

First the average motor voltage is computed over a three second period. Then the slip regulation is disabled and the motor voltage is set to this average value. Then during one second, the motor slip span is measured. This span is averaged with four or five values, depending on the speed. The unbalancement is proportional to the average slip span.

10.4.10 Heatsink over-temperature

A hardware protection (LM335 temperature sensor on the power board) disables the L6386 drivers and stops the motor in case of heatsink over-temperature. Therefore, the microcontroller software is interrupted by a falling-edge on the NMI interrupt pin. The PWM outputs are put in high-impedance.

In wash mode, the motor is stopped and restarts as soon as the default disappears (high level signal on the NMI pin).

In spinning mode, the motor is stopped and restarts at the beginning of the whole profile as soon as the default disappears.

The over-temperature protection level can be adjusted by the R51/R48/R80 resistant divider and the R51/C36 filter on the Control Board. The default threshold is about 100°C.

10.4.11 Thermal monitoring

The microcontroller can also read the heatsink temperature through an analog input (not implemented in this software). The designer can program, for example, the following de-rated modes if temperature exceeds 90°C:

- Ton is shorted if washing
- Spinning speed is decreased if spinning

10.4.12 DC bus voltage supervision

If the DC line voltage decreases to 200V, the microcontroller stops the PWM to slow down the bulk capacitor discharge. Therefore the auxiliary supply can operate for a significant time preventing the microcontroller from resetting. The PWM is enabled as soon as the voltage reaches 200V.

When washing, the CPU waits for the rotor stop and then restarts as soon as the default disappears (high level signal on the NMI pin).

When spinning, the CPU waits for the rotor stop and then restarts the whole profile as soon as the default disappears.

10.4.13 Input power supervision

In spinning mode, an input power limitation can be implemented, for two main reasons:

- Limit the current harmonics emitted on the mains
- Risk of heatsink over-heating

The DC bus voltage and the peak input current values are measured via analog inputs. The product of these two values gives an indication of the input power.

The default maximum power is set at about 600W (in USERParm.h). If the input power becomes higher than 600W, the speed is either decreased or limited depending on the operation (steady state or accelerating).

10.4.14 Motor over-current

A hardware protection disables the L6386 drivers and stops the motor in case of instantaneous over-current.

In this case, the microcontroller software is interrupted by a falling edge on the NMI interrupt pin. The PWM outputs are put in high-impedance.

In wash mode, the motor is stopped and restarts as soon as the default disappears (high level signal on the NMI pin).

In spinning mode, the motor is stopped and restarts at the beginning of the whole profile as soon as the default disappears.

The over-current protection threshold can be adjusted by the R26/R27 resistor divider and the R27/C17 filter on the control board. The default threshold corresponds to about 12A peak on the motor phase sinusoidal current.

10.4.15 Watchdogs (main watchdog and peripheral watchdogs)

The Watchdog peripheral resets the microcontroller if the software locks-up.

The PWM, A/D converter and EFT timer interrupts are managed by the software. These interrupts occur at regular intervals. The period of these interrupts is lower than the main loop time.

A counter is incremented each time a PWM interrupt occurs. This counter value is read in the software main loop. If it is not equal to zero, it is reset and the main loop is kept running. If the counter is zero, an infinite loop is forced and the watchdog peripheral resets the microcontroller.

Similar counters are set for the A/D converter and EFT timer.

10.5 FUNCTION LIST

USER module

USER_Mode_Init
USER_Mode_Detect
USER_Calculate_VF_Wash_1
USER_Calculate_VF_Wash_2
USER_Wash
USER_WashAverageVoltageInit
USER_WashAverageVoltageUpdate
USER_WashAverageVoltageCalculation
USER_WashSoftStartVoltageDetermination
USER_Init_Spinning_Array
USER_Calculate_VF_Spin
USER_SoftStart
USER_InitRegul
USER_SustainSpeed
USER_RampUp
USER_DecreaseSpeed

Supervision module (supervis.c)

USER_MicroCuts_Handling
USER_NMI_Init
NMI_Interrupt_Routine
USER_NMI_Handling
USER_TachoFailure_Handling
USER_MainsPower_Handling

Watchdog module

Watchdog_Init
Watchdog_Get_Counter_HB
Watchdog_Reload
USER_Reset_Watchdog_Counters
USER_Watchdog_Handling

EFT module

EFT_Init
EFT_OC1_Get_WDT_Counter
EFT_OC1_Set_WDT_Counter
EFT_OC1_Clear_WDT_Counter
USER_TimebaseInit
USER_Timebase
USER_Sec_Counter_Elapsed
USER_Sec_Counter_2_Elapsed;
USER_Sec_Counter_3_Elapsed

DESIGNING A THREE PHASE AC INVERTER CONTROL & INTERFACING BOARD...

USER_Get_Sec_Counter_Value
USER_Get_Sec_Counter_2_Value
USER_Load_Sec_Counter
USER_Load_Sec_Counter_2
USER_Load_Sec_Counter_3
USER_Read_Interface
EFT_Interrupt_Routine

Unbalancement module (unbal.c)

USER_Unbal
USER_UnbalRegul
USER_UnbalAverageVoltageCalculation
USER_UnbalStopRegul
USER_UnbalSlipMeasurement
USER_GetUnbal

DESIGNING A THREE PHASE AC INVERTER CONTROL & INTERFACING BOARD...

“THE PRESENT NOTE WHICH IS FOR GUIDANCE ONLY AIMS AT PROVIDING CUSTOMERS WITH INFORMATION REGARDING THEIR PRODUCTS IN ORDER FOR THEM TO SAVE TIME. AS A RESULT, STMICROELECTRONICS SHALL NOT BE HELD LIABLE FOR ANY DIRECT, INDIRECT OR CONSEQUENTIAL DAMAGES WITH RESPECT TO ANY CLAIMS ARISING FROM THE CONTENT OF SUCH A NOTE AND/OR THE USE MADE BY CUSTOMERS OF THE INFORMATION CONTAINED HEREIN IN CONNECTION WITH THEIR PRODUCTS.”

Information furnished is believed to be accurate and reliable. However, STMicroelectronics assumes no responsibility for the consequences of use of such information nor for any infringement of patents or other rights of third parties which may result from its use. No license is granted by implication or otherwise under any patent or patent rights of STMicroelectronics. Specifications mentioned in this publication are subject to change without notice. This publication supersedes and replaces all information previously supplied. STMicroelectronics products are not authorized for use as critical components in life support devices or systems without the express written approval of STMicroelectronics.

The ST logo is a registered trademark of STMicroelectronics

©2002 STMicroelectronics - All Rights Reserved.

Purchase of I²C Components by STMicroelectronics conveys a license under the Philips I²C Patent. Rights to use these components in an I²C system is granted provided that the system conforms to the I²C Standard Specification as defined by Philips.

STMicroelectronics Group of Companies

Australia - Brazil - Canada - China - Finland - France - Germany - Hong Kong - India - Israel - Italy - Japan
Malaysia - Malta - Morocco - Singapore - Spain - Sweden - Switzerland - United Kingdom - U.S.A.

<http://www.st.com>



LittleDiode supplies new, hard to find or obsolete electronic components and semiconductors all over the world.

With over two million different components listed you are sure to find the part you need.

Feel free to visit us today at our online store:

LittleDiode.com

Looking forward to providing you with the best possible service.