

## Audio Xcellence: XDCP Signal Integrity Report (Audio Characterization Report)

### Introduction

Most audio equipment testing is done on a stimulus-response basis. A signal of known characteristics is fed to the input of the Device Under Test (DUT) and the output of the DUT is measured. The performance of the DUT is determined by degradation of the output signal from the known input signal. Often, sets of measurements are made as the stimulus is swept or stepped across the audio frequency spectrum or across an amplitude range, and the desired performance information is determined by the relationship between the corresponding set of output measurements.

The most common stimulus for audio testing is a sine wave. The sine wave is unique since it is the only signal to have all its energy concentrated at a single point in the frequency spectrum, referred to as the fundamental frequency. It is therefore relatively simple to analyze test results from single sine wave testing. Multiple sine waves (usually two) are used for intermodulation distortion testing, and large numbers of multiple sine waves are used for some new testing techniques. White noise,

pink noise, square waves, and impulses may also be used as stimulus for certain types of audio testing. It is also possible to make certain measurements using program material such as music or voice as stimulus.

All three of the Xicor DCP's used in this noise report were subjected to the testing criteria outlined in the above two paragraphs.

### Table of Contents

Signal to Noise Ratio	2
Total Harmonic Distortion- THD+N, & Dual Tone Tests	6
Frequency Response	12
Mutli-Channel Crosstalk & Level Matching	14
Measurement Results Summary	17
Additional Test Results	18
Appendix	21

### Test Setup Using the Audio Precision System 2

Figure 1. Audio Measurement Test Setup

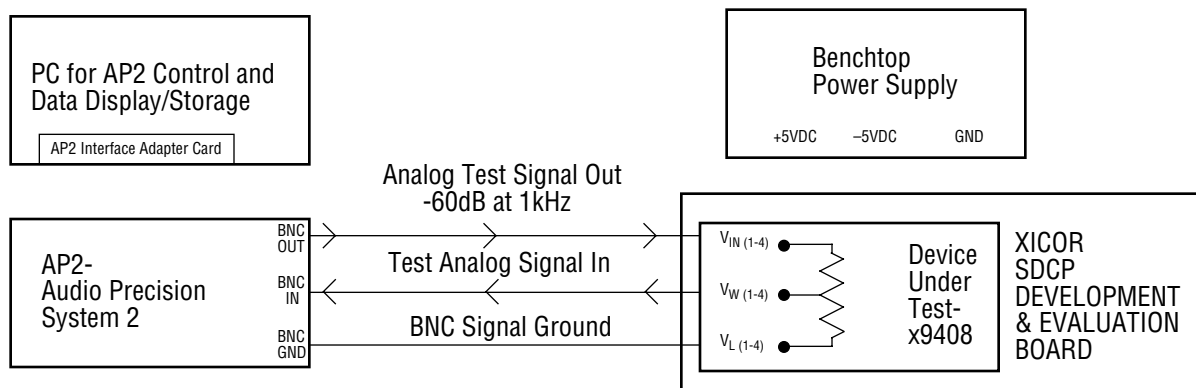



# Application Note

## Signal to Noise Ratio (SNR)

Signal to Noise Ratio (SNR) is the ratio of the normal operating level of the device compared with the device's noise floor. SNR can be thought of as the effective dynamic signal range of most types of analog audio devices.

The Signal to Noise Ratios (SNR) of the X9408/X9241/X9C102 parts are all exceptional. All three parts exceeded 119 dB SNR in the audio frequency spectrum (20Hz to 20 kHz). (See graphs for all three parts and all measurements at the end of this document). The higher the SNR values the quieter the system will be, consequently, low-level detail will become audible. Dropping the noise floor by 10 dB on the low end has the same effect as if the level control were turned up by the same amount. The SNR plots are found on the following graphs.

Applications for these parts include filters, analog signal processing, linear level control, and in any application where audio frequency analog signals are present and signal integrity and low noise is important.

SNR is determined by injecting a 0 dB, 1 KHz sine wave (generated by the AP2\*) into the input of the Device Under Test (DUT). The signal is processed by the DUT and it's output signal is then fed back into the analyzer section of the AP2. The AP2 is then adjusted to set up a 0 dB reference for this signal. The output of the AP2 is enabled again but this time the 1 KHz sine wave is removed. The output of the DUT is analyzed by the AP2 again and the ratio between this baseline noise level with no input signal and the original 0 dB level set in the first measurement is the SNR.

\*AP2-Audio Precision System 2

### A 1 KHz Sine wave at -60 dB Signal plotted from 20 Hz to 20 kHz

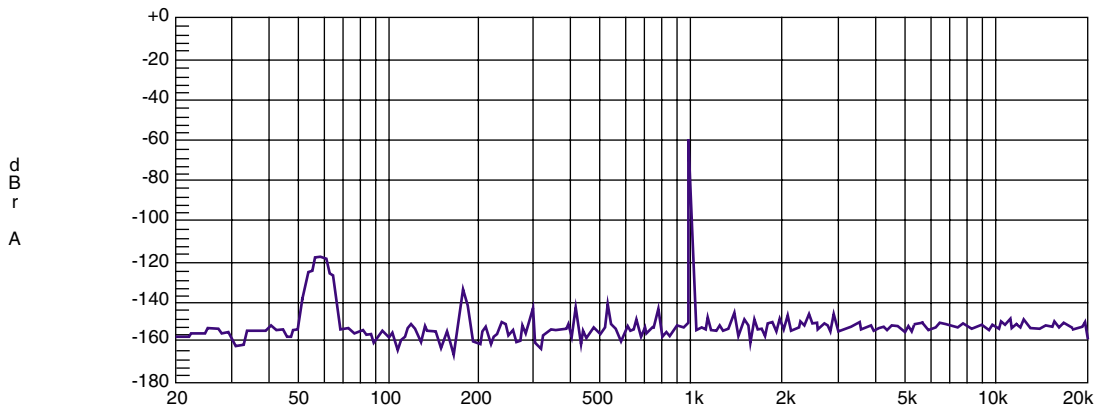

Color	Line Style	Thick	Data	Axis
Blue	Solid	1	Fft. Ch. 1 Ampl	Left

SNR Reads 116 dB on the AP2 Meter  
 XDCP9408 set at step 63 on chan 1  
 Global Specialties power supply #1310



# Application Note

## Audio Precision XICOR X9408 SNR CHAN 0

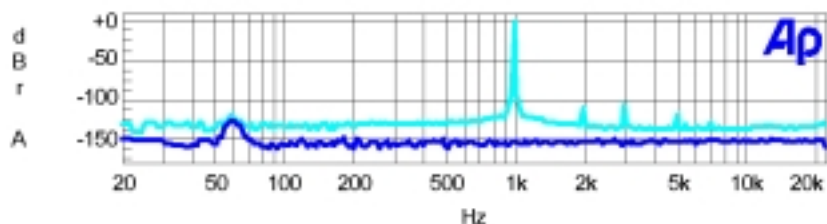

Color	Line Style	Thick	Data	Axis
Cyan	Solid	3	Fft.Ch.1 Ampl	Left
Blue	Solid	3	Fft.Ch.1 Ampl	Left

X9408w(10K ohms) SNR=120dB on Chan 0  
 1kHz@0dB Set Ref (from 1.4vp@0dB)  
 Step 63(Full On)

## Audio Precision XICOR X9241 SNR CHANNEL 0

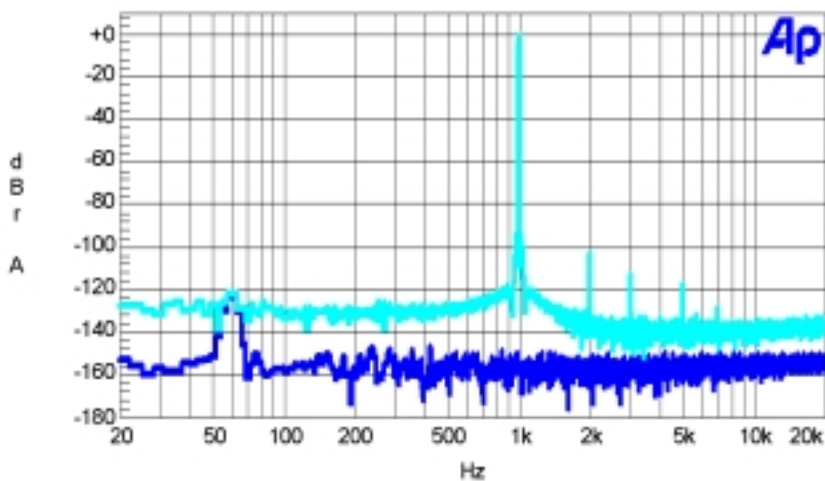

Color	Line Style	Thick	Data	Axis
Blue	Solid	3	Fft.Ch.1 Ampl	Left
Cyan	Solid	3	Fft.Ch.1 Ampl	Left

X9241y(2k ohms) SNR=119 dB on Chan 0  
 1kHz@0dB Set Ref (from 1.4vp@0dB)  
 Step 63(Full On)  
 MBPWR



# Application Note

## Audio Precision XICOR X9C102 SNR

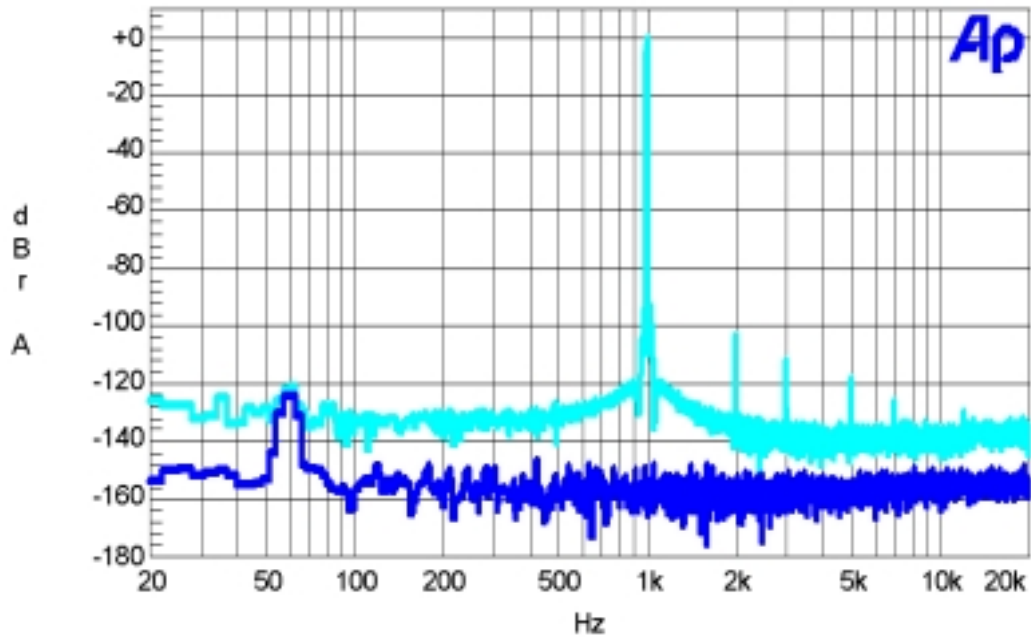

Color	Line Style	Thick	Data	Axis
Cyan	Solid	3	Fft.Ch.1 Ampl	Left
Blue	Solid	3	Fft.Ch.1 Ampl	Left

X9C102(1K ohms) SNR= 119dB  
1kHz@0dB Set Ref (from 1.4vp@0dB)  
Step 99(Full On)  
MBPWR



# Application Note

---

## **Total Harmonic Distortion- THD+N, & Dual Tone Tests**

The THD+N (Total Harmonic Distortion + Noise) level for all three parts is below -100dB which is exceptional for this class of parts. (See graphs for all three parts and all measurements at the end of this document). The dual tone type of tests are less common than the THD+N tests but are valuable in revealing problems with intermodulation distortion. In the parts that were measured with two lone tests at various frequencies generated no harmonics greater than -105dB.

In particular these two specifications define a parts audio frequency performance quality and assure a circuit designer that all three will work well as analog signal attenuators without adding extra harmonics. The results of these tests clearly show that all three of the Xicor parts exhibit excellent low level harmonic tendencies.

Applications for these parts include filters, analog signal processing, linear level control, and in any application where audio frequency analog signals are present and need to be easily controlled and where signal integrity is important.

### **Total Harmonic Distortion + Noise (THD+N):**

Measured by attenuating the fundamental signal (1 KHz @ 0 dB) with a narrow-band notch filter, then measuring the remaining signals which consist of harmonics of various orders, wide-band noise, and possibly interfering signals. THD causes audio signals to become smeared and less clear/focused. It can also raise baseline noise levels which masks out low level audio information. Creating extra signals and adding them back into the final output is always a BAD Thing.

**Two Tone Harmonic Test:** Where two 0 dB signals at two different frequencies are fed into the DUT and the output is then measured by the AP2 across the entire audio frequency range (from 20 Hz to 20 kHz). Any harmonics (extra signals at even or odd multiples of the original two signals and multiples of their differences as well) created from the injection of these two signals into the DUT are displayed on a log frequency vs. amplitude graph. This test is useful in revealing any higher audio frequency anomalies which can be created by bad layout, non-linear responses, stray capacitance, and other circuit abnormalities. The audibility of this type of distortion is another form of THD. Plots of THD+N are found on this and the following 3 pages.

# Application Note

Audio Precision XICOR X9408 THD+N CHAN 0

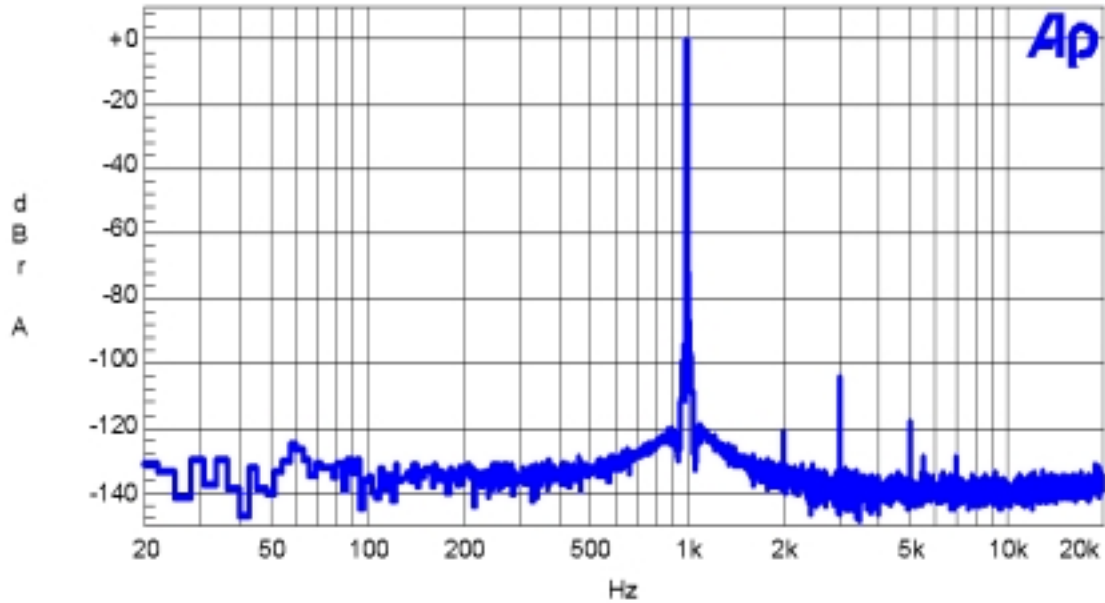

Color	Line Style	Thick	Data	Axis
Blue	Solid	3	Fft.Ch.1 Ampl	Left

  

<p>X9408w(10K ohms) CHAN 0          THD+N = 106dB          1kHz@ 1.4vp-0dB          Step 63(last step) - AP2 Z @ 100K          MBPWR</p>
--



# Application Note

## Audio Precision XICOR X9241 THD+N CHAN 0

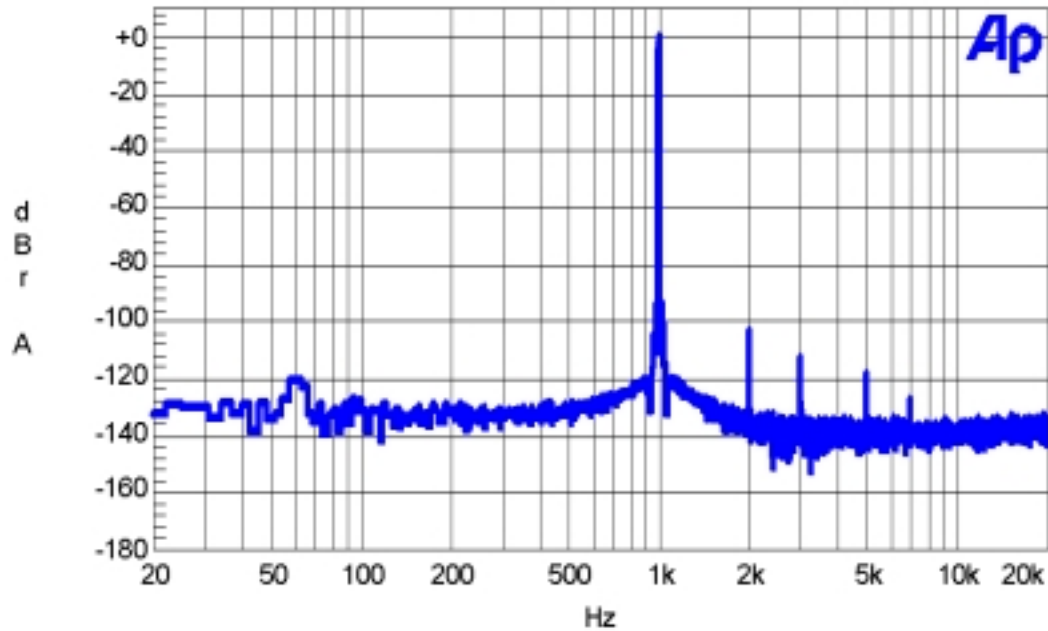

Color	Line Style	Thick	Data	Axis
Blue	Solid	3	Fft.Ch.1 Ampl	Len

X9241y(2K ohms) THD+N @ 1kHz @ 0dB=101dB  
Channel 0 Set @ Step 63  
AP2 100k Input Z, 5000 pts.  
MBPWR



# Application Note

## Audio Precision XICOR X9C102 THD+N

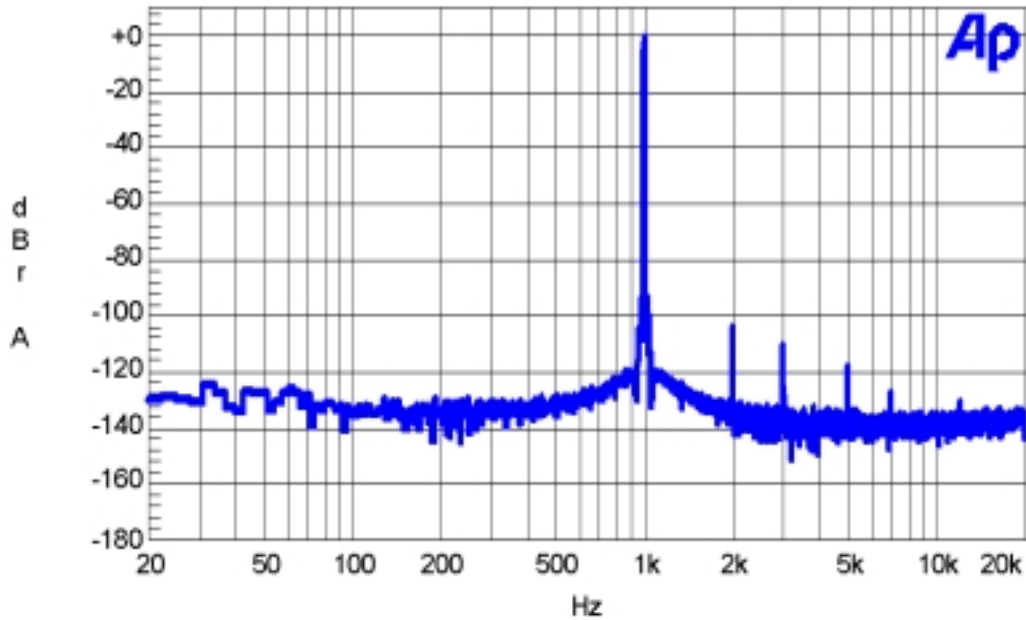

Color	Line Style	Thick	Data	Axis
Blue	Solid	3	Fft.Ch.1 Ampl	Left

X9C102(1K ohms) THD+N = -102dB  
1kHz@0dB (from 1.4vp@0dB)  
Step 99  
MBPwr



# Application Note

## Audio Precision XICOR X9408 DUAL TONE IMD TEST 18-19kHz CHAN 0

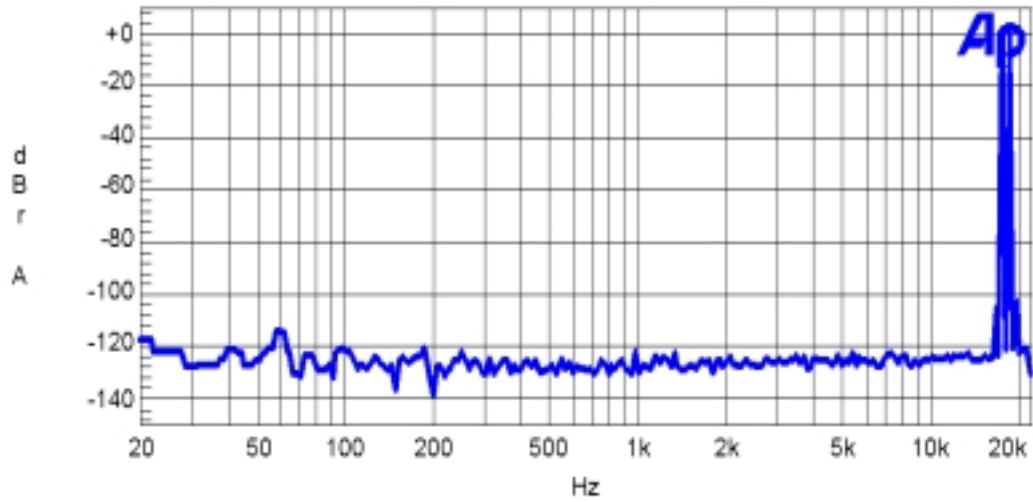

Color	Line Style	Thick	Data	Axis
Blue	Solid	3	Fft.Ch.1 Ampl	Left

X9408w(10K ohms) DUAL TONE TEST  
CHAN 0  
18.19kHz@0dB (from 1.4vp@0dB)  
AP2 Input Z = 100k ohms  
Step 63



# Application Note

## Audio Precision XICOR X9241 DUAL TONE IMD TEST CHAN 0

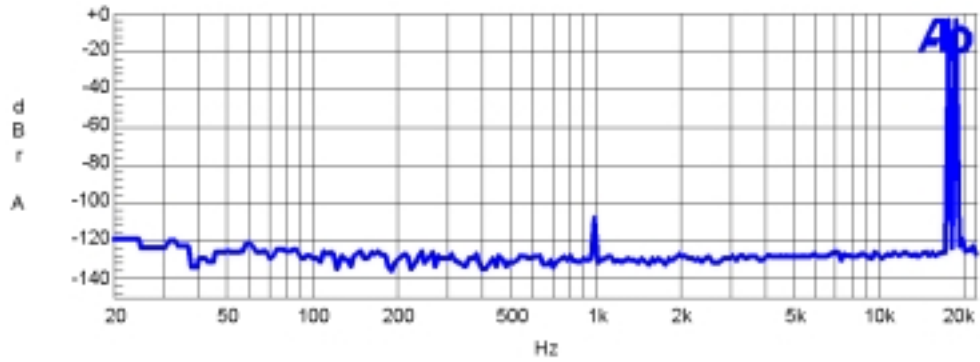

Color	Line Style	Thick	Data	Axis
Blue	Solid	3	Fit.Ch.1 Ampl	Left
Blue	Solid	3	Fit.Ch.1 Ampl	Left

X9241x(2K ohms) Two Tone Test  
18\_19kHz @ 0dB  
channel 0, Step 63  
MBPvR



# Application Note

## Audio Precision XICOR X9C102 DUAL TONE IMD TEST

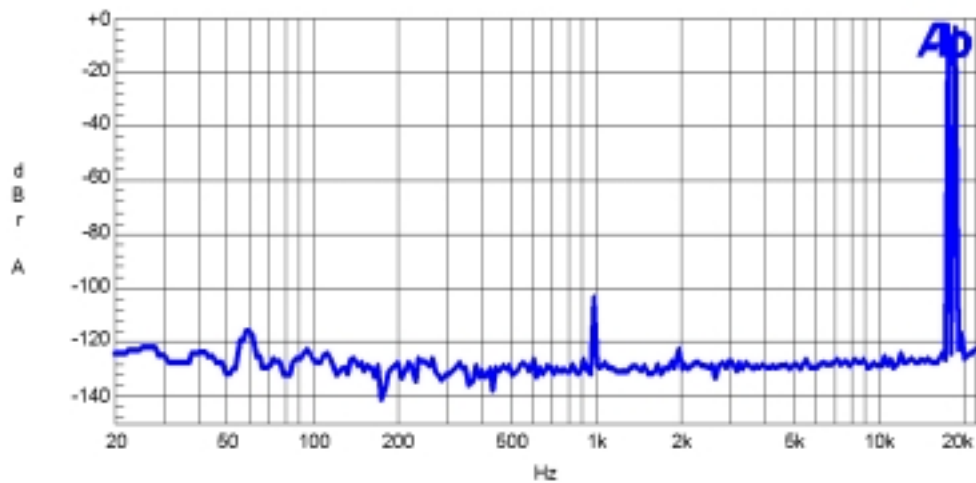

Color	Line Style	Thick	Data	Axis
Blue	Solid	3	Fft.Ch.1 Ampl	Left
Blue	Solid	3	Fft.Ch.1 Ampl	Left

>9C102(1K ohms) Two Tone Test 18.19kHz @ 0dB Step 99 MBPWR
---



# Application Note

---

## **FREQUENCY RESPONSE**

The upper frequency response limit of an analog system is usually determined by the point at which the input signal is reduced by the DUT (the circuit or part being tested) on its output by a factor of  $-3$  dB. This standard of  $-3$  dB down corresponds to  $1/2$  power or  $.707$  times the voltage of the input signal. All the Xicor parts tested (using the Audio Precision System 2) were flat to 200 kHz, which is the upper measurement frequency limit of the AP2 (10 times the bandwidth of a standard 20 kHz audio signal). The AP2 plots of the frequency response, of the three parts being tested, are found in the following 2 pages.

These three parts therefore have no frequency based limitations in the audio frequency range which make them suitable for any application that requires signal level attenuation such as low frequency square wave generators, data loggers, vibration analyzers, noise cancellation equipment, environmental controls, etc.



# Application Note

## Audio Precision XICOR X9408 CHAN 0 Frequency Response

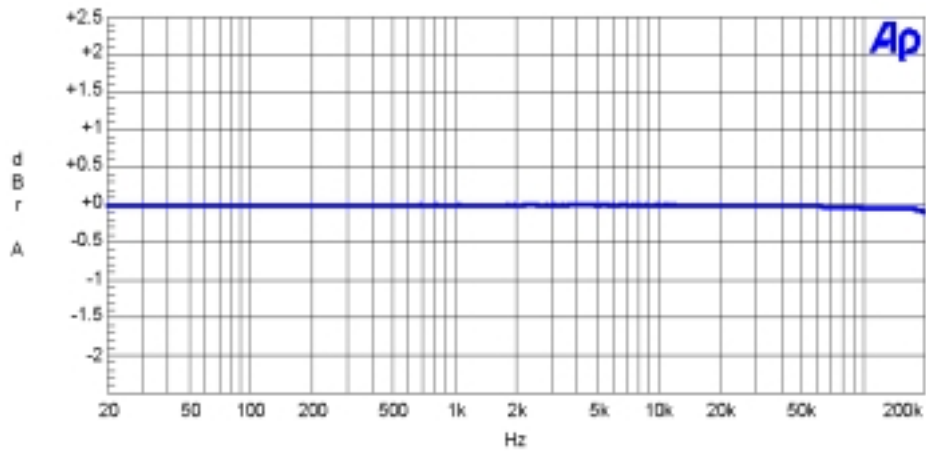

Color	Line Style	Thick	Data	Axis
Blue	Solid	3	Anlr.Level A	Left

X9408W(10K ohm) Frequency Response  
1.4vp 20Hz to 200 kHz on chan 0  
AP2 Input Z = 100k ohms  
MBPWR

## Audio Precision XICOR X9241 CHAN 0 Frequency Response

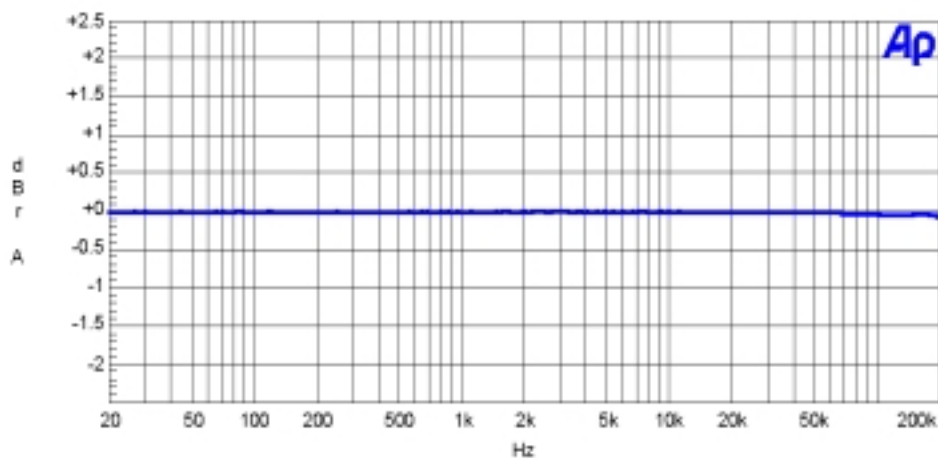

Color	Line Style	Thick	Data	Axis
Blue	Solid	3	Anlr.Level A	Left

X241y(2K ohms) Frequency Response  
1.4vp 20Hz to 200 kHz on chan 0  
AP2 Input Z = 100k ohms  
MBPWR



# Application Note

## Audio Precision XICOR X9C102 FREQUENCY RESPONSE

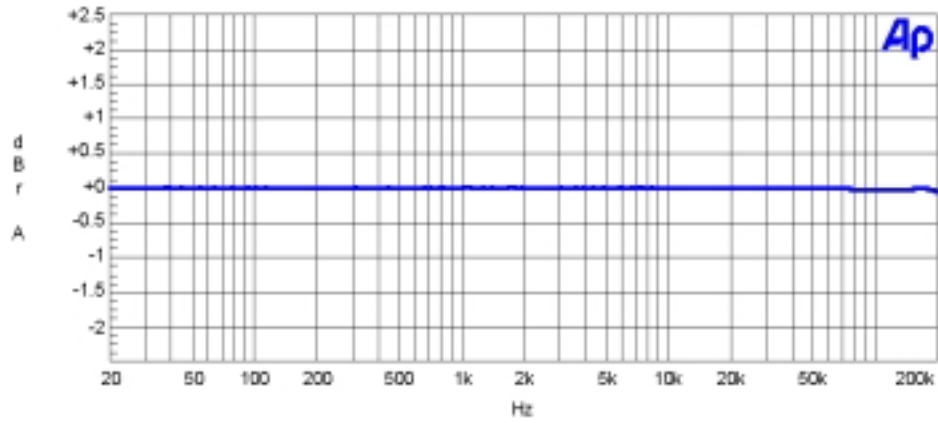

Color	Line Style	Thick	Data	Axis
Blue	Solid	3	Anlr.Level A	Left

X9C102(1K ohms) FREQUENCY RESPONSE  
0 dB - 1.4VP 20Hz TO 200kHz  
STEP 99  
MBPWR



# Application Note

## Multi-Channel Crosstalk & Level Matching

On multi-channel parts like the X9241 and X9408 any interaction between channels where the signal on one channel leaks into the other is undesirable and referred to as crosstalk. To measure crosstalk a 0 dB 1 kHz signal is inserted into one channel and the other adjacent channel/channels are left floating with no signal present. The floating channels are then measured for any signal content that leaked over from the channel being driven with a signal. The level of the signals measured on the floating channels referenced to the 0 dB, 1 kHz signal channel is the "Separation" specification number expressed in negative dB. The more negative the number the better the circuit.

Both of the Xicor parts tested measured very well for crosstalk. The crosstalk numbers expressed in negative dB were over minus -116 dB on channels that were at opposite ends of the chip and over -85 dB on directly adjacent channels. In audio applications any noise or separation number over -120dB is considered excellent.

Every 6 dB equals 1 bit in the digital representation of an analog audio signal so a number of -120dB corresponds to a 20 bit resolution which is present limit of high-end audio signals.

Where as a high negative number for crosstalk is a very good thing the opposite is true for level matching between channels on multi-channel parts. In this test the same test signal is fed into all the channels of the OUT at the same time. Then each of the individual channel output signals are measured to insure the output signal level of all of the channels match to within a certain dB level (usually 0.5 to .05 dB in consumer audio equipment). Both of the multi-channel Xicor parts (X9408 & X9241) were exceptional for this measurement.

The X9408 measured slightly better than the X9241 but the difference was so small as to be rendered meaningless. The X9408 worst case channel match between two of the four channels was .09dB and for the X9241 it was .1 dB. Most of the channels actually matched within .01 dB!

Audio Precision XICOR X9408 Separation Test Chan 0 to 2

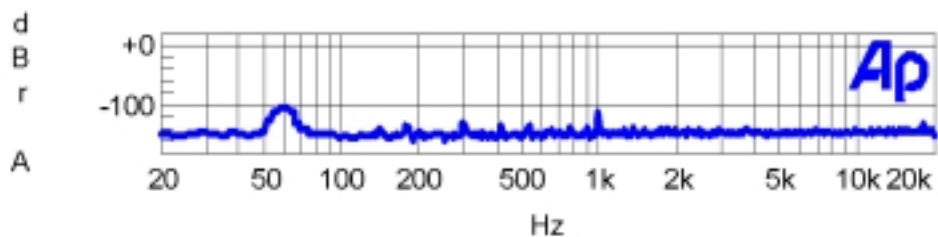

Color	Line Style	Thick	Data	Axis
Blue	Solid	3	Fit.Ch.1 Ampl	Left

X9408w(10K ohms) Chan 0 to 2 SEP = -110dB  
 1kHz @ 0dB on 1st chan measuring wiper of 2sd channel. RL g  
 MBPWR



# Application Note

## Audio Precision XICOR X9241 CROSSTALK CHAN 0 TO 2

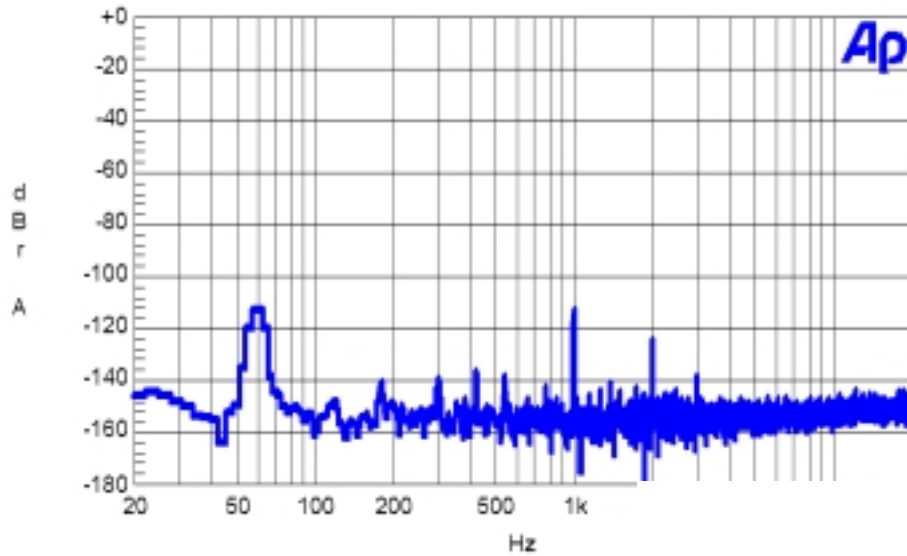

Color	Line Style	Thick	Data	Axis
Blue	Solid	3	Fit.Ch.1 Ampl	Left

X9241y(2k ohms) Chan 0 to 2 SEP = -112dB  
1kHz @ 0dB on 1st chan measuring wiper of 2nd channel  
RL grounded on all Channels.  
AP2@100k\_MBPWR



# Application Note

---

## Measurement Results Summary

### X9408

- |  |                       |
|--|-----------------------|
| 1. Signal to Noise Ratio (SNR):                        | -120dB (AP2 Calc.)    |
| 2. Total Harmonic Distortion + Noise (THD+N):          | -106dB (AP2 Calc.)    |
| 3. Frequency Response 20 Hz to 20 kHz:                 | +1- .05dB             |
| 4. Two Tone Harmonic Test (18 + 19 kHz):               | -122/-119 dB at 1 kHz |
| 5. Listen for Zipper noise (Must be below audibility): | PASSED                |
| 6. Channel Separation Range:                           | -110/-85 dB           |

### X9241

- |  |                      |
|--|----------------------|
| 1. Signal to Noise Ratio (SNR):                        | -119dB (AP2 Calc.)   |
| 2. Total Harmonic Distortion + Noise (THD+N):          | -102dB (AP2 Calc.)   |
| 3. Frequency Response 20 Hz to 20 kHz:                 | +1- .05dB            |
| 4. Two Tone Harmonic Test (18 + 19 kHz):               | -108/-99 dB at 1 kHz |
| 5. Listen for Zipper noise (Must be below audibility): | PASSED               |
| 6. Channel Separation:                                 | -116/-106dB          |

### X9C102

- |  |                    |
|--|--------------------|
| 1. Signal to Noise Ratio (SNR):                        | -119dB (AP2 Calc.) |
| 2. Total Harmonic Distortion + Noise (THD+N):          | -103dB (AP2 Calc.) |
| 3. Frequency Response 20 H~ to 20 kHz:                 | +1- .05dB          |
| 4. Two Tone harmonic Test (18 + 19 kHz):               | -103 dB at 1 kHz   |
| 5. Listen for Zipper noise (Must be below audibility): | PASSED             |



# Application Note

---

## X9408w Test Results & Observations

The X9408 was the best Xicor part when evaluated for Frequency Response, Noise (SNR and THD+N) and Channel Separation. Below are comments on each of the measurements taken and the effect of each on the audio performance of the part. It should be noted that none of these measurements were weighted.

### Frequency Response

The X9408 exhibited excellent frequency response all the way to the limit of the AP2, 200kHz. The response to 20kHz (the normal audio frequency measurement range limit) is outstanding,  $\pm .005$  dB. Ten times bandwidth to -3dB is a good rule of thumb when designing high quality audio circuits and the X9408 exceeded that requirement being only  $\pm .05$  dB down at 200 kHz!

### THD+N

The THD+N for the four channels on the X9408 with a 1 kHz 0 dB reference signal was between 106 and 107dB for all four channels! As you look at the X9408w graph on page 3, notice that there is only one harmonic at 3 kHz above -120dB. This level of performance makes this part suitable for all types of consumer audio applications.

### SNR

The SNR on the four channels of the X9408 ranged from 118dB to 120dB. In the SNR graphs it can be seen that the dominant noise in the test setup was at 60 Hz. If you notch out that signal then the SNR for the four channels falls below 150dB! In either case this spec is more than sufficient for any consumer audio application including high end equipment that uses up to 20 bits of resolution.

### Two Tone Test

Two 0 dB signals at different frequencies are fed into the DUT and the output is measured by the AP2 from 20 Hz to 20 kHz. Any harmonics created from the injection of

these two signals into the DUT are displayed on a log frequency vs. amplitude graph. The graphs of the four channels show the harmonics created in this test were very low level, on the order of -110 dB!

### Crosstalk Noise (i.e. Channel Separation)

The level of channel separation on the X9408 depends on which channels are considered. Adjacent channels have less separation (worse number) than channels at opposite ends of the part. The worst measurement was between channels 2 and 3, -85dB, and the best was between channels 2 and 0, -110 dB. With proper spacing and layout -110 dB is achievable now and is acceptable for nearly all consumer audio.

### Level Switching Noise Listening Test

The X9408 was inserted as a volume control (attenuator to ground) into the signal path of a very high end preamp that directly fed a set of ultra sensitive headphones (Grado). No level switching noise was detected by the listener at all levels.

### Channel Matching

A series of measurements were made with all four channels at different steps (volume levels, see graphs). The worst case measurement at the lowest level setting of -36 dB was  $\pm .09$  dB for all four channels to each other and the other five level settings were better than .02 dB! This was better than the other multi-channel part in the test, the X9241, by a wide margin. This is also as good as any multi-channel volume control on the market today.

### Conclusions

The X9408 exhibits excellent audio frequency performance. In any application where a linear taper level control along with low noise and low harmonic distortion are required, the X9408 is a top notch performer.



# Application Note

---

## X9241 Test Results & Observations

The X9241 was the second best Xicor part when evaluated for Frequency Response, Noise (SNR and THD+N) and Channel Separation. Below are comments on each of the measurements taken and the effect of each on the audio performance of the part. It should be noted that none of these measurements were weighted.

### Frequency Response

The X9241 exhibited excellent frequency response all the way to the limit of the AP2, 200kHz. The response to 20kHz (the normal audio frequency measurement range limit) is outstanding,  $\pm .005$  dB. Ten times bandwidth to -3dB is a good rule of thumb when designing high quality audio circuits and the X9241 exceeded that requirement being only  $\pm .05$  dB down at 200 kHz!

### THD+N

The THD+N for the four channels on the X9241 with a 1 kHz 0 dB reference signal was between 101 and 102dB for all four channels! As you look at the X9241 graph on page 4, notice that there is only one harmonic at 3 kHz above -120dB. This level of performance makes this part suitable for all types of consumer audio applications.

### SNR

The SNR measured -119 dB on four channels of the X9241. In the SNR graphs it can be seen that the dominant noise in the test setup was at 60 Hz. If you notch out that signal then the SNR for the four channels falls below 150dB! In either case this spec is more than sufficient for any consumer audio application including high end equipment that uses up to 20 bits of resolution.

### Two Tone Test

Two 0 dB signals at different frequencies are fed into the DUT and the output is measured by the AP2 from 20 Hz to 20 kHz. Any harmonics created from the injection of these two signals into the DUT are displayed on a log

frequency vs. amplitude graph. The graphs of the four channels show the harmonics created in this test were very low level, on the order of -110 dB!

### Crosstalk Noise (i.e. Channel Separation)

The level of channel separation on the X9241 depends on which channels are considered. Adjacent channels have less separation (worse number) than channels at opposite ends of the part. The worst measurement was between channels 2 and 3, -106dB (-21 dB better than the X9408), and the best was between channels 2 and 0, -116 dB (-6 dB better than X9408). With proper spacing and layout -116 dB is achievable now and is acceptable for nearly all consumer audio.

### Level Switching Noise Listening Test

The X9241 was inserted as a volume control (attenuator to ground) into the signal path of a very high end preamp that directly fed a set of ultra sensitive headphones (Grado). No level switching noise was detected by the listener at all levels.

### Channel Matching

A series of measurements were made with all four channels at different steps (volume levels, see graphs). The worst case measurement was  $\pm .1$  dB for all four channels to each other and the best case was .02 dB! This is also as good as any multi-channel volume control on the market today.

### Conclusions

The X9241 exhibits excellent audio frequency performance. In any application where a linear taper level control along with low noise and low harmonic distortion are required, the X9241 is a top notch performer.



# Application Note

---

## X9C102 Test Results & Observations

The X9C102 measurements are discussed below with comments on each of the measurements taken and the effect of each on the audio performance of the part. It should be noted that none of these measurements were weighted.

### Frequency Response

The X9C102 exhibited excellent frequency response all the way to the limit of the AP2, 200kHz. The response to 20kHz (the normal audio frequency measurement range limit) is outstanding,  $\pm .005$  dB. Ten times bandwidth to -3dB is a good rule of thumb when designing high quality audio circuits and the X9C102 exceeded that requirement being only  $\pm .05$  dB down at 200 kHz!

### THD+N

The THD+N for the four channels on the X9C102 with a 1 kHz 0 dB reference signal was between 103dB. As you look at the X9C102 graph on page 5, notice that there is only one harmonic at 3 kHz above -120dB. This level of performance makes this part suitable for all types of consumer audio applications.

### SNR

The SNR measured -119 dB on the X9C102. In the SNR graphs it can be seen that the dominant noise in the test setup was at 60 Hz. If you notch out that signal then the

SNR for the four channels falls below 140dB! In either case this spec is more than sufficient for any consumer audio application including high end equipment that uses up to 20 bits of resolution.

### Two Tone Test

Two 0 dB signals at different frequencies are fed into the DUT and the output is measured by the AP2 from 20 Hz to 20 kHz. Any harmonics created from the injection of these two signals into the DUT are displayed on a log frequency vs. amplitude graph. The graphs of the four channels show the harmonics created in this test were very low level, on the order of -103 dB!

### Level Switching Noise Listening Test

The X9C102 was inserted as a volume control (attenuator to ground) into the signal path of a very high end preamp that directly fed a set of ultra sensitive headphones (Grado). No level switching noise was detected by the listener at all levels.

### Conclusions

The X9C102 exhibits excellent audio frequency performance. In any application where a linear taper level control along with low noise and low harmonic distortion are required, the X9C102 is a top notch performer.



# Application Note

## Appendix

### Audio Precision XICOR X9408 4 Channel Level Matching AT Six Different Level Settings

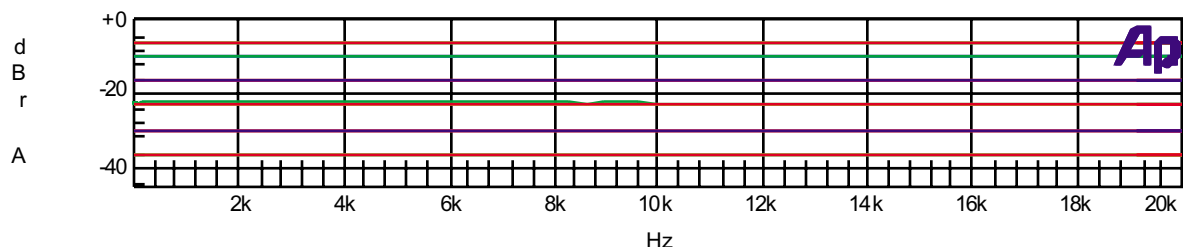

Color	Line Style	Thick	Data	Axis
Cyan	Solid	1	Anlr.LevelA	Left
Green	Solid	1	Anlr.LevelA	Left
Yellow	Solid	1	Anlr.LevelA	Left

X9408 Frequency Response ALL 4 CHANS  
 STEP 31 = -6dB, STEP20=-10dB, STEP 10=-16dB, STEP5=-22dB, STEP 2=-30dB, STEP 1=-38dB.  
 LAST STEP PURPLE =3, BLUE=2, CYAN=1, GREEN=0  
 Spread @ -6dB = ±.02dB, @ -10dB = ±.015dB, @ -16dB = ±.01dB,  
 @-22dB = ±.01dB, @-30dB = ±.012dB, @-36dB = ±.09dB,  
 1.4vp20Hz to 200kHz on chan 0  
 AP2 Input Z = 100k ohms, MB PWR

### Audio Precision XICOR X9241 ALL CHAN Frequency Response

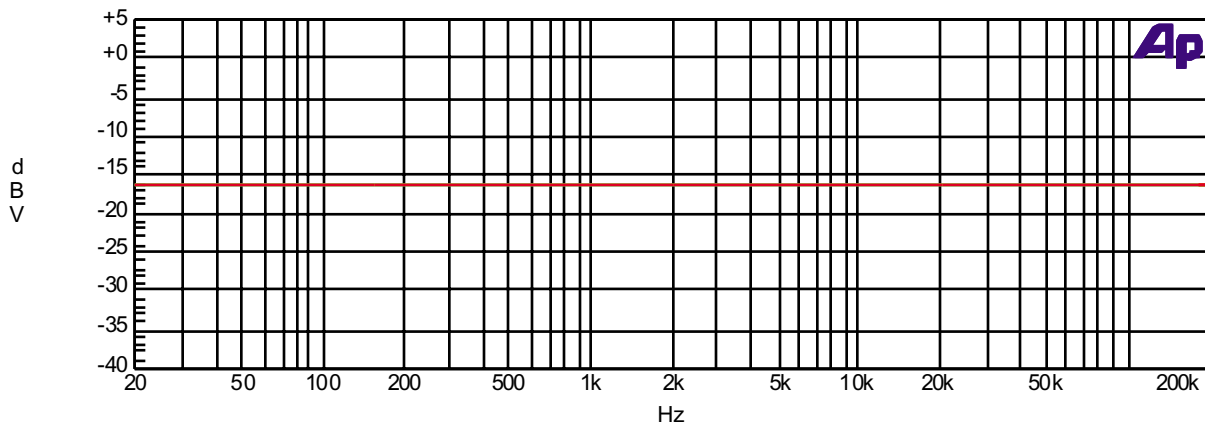

Color	Line Style	Thick	Data	Axis
Cyan	Solid	3	Anlr.LevelA	Left
Green	Solid	3	Anlr.LevelA	Left
Yellow	Solid	3	Anlr.LevelA	Left

X241y(2K ohms) Frequency Response ALL 4 CHANNELS TOGETHER - STEP 10  
 0=CYAN, 1=GREEN, 2=YELLOW, 3=RED  
 1.4vp20Hz to 200kHz on chan 3  
 AP2 Input Z = 100k ohms,  
 MB PWR



# Application Note

## Appendix

Audio Precision XICOR X9241 ALL CHANS Frequency Response

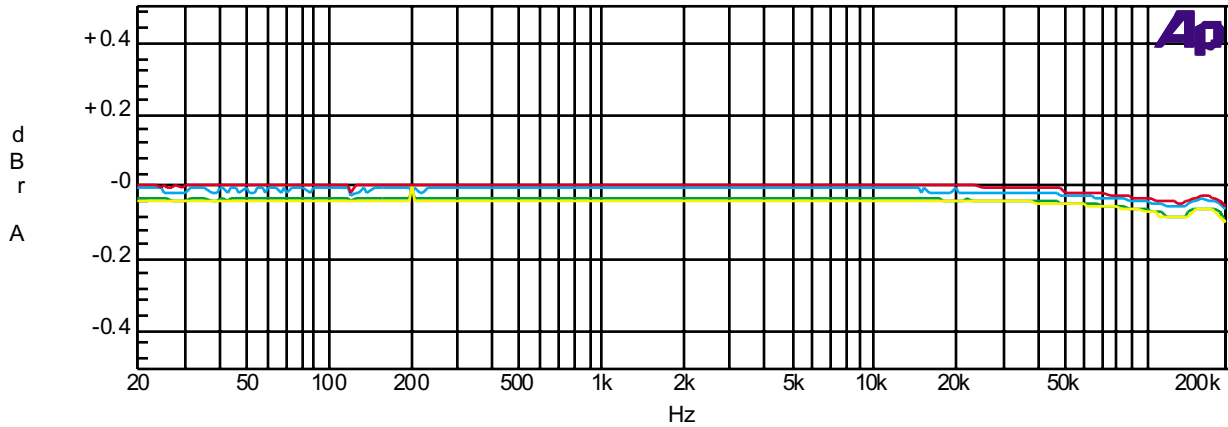

Color	Line Style	Thick	Data	Axis
Cyan	Solid	3	Anr.LevelA	Left
Green	Solid	3	Anr.LevelA	Left
Yellow	Solid	3	Anr.LevelA	Left

X241y(2K ohms) Frequency Response ALL 4 CHANNELS TOGETHER  
 0=CYAN, 1=GREEN, 2=YELLOW, 3=RED  
 1.4vp20Hz to 200kHz on chan 3 @ step 63  
 AP2 Input Z = 100k ohms,  
 MB PWR

**X9408-Total Harmonic Distortion + Noise vs. Input Voltage & DCP Position**

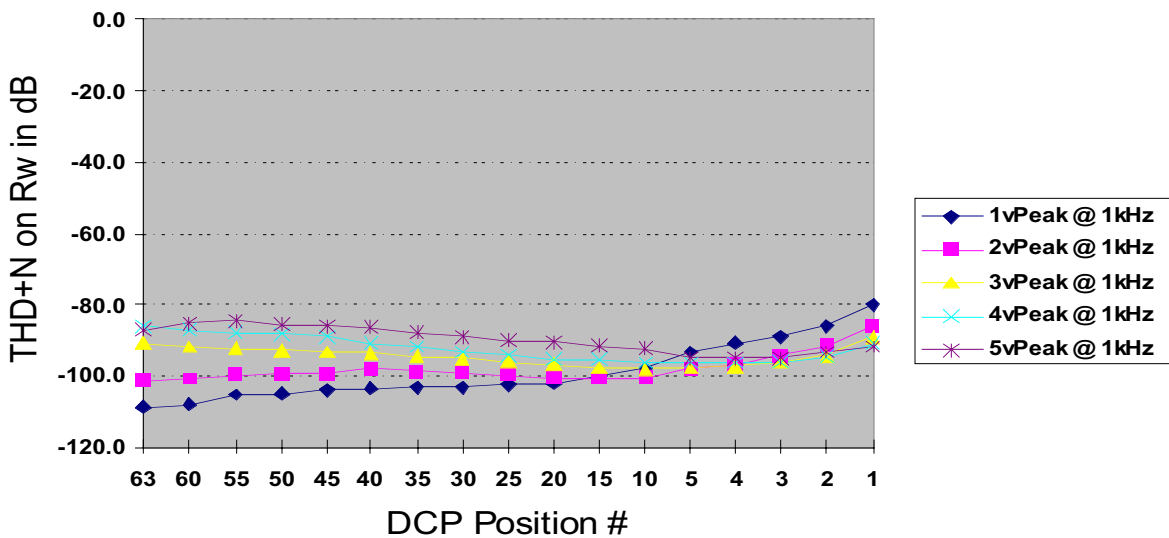



## Low Noise/Low Power/2-Wire Bus

# X9408

## Quad Digitally Controlled (XDCP™) Potentiometers

### FEATURES

- Four potentiometers in one package
- 64 resistor taps per potentiometer
- 2-wire serial interface
- Wiper resistance, 40Ω typical at 5V
- Four nonvolatile data registers for each pot
- Nonvolatile storage of wiper position
- Standby current < 1μA max (total package)
- V<sub>CC</sub> = 2.7V to 5.5V operation  
V<sub>+</sub> = 2.7V to 5.5V  
V<sub>-</sub> = -2.7V to -5.5V
- 10KΩ, 2.5KΩ end to end resistances
- High reliability
  - Endurance—100,000 data changes per bit per register
  - Register data retention—100 years
- 24-lead SOIC, 24-lead TSSOP, and 24-lead XBGA packages

### DESCRIPTION

The X9408 integrates four digitally controlled potentiometers (XDCP) on a monolithic CMOS integrated circuit.

The digital controlled potentiometer is implemented using 63 resistive elements in a series array. Between each element are tap points connected to the wiper terminal through switches. The position of the wiper on the array is controlled by the user through the SPI bus interface. Each potentiometer has associated with it a volatile Wiper Counter Register (WCR) and four non-volatile Data Registers that can be directly written to and read by the user. The contents of the WCR controls the position of the wiper on the resistor array through the switches. Powerup recalls the contents of the default data register (DR0) to the WCR.

The XDCP can be used as a three-terminal potentiometer or as a two terminal variable resistor in a wide variety of applications including control, parameter adjustments, and signal processing.

### BLOCK DIAGRAM

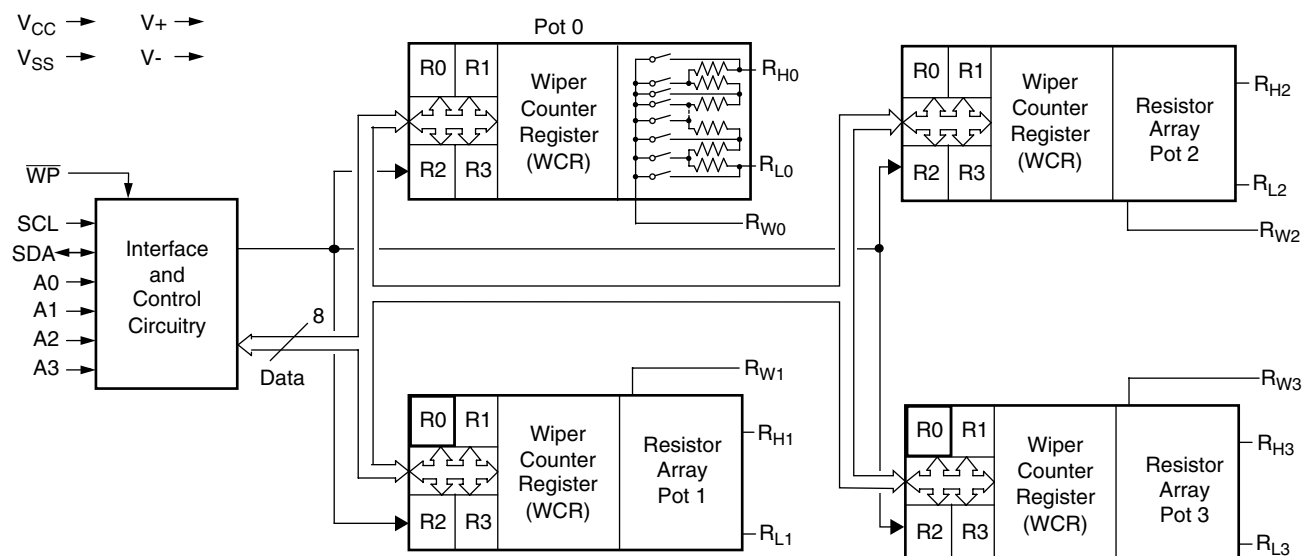





## Terminal Voltages $\pm 5V$ , 100 Taps

# X9C102/103/104/503

## Digitally Controlled Potentiometer (XDCP™)

### FEATURES

- Solid-state potentiometer
- 3-wire serial interface
- 100 wiper tap points
  - Wiper position stored in nonvolatile memory and recalled on power-up
- 99 resistive elements
  - Temperature compensated
  - End to end resistance,  $\pm 20\%$
  - Terminal voltages,  $\pm 5V$
- Low power CMOS
  - $V_{CC} = 5V$
  - Active current, 3mA max.
  - Standby current, 750 $\mu A$  max.
- High reliability
  - Endurance, 100,000 data changes per bit
  - Register data retention, 100 years
- X9C102 = 1 k $\Omega$
- X9C103 = 10 k $\Omega$
- X9C503 = 50 k $\Omega$
- X9C104 = 100 k $\Omega$
- Packages
  - 8-lead SOIC and DIP

### DESCRIPTION

The X9Cxxx are Xicor digitally controlled (XDCP) potentiometers. The device consists of a resistor array, wiper switches, a control section, and nonvolatile memory. The wiper position is controlled by a three-wire interface.

The potentiometer is implemented by a resistor array composed of 99 resistive elements and a wiper switching network. Between each element and at either end are tap points accessible to the wiper terminal. The position of the wiper element is controlled by the  $\overline{CS}$ , U/D, and  $\overline{INC}$  inputs. The position of the wiper can be stored in nonvolatile memory and then be recalled upon a subsequent power-up operation.

The device can be used as a three-terminal potentiometer or as a two-terminal variable resistor in a wide variety of applications including:

- control
- parameter adjustments
- signal processing

### BLOCK DIAGRAM

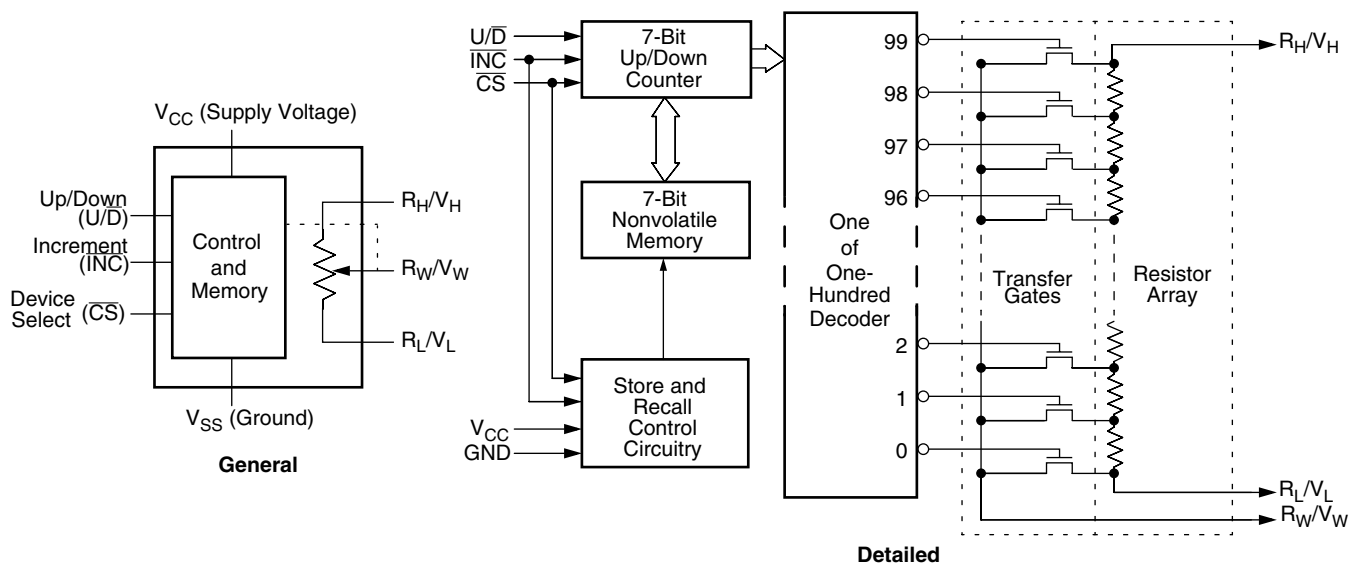



# Application Note

---

Xicor, Inc., the Xicor logo, E2POT, XDCC, XBGA, AUTOSTORE, Direct Write cell, Concurrent Read-Write, PASS, MPS, PushPOT, Block Lock, IdentiPROM, E2KEY, X24C16, SecureFlash, and SerialFlash are all trademarks or registered trademarks of Xicor, Inc. All other brand and product names mentioned herein are used for identification purposes only, and are trademarks or registered trademarks of their respective holders.

Xicor Incorporated, 1511 Buckeye Drive, Milpitas, California 95035-7493



LittleDiode supplies new, hard to find or obsolete electronic components and semiconductors all over the world.

With over two million different components listed you are sure to find the part you need.

Feel free to visit us today at our online store:

[LittleDiode.com](http://LittleDiode.com)

Looking forward to providing you with the best possible service.