

X3100 Voltage Measurement Accuracy

Description

This test measures the accuracy of the cell voltage measurement circuits of the X3100. In the test, a known voltage is applied across each cell input of the X3100. The analog output voltage of the X3100 is measured for each cell. This value is compared to the input voltage. The collected data includes the values from three devices from three different lots. The data also includes tests at 0°C, 25°C and 50°C.

Test Setup

For this test, Vcc was held at 16V to prevent the device entering the sleep mode when testing cell voltages below 2V. In the test 4V was applied to all cells, except the cell being measured. The voltage was applied at 10mV intervals over four ranges. These input ranges were 1.5 to 1.7V, 2.5 to 2.7V, 3.5 to 3.7V and 4.0 to 4.2V.

Figure 1. Cell Voltage Measurement

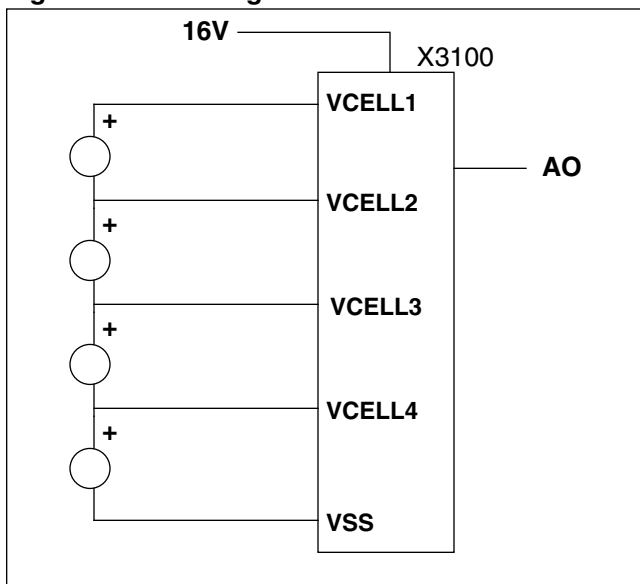

For each cell and each applied voltage the output was recorded. This involves the changing of the analog multiplexer setting in the X3100. In gathering the data

with this test, the output was sample. This procedure was used to reduce the effect of external noise on the test environment.

Results

The data for this test is available in raw form in an Excel spreadsheet. This spreadsheet includes data for each device, data for each lot, and data for all devices. Each set of data includes results for the three temperature settings and the four gain settings. The data was copied to other files for the purposes of generating graphs.

The result summaries show the output error as a percentage. This error is provided for each of 3 lots as well as the combined data. Data is averaged, and standard deviation computed, from samples taken at three temperatures 0°C, 25°C and 50°C.

On the following charts, absolute error is the Output minus the Input, while the percent error is calculated as follows:

$$Error = \frac{Output - Input}{Input}$$

Overall Performance

The following set of graphs shows the performance of the X3100 over temperature and across three lots of three devices. The graphs will show the basic input/output curve, raw error, and error after correction for offset and gain.

The below data shows that the X3100 output is accurate, with 3 standard deviations, to better than 2.5% error across all measured voltages. It also shows that over the key range of 2.5 to 4.2V, accuracies of better than 1% can be expected. These accuracies are not dependent on any calibration factors.

Figure 2. Characterization Test Setup

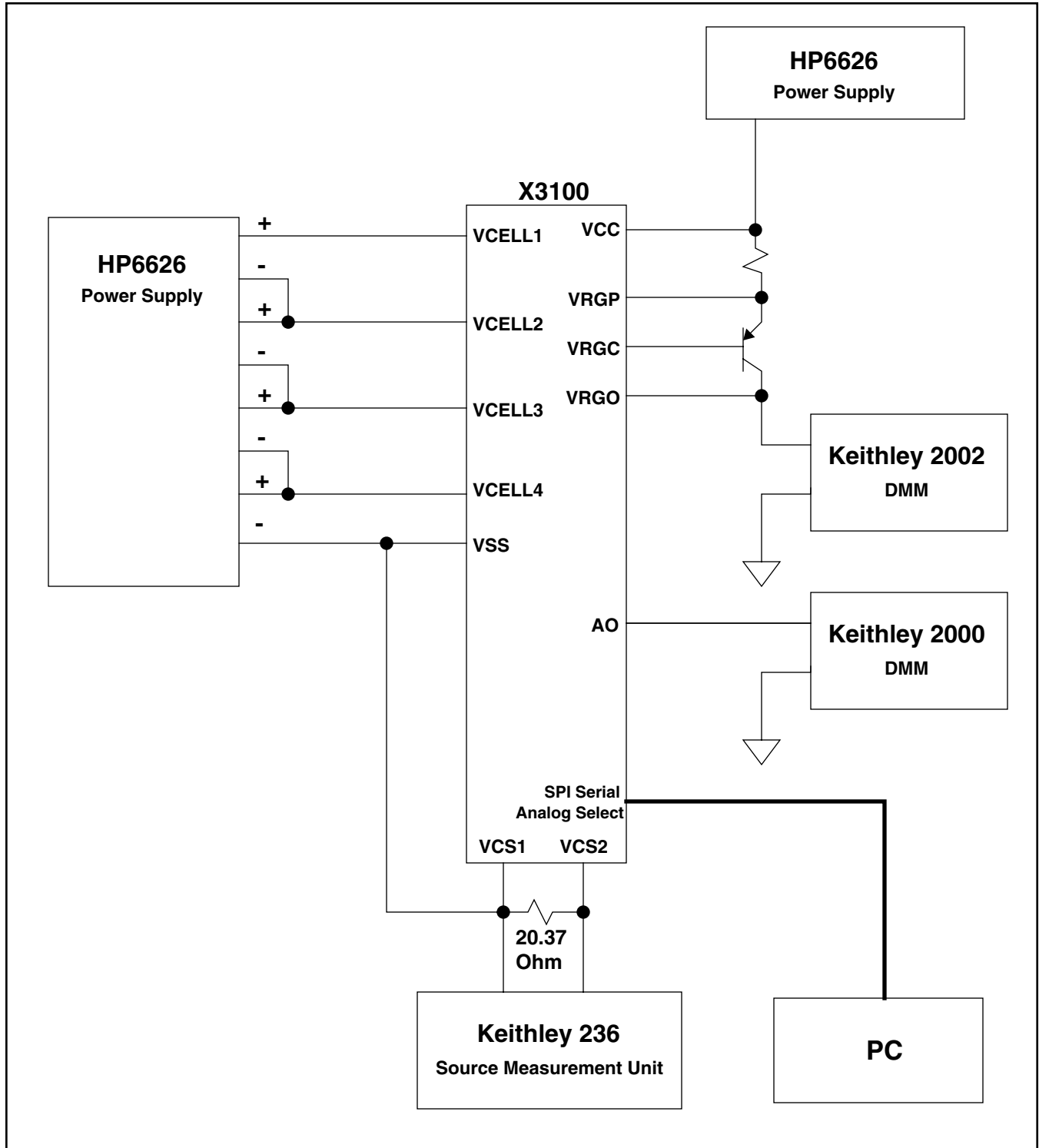

Lot 1

1. Input to output voltage error - Cell 1

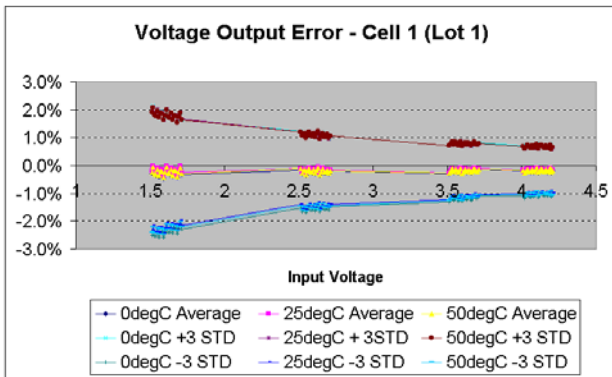
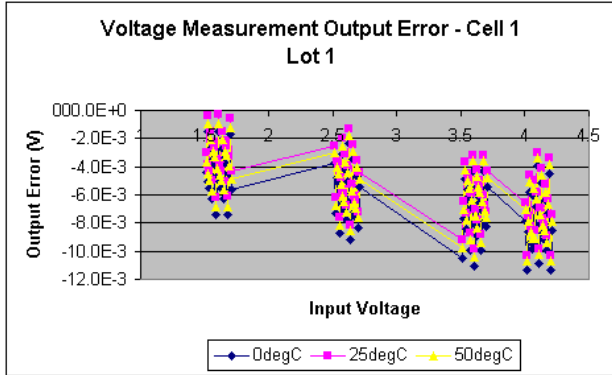

2. Input to output voltage error - Cell 2.

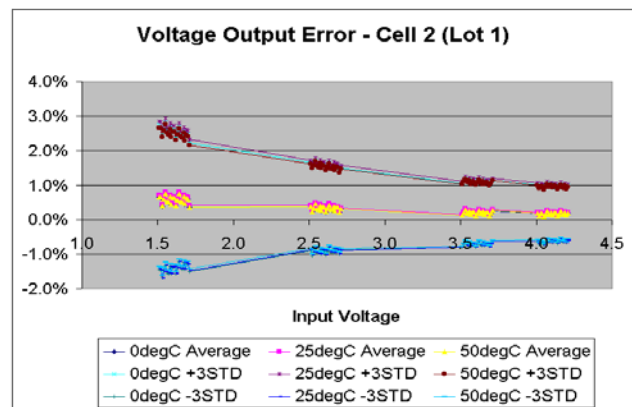
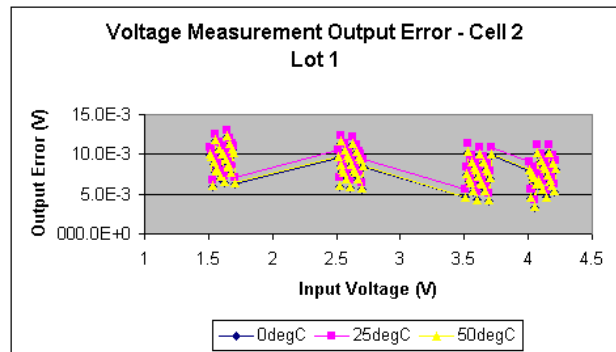

3. Input to output voltage error - Cell 3.

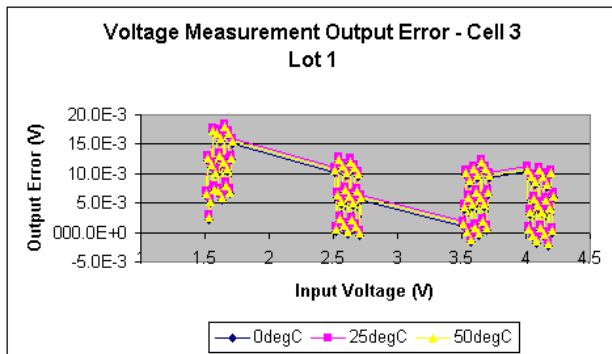

4. Input to output voltage error - Cell 4.

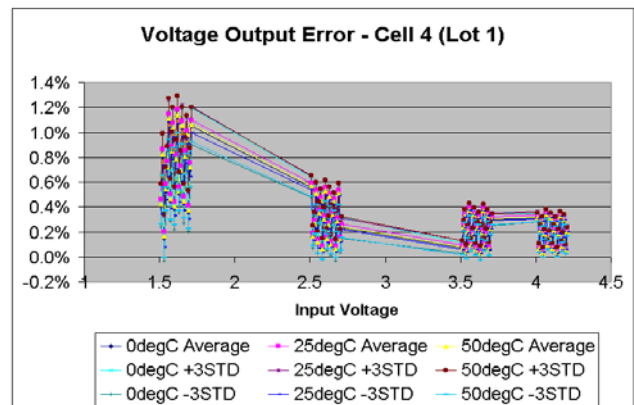
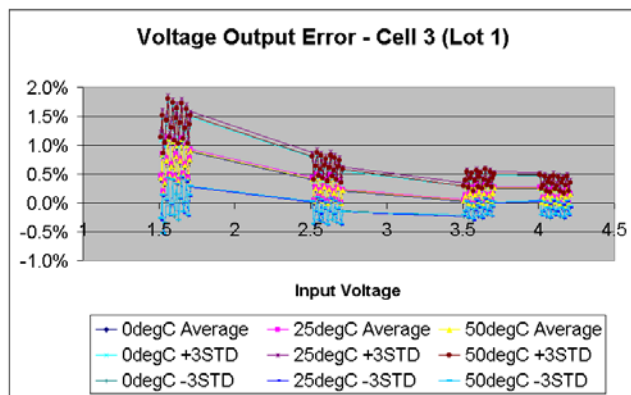
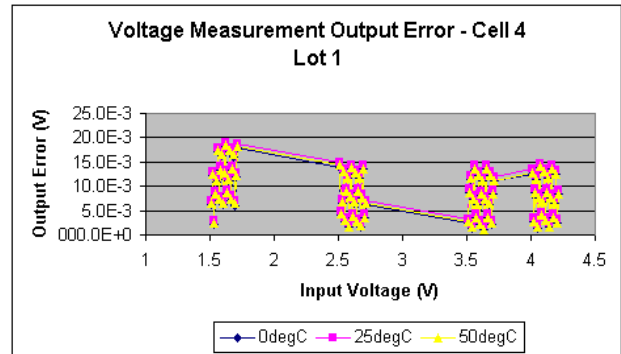

Lot 2

5. Input to output voltage error - Cell 1

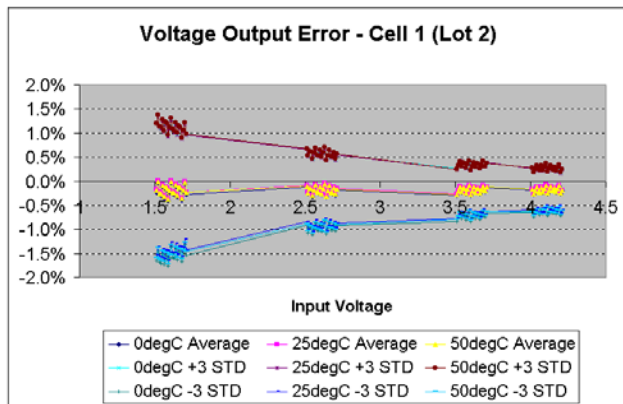
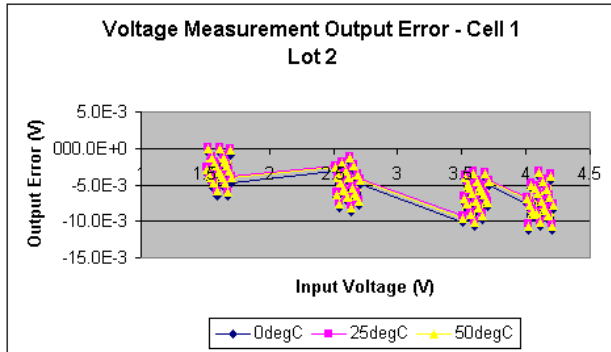

6. Input to output voltage error - Cell 2

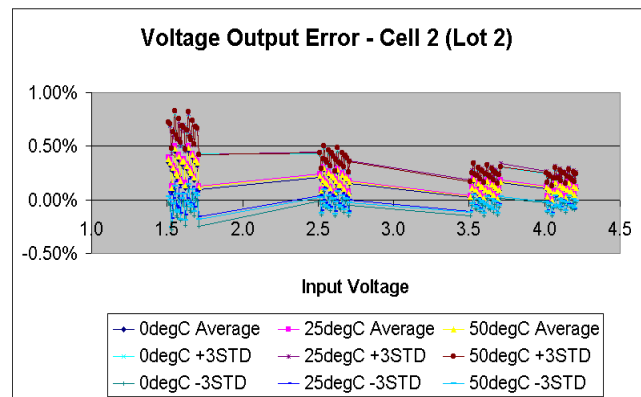
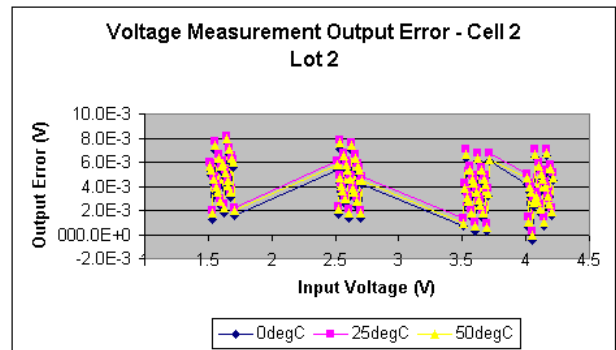

7. Input to output voltage error - Cell 3

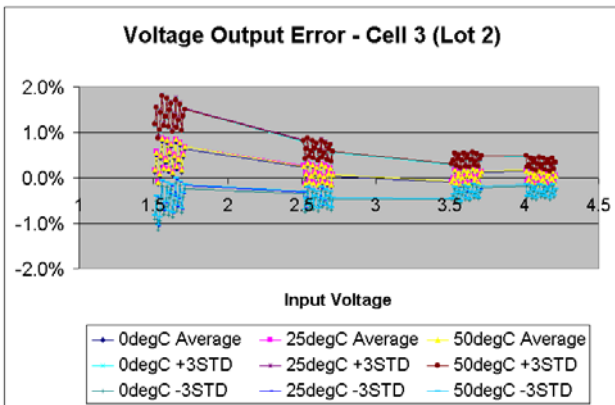
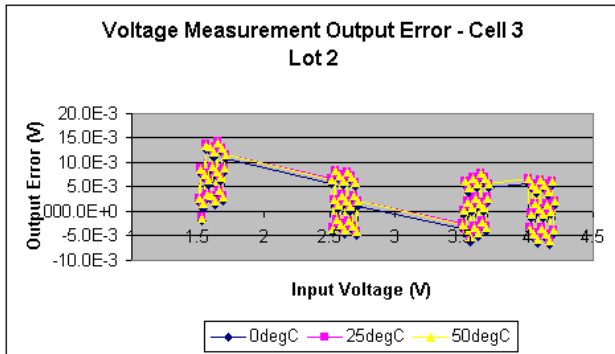

8. Input to output voltage error - Cell 4

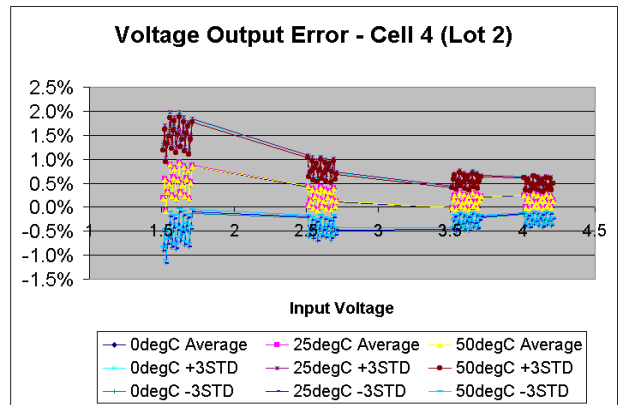
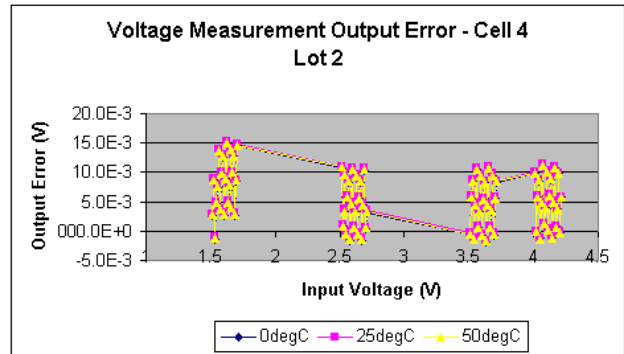

Lot 3

9. Input to output voltage error - Cell 1.

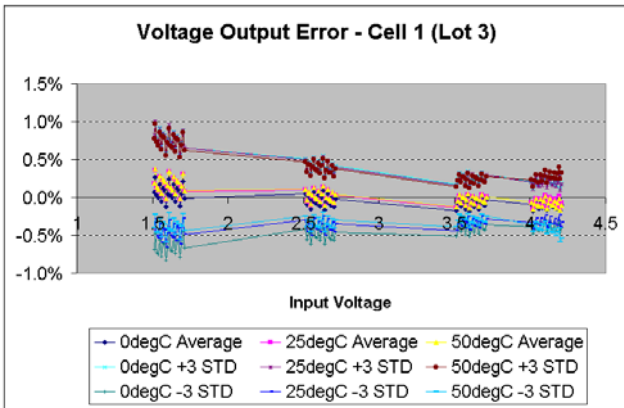
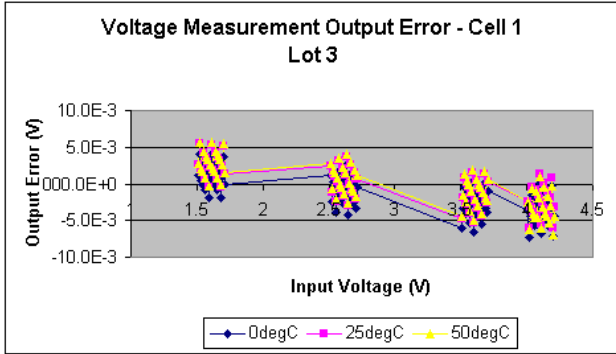

10. Input to output voltage error - Cell 2.

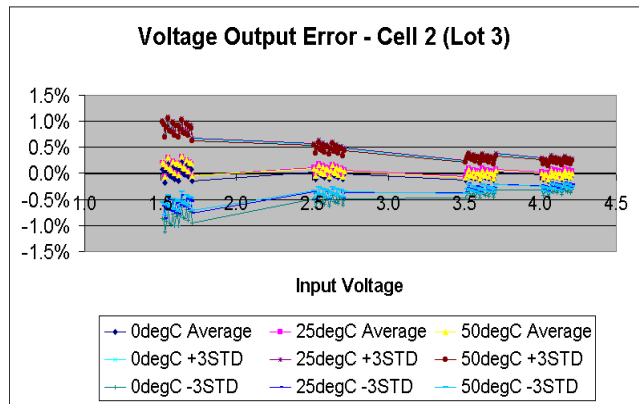
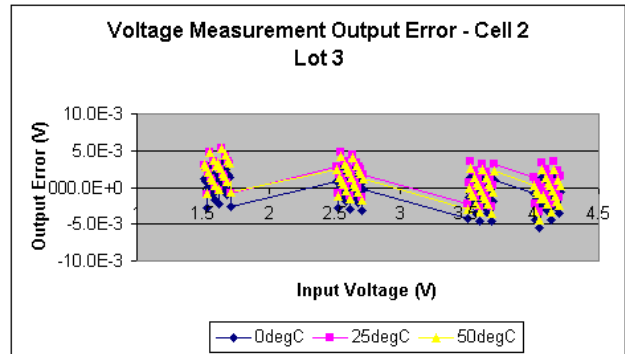

11. Input to output voltage error - Cell 3.

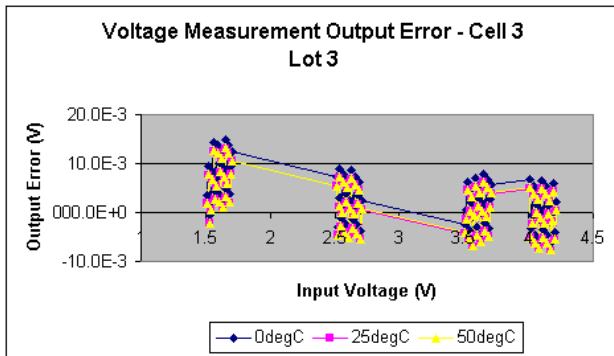

12. Input to output voltage error - Cell 4

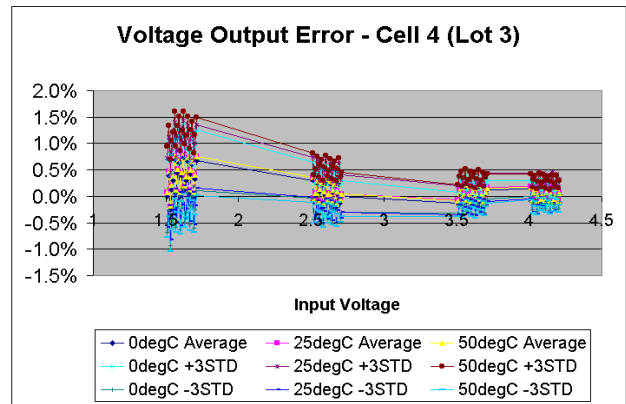
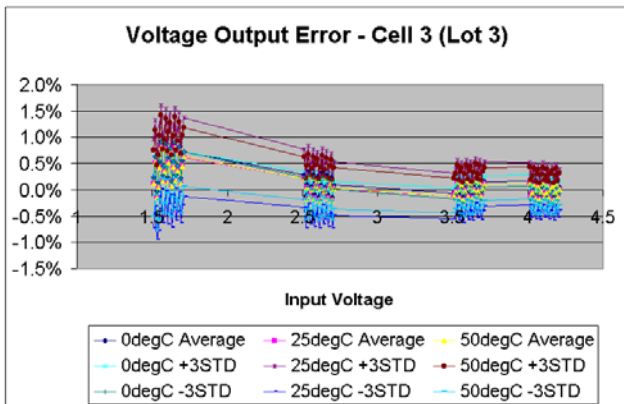
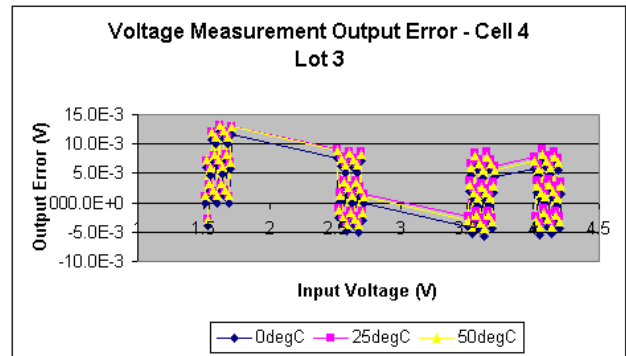

Combine All Lots

13. Input to output voltage error - Cell 1.

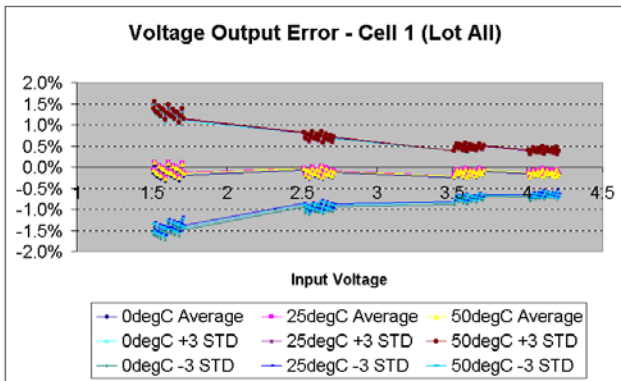
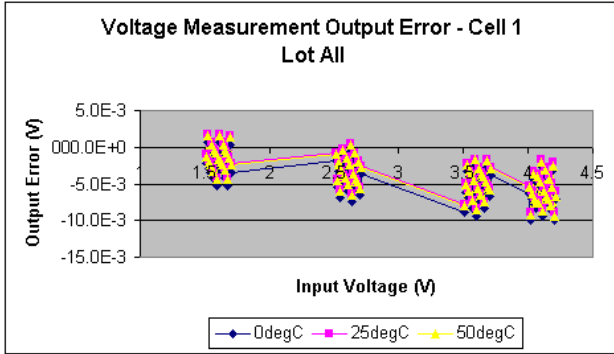

14. Input to output voltage error - Cell 2.

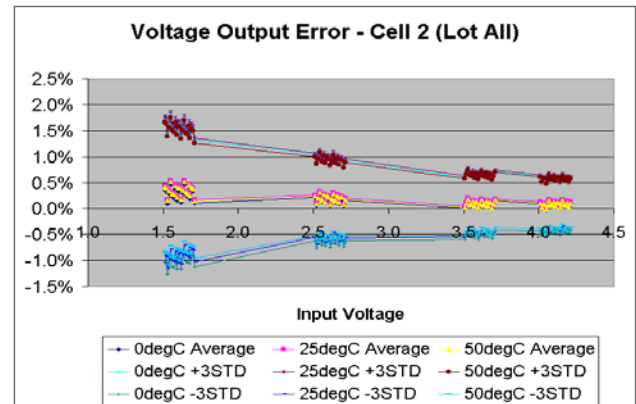
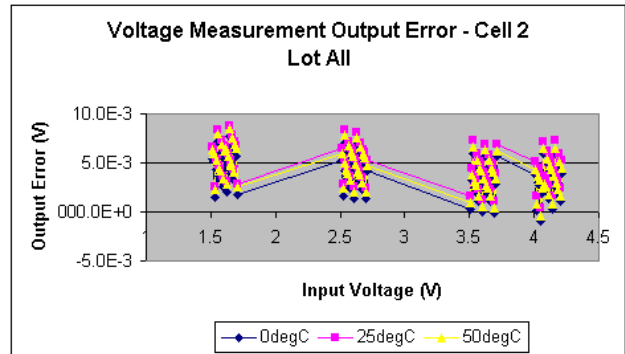

15. Input to output voltage error - Cell 3.

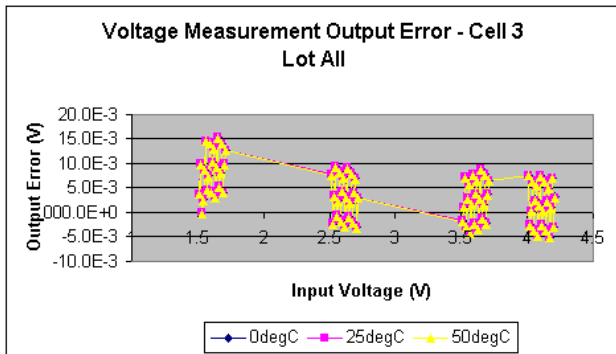

16. Input to output voltage error - Cell 4.

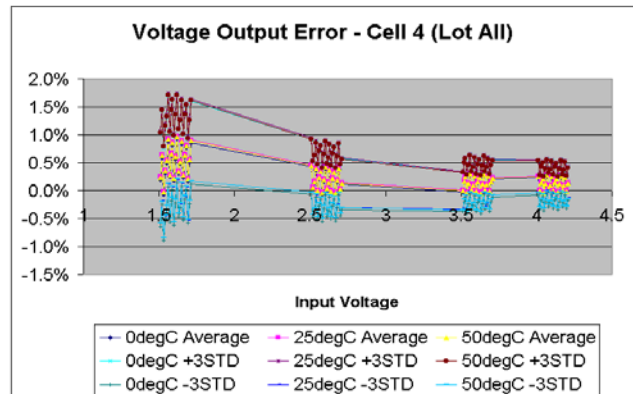
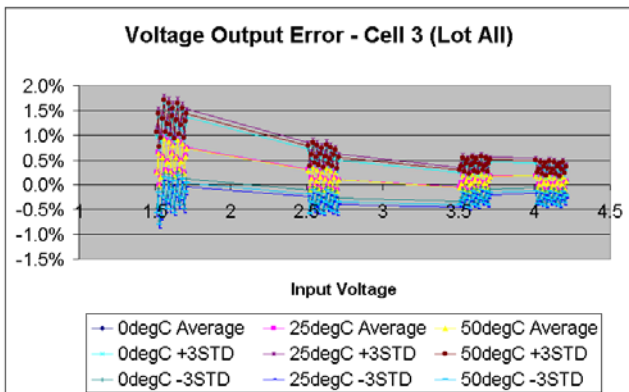
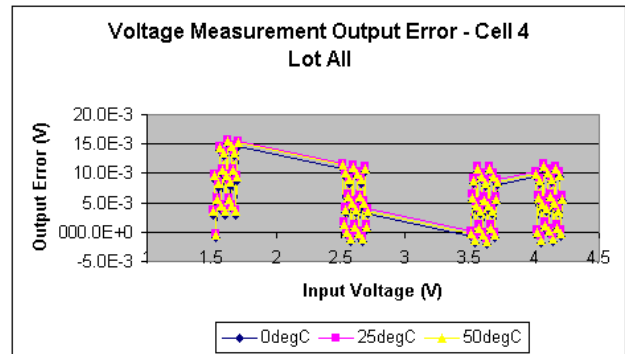

Xicor, Inc., the Xicor logo, E2POT, XDCCP, XBGA, AUTOSTORE, Direct Write cell, Concurrent Read-Write, PASS, MPS, PushPOT, Block Lock, IdentiPROM, E2KEY, X24C16, SecureFlash, and SerialFlash are all trademarks or registered trademarks of Xicor, Inc. All other brand and product names mentioned herein are used for identification purposes only, and are trademarks or registered trademarks of their respective holders.



LittleDiode supplies new, hard to find or obsolete electronic components and semiconductors all over the world.

With over two million different components listed you are sure to find the part you need.

Feel free to visit us today at our online store:

LittleDiode.com

Looking forward to providing you with the best possible service.