



SINGLE-PHASE INDUCTION MOTOR DRIVE FOR REFRIGERATOR COMPRESSOR APPLICATION

1. INTRODUCTION

Up to now, refrigerator compressors have been controlled by electromechanical switches (thermostat or even electronically controlled relays). This choice was driven by the high inrush current that can appear when the rotor is stalled. Furthermore, electromechanical relays are advantageous because they are less sensitive to line voltage disturbances. Today, new semiconductor devices feature over-voltage protection and high inrush current capability, allowing them to be used in cold appliances.

Electronic thermostats can so be implemented, allowing the appliance efficiency to be improved by more than 20 W, for 150 W compressors, thanks to better temperature control and the removal of the PTC.

Hence, at a similar cost as Electromechanical thermostats, this technical breakthrough could allow refrigerators or freezers to fulfill Class A consumption requirements, bringing the following advantages:

- Better reliability:
 - Higher switching robustness of static switches towards mechanic solutions
 - Higher ACS and ACST overvoltage robustness towards Triacs, which allows Metal-Oxide varistor removal
- Temperature regulation law flexibility (automatic defrost, Hysteresis threshold adaptation)
- Reduction of the temperature ripple (better food preservation, appliance elements downsizing)
- Possibility to add indication features for the end-user (inside temperature, open door)
- Spark-free operation and EMI reduction (switches can be turned on at Zero Voltage and are turned off at Zero Current)
- Overcurrent protection of the motor winding.

This paper outlines the different topologies that can be used for electronic motor control, and lists the electrical constraints that result from these different circuits. A comparison is also made between the different performances of electromechanical or electronic thermostats.

All numerical examples are based on the specifications for a 1/5 Horse power compressor, which can be used in 350 L freezers

2. SINGLE-PHASE INDUCTION MOTOR DRIVE TOPOLOGIES

2.1 One or Two Triac approach

Single-phase induction motors, used for compressor controls, embed an auxiliary winding. This winding permits a higher torque at start-up to be applied. Two different ways can be implemented to control this auxiliary winding. The different topologies are given in Figures 1 and 2.

The most popular method is to add a Positive Temperature Coefficient (PTC) resistor in series with this coil and the thermostat (cf. Figure 1). Then, each time the thermostat is closed, the current flows through the Start winding and begins to heat the PTC. After a few hundreds of milliseconds, the PTC value rapidly increases from a few Ohms to several tens of kOhm. This results in reducing the Start winding current to a few tens of mAmps. This winding can then be considered as open.

A second solution is to use a second triac to control the auxiliary winding and then replace the PTC duty (cf. Figure 2). Then, at START Triac OFF state, no power is consumed contrary to the PTC, this results in an improvement in the appliance efficiency (cf. 4.2.1 section).

APPLICATION NOTE

A start capacitor is sometimes connected in series with this winding in place 1 (cf. Figures 1 and 2). It is important to note, even for the same motor, that this capacitor can be placed or removed, without disturbing the motor operation.

When C is placed in Position 2 (split-phase capacitor), it always sinks a current, even when the PTC is hot or when the START triac is OFF. This allows power factor improvement and power consumption reduction. In fact, the C capacitor will be added if the refrigerator or freezer does not reach the required efficiency level without it.

In the following study, we assume that C is always placed at Position 2, if present.

Fig. 1: One-triac topology

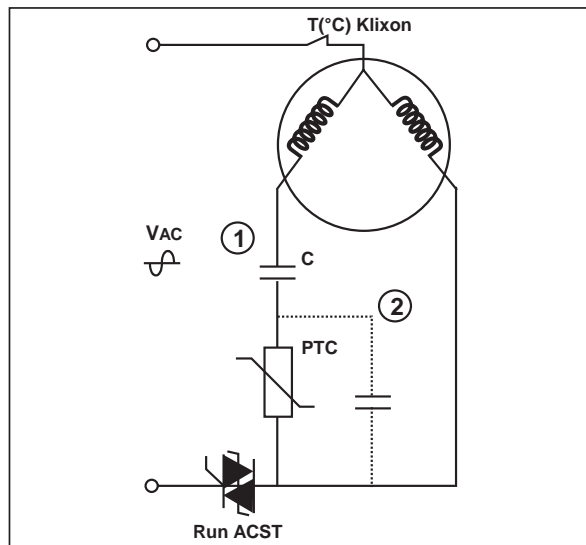
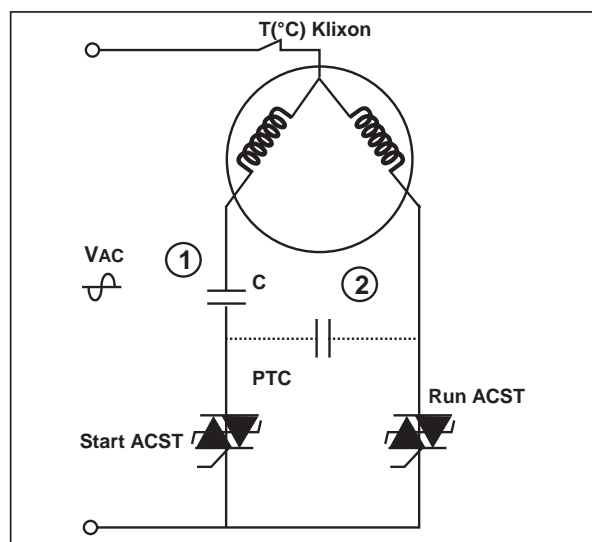

Fig. 2: Two-triac topology



2.2 Semiconductor rating

2.2.1 Start-capacitor voltage

The start capacitor and the auxiliary winding form a resonant R-L-C circuit. The capacitor voltage can thus be higher than the mains one. In practice the ratio between V_C and V_{ac} equals 1.1 to 1.5.

The worst case appears at the run triac turn-off, for both topologies. Indeed, V_C is added to the mains voltage up to the capacitor complete discharge. This results in high voltages across the run triac (cf. Figure 3).

Even for a 220-240 V application, 700 V semiconductors must then be chosen.

Fig. 3: Voltage across run triac after turn-off (612V max)

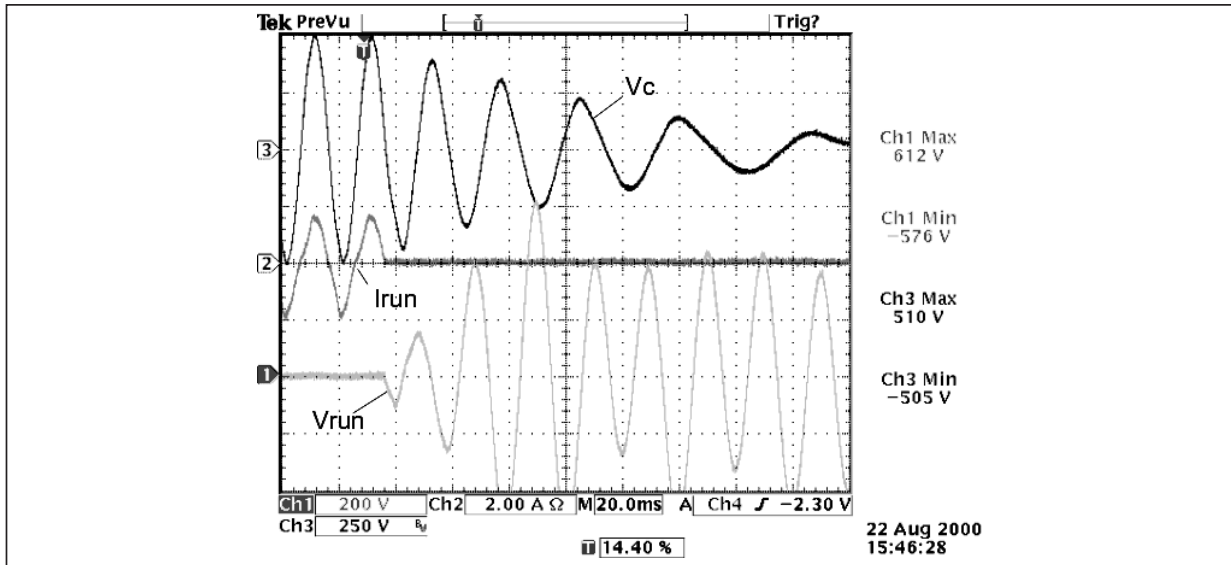

2.2.2 Current rating

Refrigerator or freezer compressors mostly feature input power in the range of 100-300 W. The steady state current is then in the range of 0.5 to 3 A RMS for a 220-240 V mains voltage.

The highest current appears at start-up and can reach up to 4 times the steady state current. Thermal calculations can demonstrate that, as these events last a short time, 6 A devices can be used without any heat sink. For example, Figure 4 gives the junction temperature increase of an ACST6-7ST without any heat sink, due to the inrush current which is measured through the start winding of a 1/5 Horse power compressor. It shows that T_j only reaches 72 °C, when coming from a 60 °C ambient temperature, and remains below the maximum allowed temperature (125 °C).

Fig. 4: Inrush current in START winding (1/5 Horse power compressor)

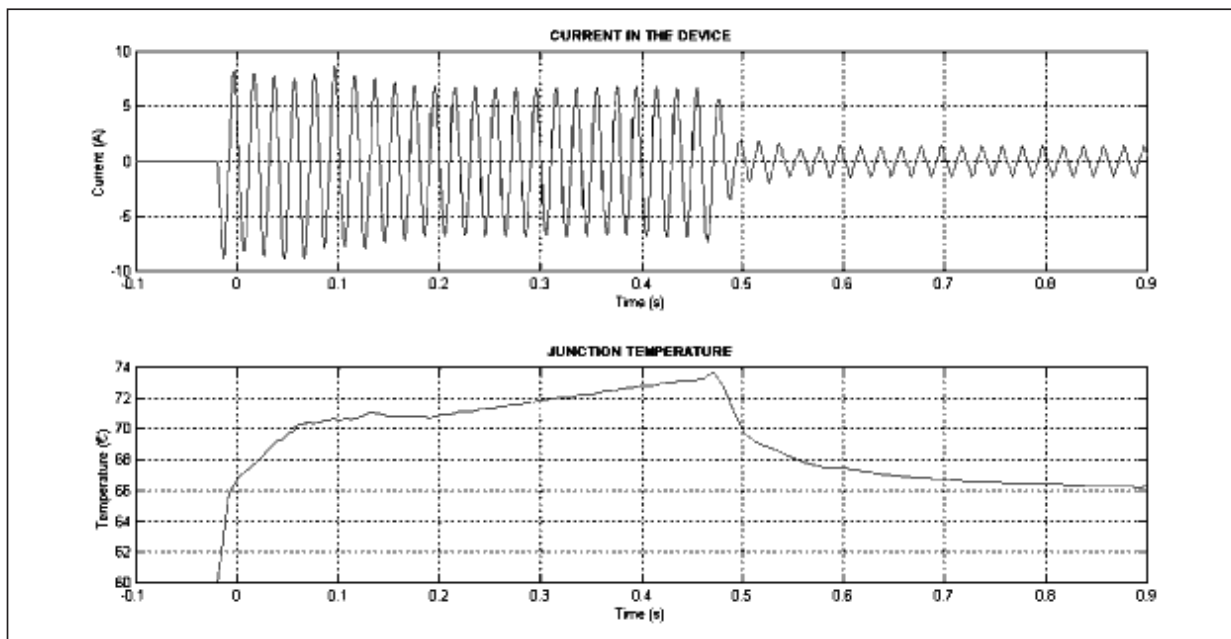

APPLICATION NOTE

When dealing with the current rating for AC semiconductor switches, the rate of decrease of the current must also be checked. This constraint will depend on the chosen topology.

The worst case of turn-off stress appears with a compressor without any start capacitor. In this case, the rise in voltage will not be slowed by the motor capacitor. The higher stress occurs for the “START” winding (where the impedance is lower than the “RUN” winding one) and when the rotor is stalled. These two conditions yield a higher current and therefore, a higher rate of decrease for the ACST current.

Then, for a stalled 1/5 Horse power compressor, supplied with a 264 V RMS voltage, the di/dt and dV/dt equals respectively 2.4 A/ms and 9.6 V/ μ s through the START ACST (cf. Figure 5, measured with THERM01EVAL board). This is far below the maximum withstanding for ACST6 devices, which is 3.5 A/ms with a 15 V/ μ s rate.

Fig. 5: Turn-off constraint for the worst case scenario

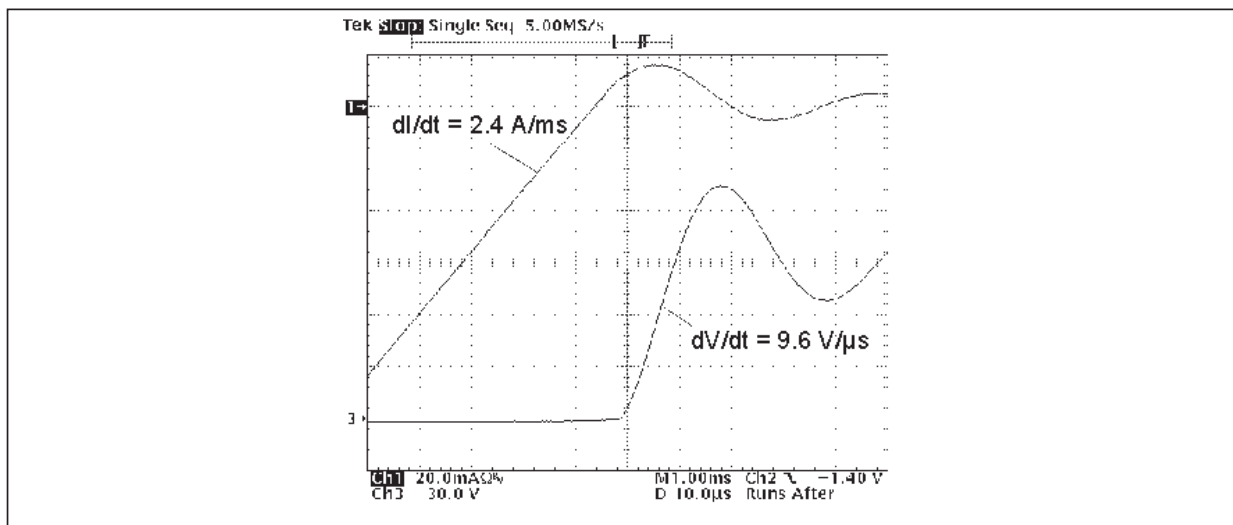

2.3 Protective inductor

With the two-triac topology, a spurious discharge of the start-capacitor can occur when the start-triac is accidentally turned on. To reduce the di/dt stress through the silicon switch, a small protective inductor can be added in series with this triac.

In order to optimize the solution cost, this inductor can be achieved in Printed Circuit Board (PCB). For example, a double-sided inductor with 12 turns of 0.51 mm width track (cf. Figure 6), made on a 35 μ m-FR4 PCB, yield to a 5 μ H – 1.6 Ohm resistor.

An inductor as described in Figure 6, allows the di/dt rate to be limited, in case of a spurious firing of the START ACST when the RUN ACST is already on, below 60 A/ μ s (start capacitor is charged up to 510 V). The semiconductor device operation is then well secured.

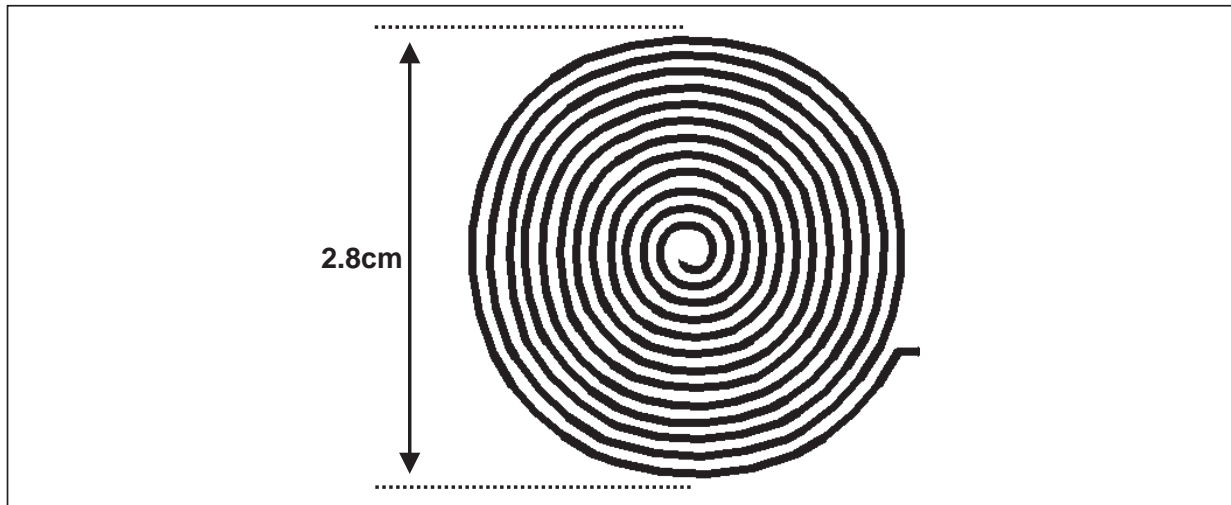
Fig. 6: 5 μ H PCB inductor

3. STALLED ROTOR MANAGEMENT

3.1 Protection by thermal cut-off

In the case of a stalled rotor operation, the over current protection is commonly ensured by a thermal cut-off. This component, also called “klixon”, is mandatory to prevent the compressor from over-heating. Klixons are well adapted for motor protection, but not for semiconductors. Indeed, the turn-off time is in the range of 15 s. The silicon switch will withstand a high current that will only decrease thanks to the motor winding heating. In practice, the RMS current can fall from 9 A RMS to around 4.5 A RMS, for a 1/5 horse power compressor.

The maximum junction temperature reached by the ACST6-7ST can then equal 160 °C as shown by the simulation results in Figure 7.

As this temperature exceeds the maximum allowed steady state temperature of the triac (125 °C), reliability tests have been performed to check the robustness of the silicon switches after such stress. ACST6 devices can then withstand such currents up to more than 10 thousand times. This easily covers the number of stalled rotor operations that can happen during the life cycle of a refrigerator or freezer.

Fig. 7: Triac junction temperature during stalled rotor operation

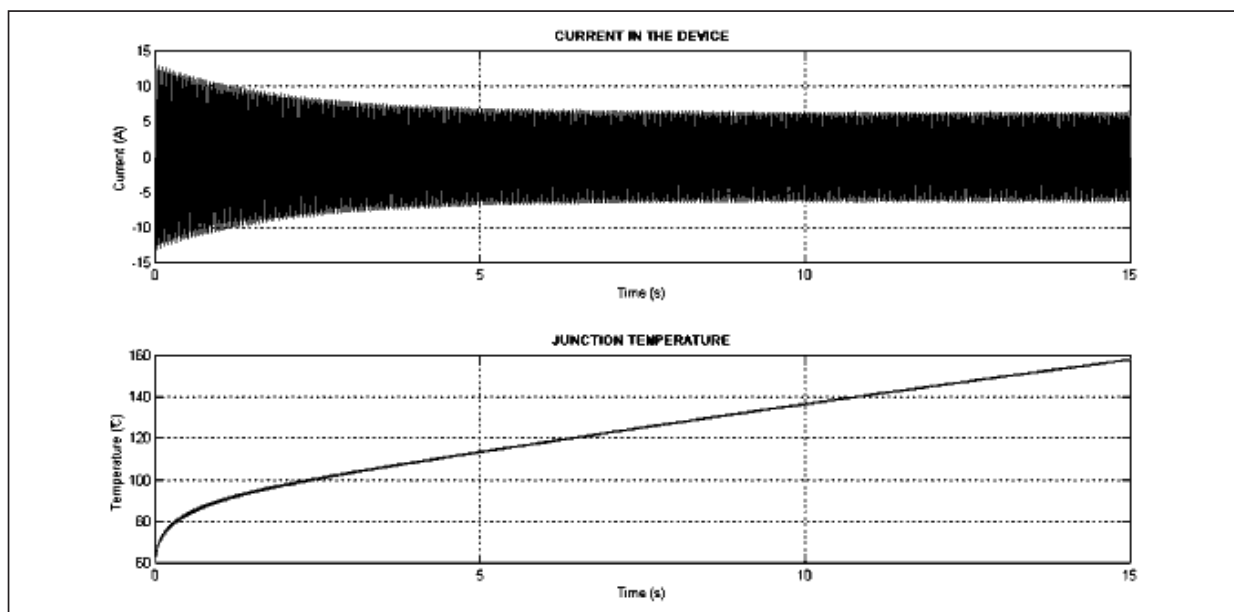

APPLICATION NOTE

3.2 Protection by microcontroller

In order to secure the life expectancy of a refrigerator, the stalled rotor protection can also be achieved by the electronic board. In this case, the over-current is applied to the motor and the switches for less than 1 s, as opposed to 15 s with a thermal cut-off. The maximum junction temperature will then reach 85 °C, for a 60 °C ambient temperature, instead of 160 °C, eliminating any stress on the ACST.

This 1 s duration is chosen in order to differentiate an abnormal over-current from the starting one, as explained below.

To sense an over-current, it is possible to measure the voltage across a shunt resistor placed in series with the RUN ACST. Then, as the current is alternative, it must be clearly defined at which moment it must be measured. Furthermore, this moment must be chosen in order to differentiate the over-current from the normal current. Figure 8 gives the maximum and minimum currents for both operating conditions. These curves come from experimental results where the mains voltage has been varied from 198 to 264 V RMS, with and without a start capacitor.

Figure 8 shows that, in a stalled rotor condition, the current is still above 5.6 A between 6 and 8 ms after Zero Voltage Crossing. In normal condition, the load current is always lower than 3 A at this moment.

The 5.6 A value is chosen as the limit to consider that the rotor is stalled. The MCU must then be able to perform A/D conversions between 6 and 8 ms. Several measurements can be done in order to filter measurement noise.

Fig. 8: Motor current maximum ranges

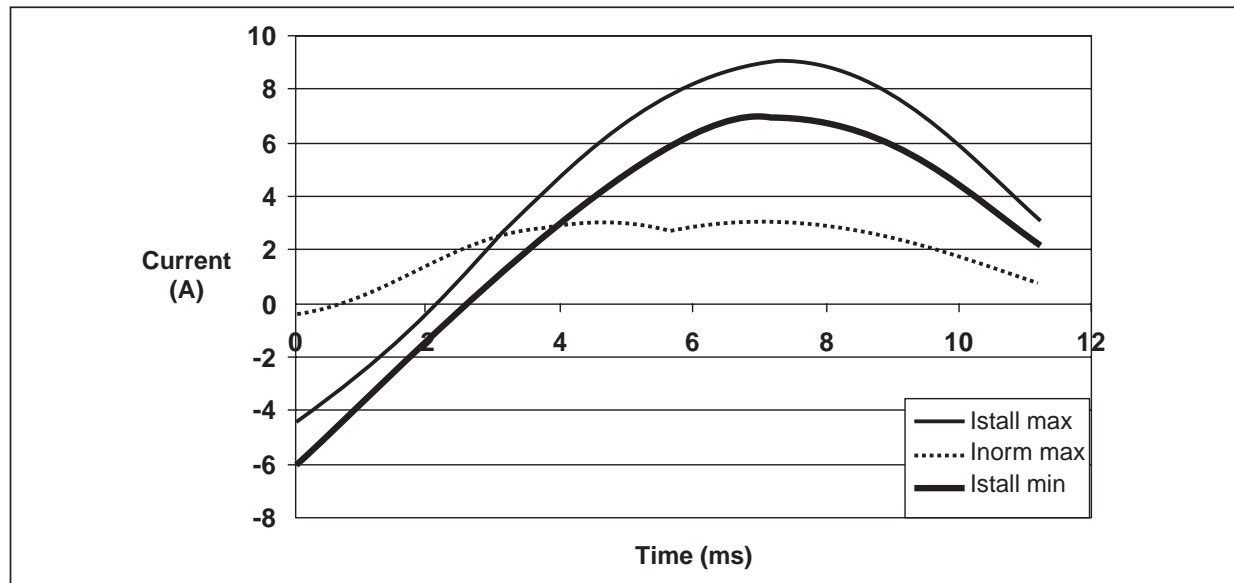

4. ELECTRONIC THERMOSTAT VERSUS MECHANICAL THERMOSTAT

4.1 Temperature regulation

One main advantage of electronic thermostats versus electromechanical ones, is their adaptability. For mechanical thermostats, it is gas compression and decompression that switches the compressor ON or OFF. This does not allow a Hysteresis threshold adaptation during the refrigerator operating cycle. Moreover, this gas effect means that the refrigerator is not ensured to work properly depending on the ambient atmospheric pressure.

For electronic thermostats, the temperature information is measured accurately and at any time, contrary to electromechanical thermostats where the only available information is that the temperature is over a fixed level or not. This enables the temperature fluctuation inside the cabinet to be reduced with electronics.

A reduction of the temperature ripple presents three main advantages:

- Better food preservation
- Thermodynamical efficiency improvement (lower evaporator temperature ripple; higher evaporator minimum temperature; better compressor use cf. paragraph 4.2.2)
- Compressor and evaporator downsizing.

A particularly interesting feature can also be implemented thanks to electronics. Indeed, the Hysteresis levels can be changed during the freezing process. This allows automatic defrosting operations to be implemented. For example, Figure 9 shows that the upper Hysteresis level is increased every 8 cycles in order to let the evaporator temperature become higher than 0°C. This allows the ice deposit on the evaporator to be removed. This may be very helpful to increase refrigerator efficiency as this ice layer plays a real insulation role.

Fig. 9: Temperature fluctuation & defrost cycle with electronic thermostat

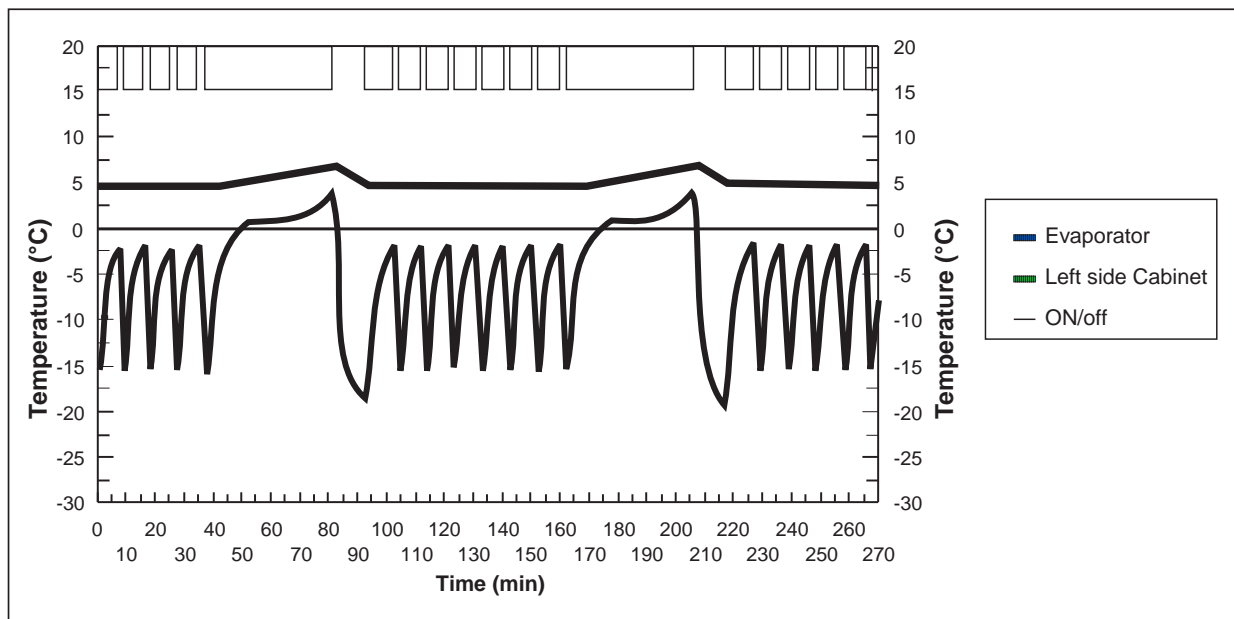

APPLICATION NOTE

4.2 Power consumption

4.2.1 PTC losses

A PTC thermistor presents a very low resistance when it is cold (example: $10\ \Omega$ at $25\ ^\circ\text{C}$). This enables a high inrush current at motor start-up to be applied.

Then, the PTC begins to heat and its impedance rapidly increases. This allows the current to decrease by just a few mAmps, compared to several Amps at the beginning. Figure 10 shows this current at steady state. This figure also gives the dissipated power through the PTC at this moment. It can be said that the PTC continuously absorbs 2.1 W, when the motor is on. This power consumption can be gained simply by removing this component and using two triacs instead of one, to drive the motor.

Fig. 10: PTC power consumption at steady state

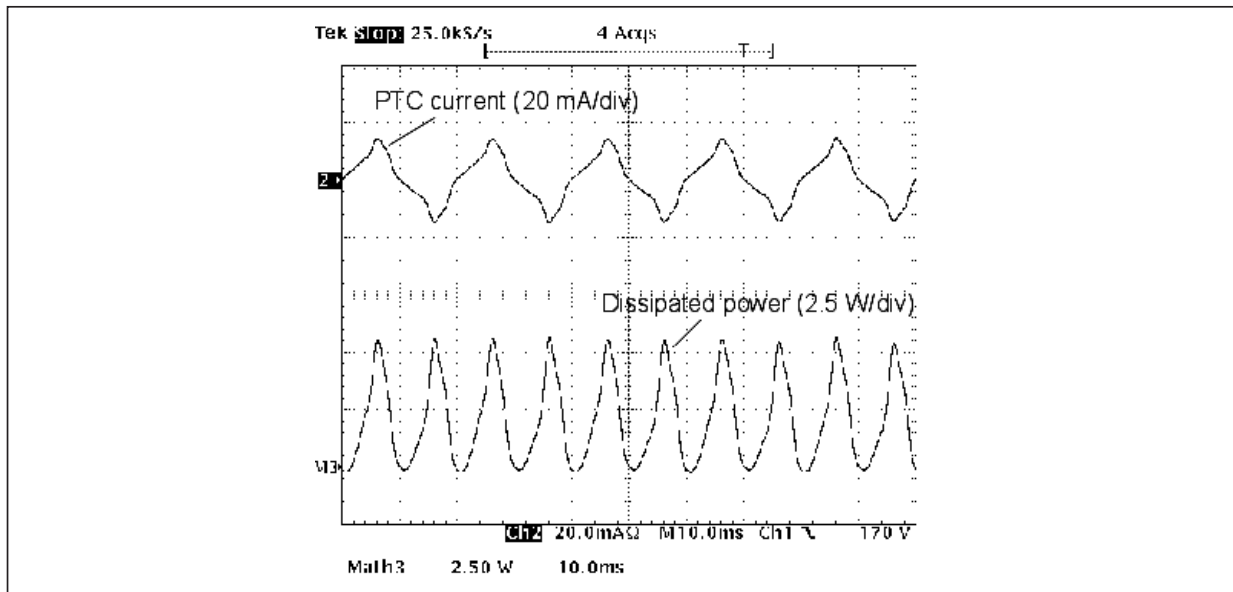

4.2.2 Motor duty cycle

A very efficient way to reduce the power consumption is to control more accurately the temperature.

Some tests have been performed on a half-loaded 350 L freezer, controlled by our electronic thermostat. During the tests, the door is kept closed and the load remains the same.

Figures 11 and 12 give the power consumption and the evaporator and cabinet temperatures for respectively a $5.3\ ^\circ\text{C}$ and $4.2\ ^\circ\text{C}$ control law Hysteresis threshold.

The measurements, shown on Table 1, have been done for the following cases:

- a/ Case 1: Hysteresis Threshold = $5.3\ ^\circ\text{C}$ (similar to mechanical thermostat feature)
- b/ Case 2: Hysteresis Threshold = $4.2\ ^\circ\text{C}$.

Table 1: Power consumption versus Hysteresis threshold

		Case 1 (Hyst. Thres. = 5.3°C)	Case 2 (Hyst. Threh. = 4.2°C)
MEASURE	Compressor ON time	12' 50"	9' 10"
	Compressor OFF time	16' 20"	15' 10"
	Average power during ON time	136 W	138 W
CALCULATION	Cycle period	29' 10"	24' 20"
	Duty cycle	0.44	0.38
	Average power consumption	60 W	52 W

So, it is shown that reducing the temperature ripple improves the appliance efficiency. This is can be explained by the fact that the useful energy is not wasted in vain.

The Case 2 control law enables to save 8 W, just by reducing the threshold level by a little bit more than 1 °C. For electromechanically controlled refrigerators, where the temperature ripple is in the range of 10-20 °C, a decrease down to a few degree Celsius, will enable to save up to 20 % of energy consumption. This means a 18 W saving for a 140 W compressor (90 W average power with a 2/3 duty cycle).

Reducing the temperature ripple changes the compressor behavior. The motor running cycle frequency is increasing. In our example, this frequency increases by around 20 % (2.06 cycles per hour with Case 1, and 2.46 cycles per hour with Case 2). This is not a problem for electronic switches where the cycle length of life is far from the poor capability of electromechanical switches. For the motor point of view, the higher number of cycles should not reduce its reliability as:

- Its temperature ripple is decreased thanks to a higher cycle frequency
- The start winding conduction length is reduced thanks to an electronic control instead of a thermal-active solution (PTC)
- An overcurrent protection is ensured by the MCU, that reduces the motor stress.

Fig. 11 Temperature control (Case 1)

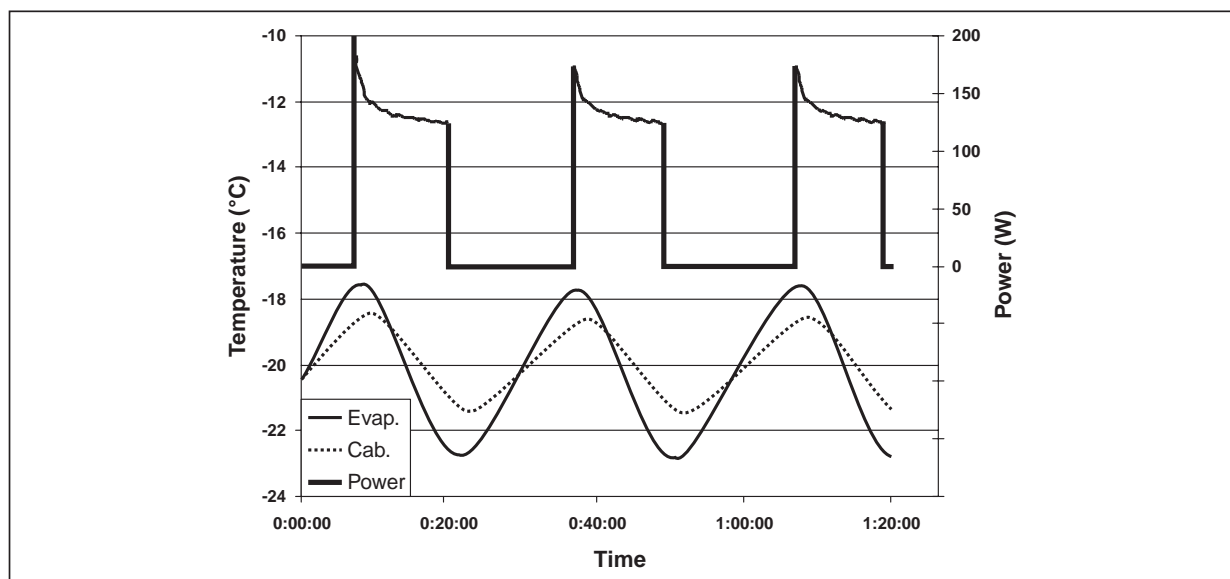

APPLICATION NOTE

Fig. 12: Temperature control (Case 2)

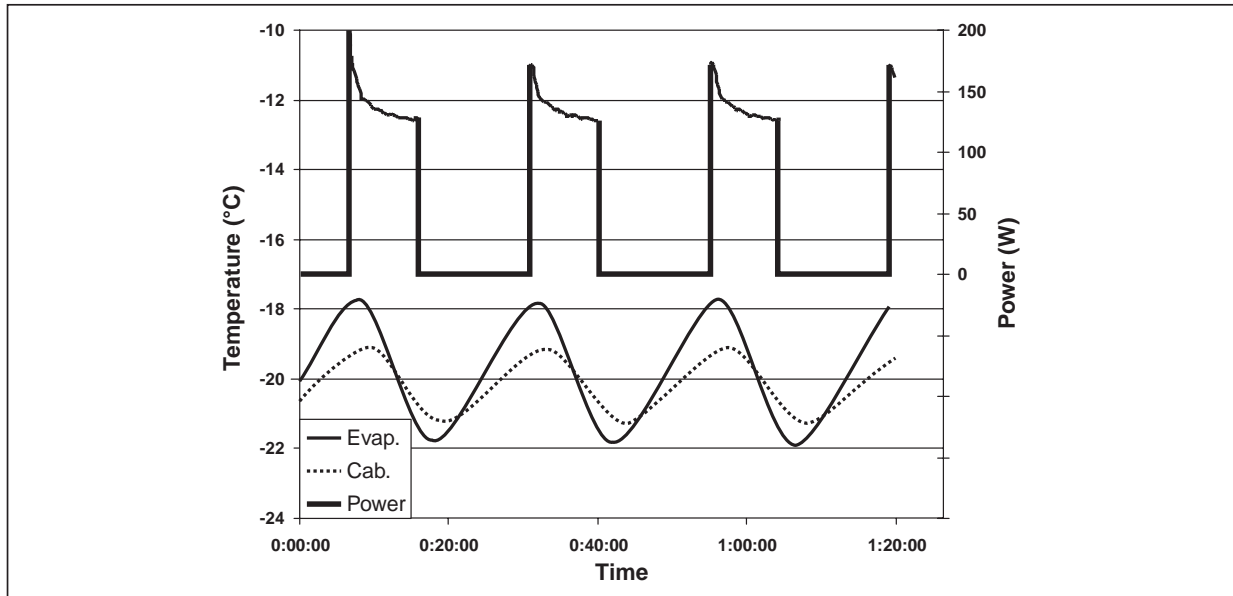

5. CONCLUSION

Reliable electronic thermostats can now be implemented instead of dated bi-metallic solutions. This allows large efficiency gains to be achieved, thanks to the removal of the PTC and to a smarter temperature management.

These improvements can also permit cold appliances designers to downsize the compressor and the evaporator.

Furthermore, switching to MCU based controls will allow higher flexibility and adaptability for designers and will help them to enhance the differentiation of their appliances. Thus, automatic routines (like defrost cycle) can be implemented and the end-customer interface can be improved (e.g temperature information, open door warning, temperature alarm, smooth light-up of the internal bulb by electronic dimming, etc.).

In terms of cost, electronics can now be competitive with electromechanics. A complete thermostat board, plus the sensor, can reach a cost similar to electromechanical. Furthermore, some features, as extended life time or spark-free operation, come for free with electronics.

Information furnished is believed to be accurate and reliable. However, STMicroelectronics assumes no responsibility for the consequences of use of such information nor for any infringement of patents or other rights of third parties which may result from its use. No license is granted by implication or otherwise under any patent or patent rights of STMicroelectronics. Specifications mentioned in this publication are subject to change without notice. This publication supersedes and replaces all information previously supplied.

STMicroelectronics products are not authorized for use as critical components in life support devices or systems without express written approval of STMicroelectronics.

The ST logo is a registered trademark of STMicroelectronics

© 2002 STMicroelectronics - Printed in Italy - All rights reserved.

STMicroelectronics GROUP OF COMPANIES

Australia - Brazil - Canada - China - Finland - France - Germany
Hong Kong - India - Israel - Italy - Japan - Malaysia - Malta - Morocco - Singapore
Spain - Sweden - Switzerland - United Kingdom - United States.

<http://www.st.com>



LittleDiode supplies new, hard to find or obsolete electronic components and semiconductors all over the world.

With over two million different components listed you are sure to find the part you need.

Feel free to visit us today at our online store:

LittleDiode.com

Looking forward to providing you with the best possible service.