

DATA SHEET

Part No.	AN12943A
Package Code No.	HSOP056-P-0300A

SEMICONDUCTOR COMPANY
MATSUSHITA ELECTRIC INDUSTRIAL CO., LTD.

Contents

■ Overview	3
■ Features	3
■ Applications	3
■ Block Diagram	4
■ Pin Descriptions	5
■ Absolute Maximum Ratings	7
■ Operating Supply Voltage Range	7
■ Electrical Characteristics	8
■ Control Terminal, The Mode Table	11
■ Technical Data	12
• Circuit diagrams of the input/output part and pin function descriptions	12
• Control sequence at power on/off	19
• Power dissipation of package HSOP056-P-0300A	20
• Usage notes	20
• Main characteristics	21

AN12943A

Audio signal processing IC for notebook PC

■ Overview

AN12943A is an one-chip IC for the stereo speakers which can output 1 W by 8 Ω , headphone amplifiers, line amplifiers and electronic volumes.

Since the headphone amplifier is a dual power supply system which uses a DC-DC converter to create the negative power source, an output capacitor is not necessary.

Also the AN12943A is built-in power saving on/off function automatically detecting input signal to save the power of speaker amplifier.

■ Features

- Speaker amplifier
1 W \times 2-channel: 8 Ω , $V_{CC} = 5$ V
- Headphone amplifier
Dual power supply system doesn't require output capacitor.
- Built-in automatic power saving function.
It detects input signals and switches on/off (with the on/off switch for the auto power saving).
- Built-in electronic volume and line amplifier

■ Applications

- Notebook PC

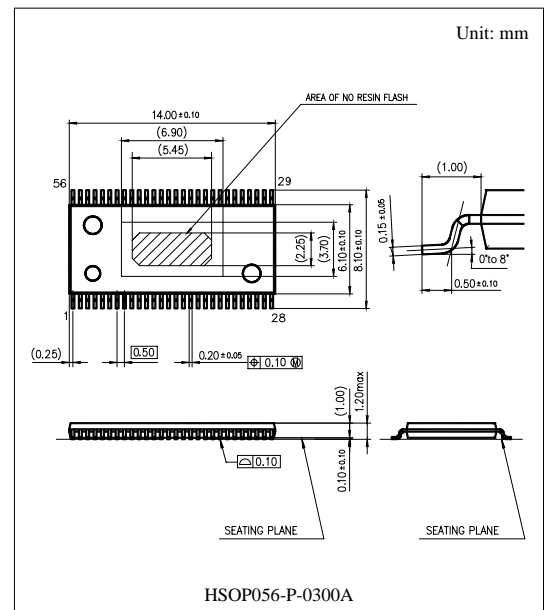

■ Block Diagram

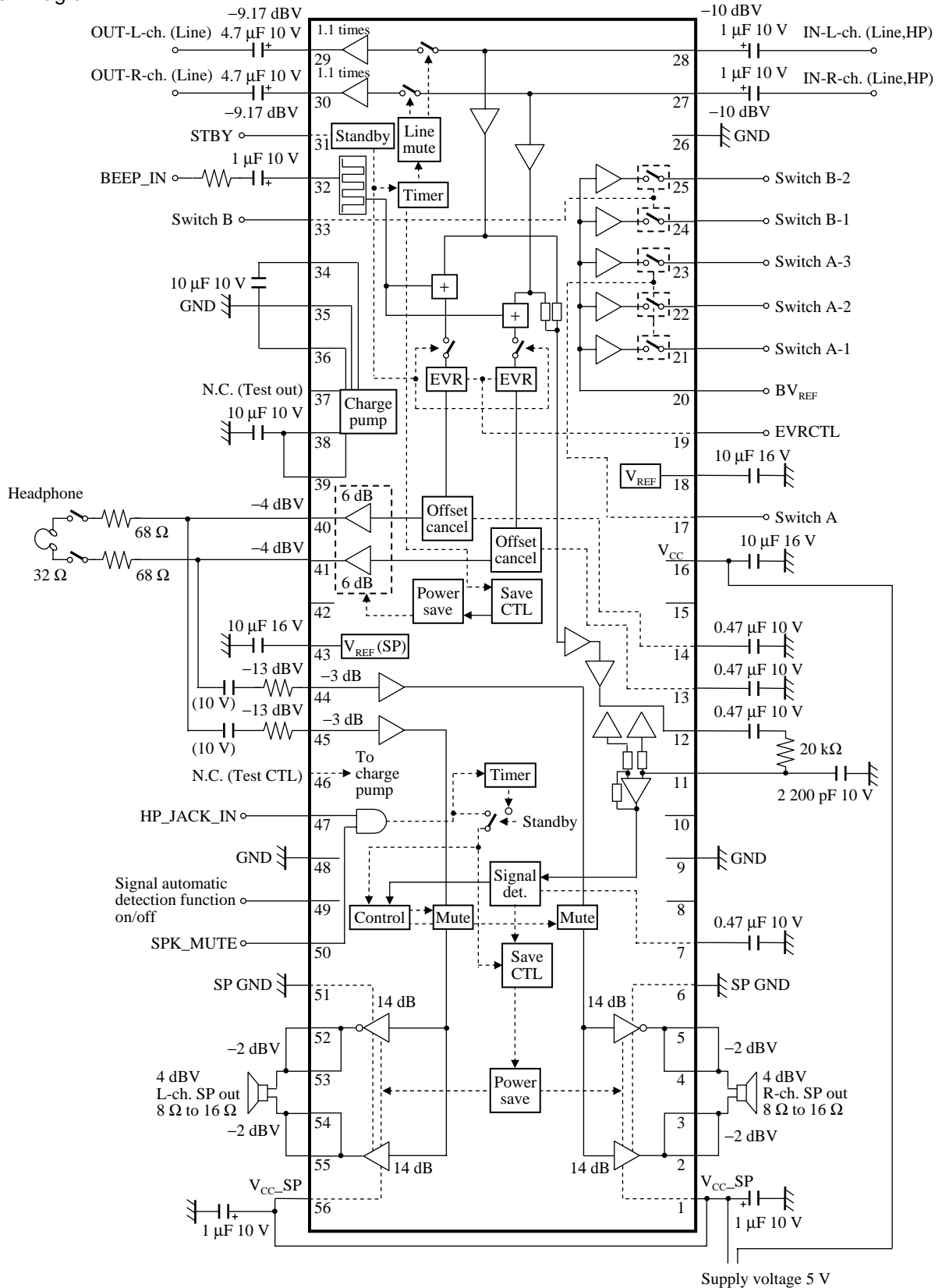

■ Pin Descriptions

Pin No.	Pin name	Type	Description
1	V _{CC_SP_R}	V _{CC}	V _{CC_SP} R-channel
2	SP_OUT_R+	Output	Speaker amplifier R-channel positive phase output (+)
3	SP_OUT_R+	Output	Speaker amplifier R-channel positive phase output (+)
4	SP_OUT_R-	Output	Speaker amplifier R-channel negative phase output (-)
5	SP_OUT_R-	Output	Speaker amplifier R-channel negative phase output (-)
6	GND_SP	GND	GND_SP R-channel
7	DETECT_CAP	Input	Demodulation pin for signal automatic detection
8	N.C.	N.C.	N.C.
9	GND	GND	GND
10	N.C.	N.C.	N.C.
11	DETECT_IN	Input	Signal input for signal automatic detection
12	DAMP_OUT	Output	Signal automatic detection mix amplifier output
13	OFFSET_HPR	Input	Offset cancel pin for headphone R-channel
14	OFFSET_HPL	Input	Offset cancel pin for headphone L-channel
15	N.C.	N.C.	N.C.
16	V _{CC}	V _{CC}	V _{CC}
17	Switch A	Input	Switch A
18	V _{REF_IN}	Input	V _{REF}
19	EVR_CTL	Input	EVR control for speaker and headphone
20	BV _{REF}	Input	Bias in
21	Switch A-1	Output	Switch A-1
22	Switch A-2	Output	Switch A-2
23	Switch A-3	Output	Switch A-3
24	Switch B-1	Output	Switch B-1
25	Switch B-2	Output	Switch B-2
26	GND	GND	GND
27	INPUT_R	Input	R-channel input
28	INPUT_L	Input	L-channel input
29	LINEOUT_L	Output	Line L-channel output
30	LINEOUT_R	Output	Line R-channel output
31	STANDBY	Input	Standby on/off control
32	BEEP_IN	Input	Input for beep signal
33	Switch B	Input	Switch B
34	C1	Output	Capacitor connect pin 1 for charge pump

■ Pin Descriptions (continued)

Pin No.	Pin name	Type	Description
35	GND	GND	GND
36	C2	Output	Capacitor connect pin 2 for charge pump
37	N.C.	N.C.	N.C. (Test pin 1)
38	V _{SS}	V _{SS}	V _{SS}
39	V _{SS}	V _{SS}	V _{SS}
40	HP_OUT_L	Output	Headphone amplifier L-channel output
41	HP_OUT_R	Output	Headphone amplifier R-channel output
42	N.C.	N.C.	N.C.
43	V _{REF_SP}	Input	V _{REF_SP}
44	SP_IN_R	Input	Speaker amplifier R-channel input
45	SP_IN_L	Input	Speaker amplifier L-channel input
46	N.C.	N.C.	N.C. (Test pin 1)
47	HP_JACK_IN	Input	HP_JACK_IN signal input
48	GND	GND	GND
49	DETECT_ON	Input	Signal automatic detection on/off control
50	SPK_MUTE	Input	Speaker power save control
51	GND_SP	GND	GND_SP L-channel
52	SP_OUT_L-	Output	Speaker amplifier L-channel negative phase output (-)
53	SP_OUT_L-	Output	Speaker amplifier L-channel negative phase output (-)
54	SP_OUT_L+	Output	Speaker amplifier L-channel positive phase output (+)
55	SP_OUT_L+	Output	Speaker amplifier L-channel positive phase output (+)
56	V _{CC_SP}	V _{CC}	V _{CC_SP} L-channel

■ Absolute Maximum Ratings

A No.	Parameter	Symbol	Rating	Unit	Note
1	Supply voltage	V_{CC}	5.75	V	*1
		V_{CC_SP}	5.75		
2	Supply current	I_{CC}	—	A	—
3	Power dissipation	P_D	517	mW	*2
4	Storage temperature	T_{stg}	−55 to +150	°C	*3
5	Operating ambient temperature	T_{opr}	−20 to +75	°C	*3
6	Operating ambient atmospheric pressure	P_{opr}	$1.013 \times 10^5 \pm 0.61 \times 10^5$	Pa	—
7	Operating constant gravity	G_{opr}	9 810	m/s ²	—
8	Operating shock	S_{opr}	4 900	m/s ²	—

Note) *1: The values under the condition not exceeding the above absolute maximum ratings and the power dissipation.

*2: When using this IC, referring to ■ Technical Data, • Power dissipation of package HSOP056-P-0300A.

Be sure to use the IC so that the power dissipation of the IC without heat sink will not exceed 517 mW at $T_a = 75^\circ\text{C}$.

*3: Except for the operating ambient temperature and storage temperature, all ratings are for $T_a = 25^\circ\text{C}$.

■ Operating Supply Voltage Range

Parameter	Symbol	Range	Unit	Note
Operating supply voltage range	V_{CC}	4.50 to 5.50	V	—
	V_{CC_SP}	4.50 to 5.50		*

Note) *: The values under the condition not exceeding the above absolute maximum ratings and the power dissipation.

■ Electrical Characteristics at $V_{CC} = 5.0\text{ V}$, $V_{CC_SP} = 5.0\text{ V}$

 Note) $T_a = 25^\circ\text{C} \pm 2^\circ\text{C}$ unless otherwise specified.

B No.	Parameter	Symbol	Test circuits	Conditions	Limits			Unit	Note
					min	typ	max		
Circuit current									
1	Circuit current 1A at non-signal (V_{CC_SP})	IT1A	1	$V_{CC} = 5.00\text{ V}$, at non-signal, at automatic distinction: on	—	50	100	μA	—
2	Circuit current 2A at non-signal (V_{CC})	IT2A	1		20.0	29.0	38.0	mA	—
3	Circuit current 1B at non-signal (V_{CC_SP})	IT1B	1	$V_{CC} = 5.00\text{ V}$, at non-signal, SP power save: off, at automatic distinction: off	—	15.0	25.0	mA	—
4	Circuit current 2B at non-signal (V_{CC})	IT2B	1		21.0	30.0	39.0	mA	—
5	Circuit current 1C at non-signal (V_{CC_SP})	IT1C	1	$V_{CC} = 5.00\text{ V}$, at non-signal, SP power save: on, at automatic distinction: off	—	55	100	μA	—
6	Circuit current 2C at non-signal (V_{CC})	IT2C	1		19.0	28.0	37.0	mA	—
7	Standby current 1 at non-signal (V_{CC_SP})	IST1	1	$V_{CC} = 5.00\text{ V}$, at standby mode	—	16	100	μA	—
8	Standby current 2 at non-signal (V_{CC})	IST2	1		—	17	100	μA	—
Speaker amplifier ($R_L = 8\ \Omega$): Speaker_input (pin 44, pin 45) → Speaker_output (pin 2 to pin 5, pin 52 to pin 55)									
9	Output level L-channel	VSPL	1	$V_{IN} = -13\text{ dBV}$, $f = 1\text{ kHz}$, $R_L = 8\ \Omega$	2.0	4.0	6.0	dBV	—
10	Output level R-channel	VSPR	1		2.0	4.0	6.0	dBV	—
11	Output distortion L-channel	TH _S L	1	$V_{IN} = -13\text{ dBV}$, $f = 1\text{ kHz}$, $R_L = 8\ \Omega$, to THD fifth	—	0.04	0.5	%	—
12	Output distortion R-channel	TH _S R	1		—	0.04	0.5	%	—
13	Maximum output electric power L-channel	VMAXSL	1	$V_{IN} = 1\text{ kHz}$, THD = 1%, $R_L = 8\ \Omega$	0.7	0.81	—	W	—
14	Maximum output electric power R-channel	VMAXSR	1		0.7	0.81	—	W	—
15	Output noise L-channel	VNSL	1	$R_g = 1\text{ k}\Omega$, $R_L = 8\ \Omega$, A curve filter	—	-89	-67	dBV	—
16	Output noise R-channel	VNSR	1		—	-89	-67	dBV	—
17	Channel balance	CHBS	1	$V_{IN} = -13\text{ dBV}$, $f = 1\text{ kHz}$, $R_L = 8\ \Omega$	-1	0	1	dB	—
18	Cross talk in L-channel	CTLSLR	1	$V_{IN} = -13\text{ dBV}$, $f = 1\text{ kHz}$, $R_L = 8\ \Omega$, A curve filter	70	90	—	dB	—
19	Cross talk in R-channel	CTLSRL	1		70	90	—	dB	—
Headphone amplifier ($R_L = 32\ \Omega$): L-channel, R-channel_input (pin 28, pin 27) → Headphone_output (pin 40, pin 41)									
20	Output level L-channel	VHPL	1	$V_{IN} = -10\text{ dBV}$, $R_L = 100\ \Omega$, $V_{ol} = 3.3\text{ V (max)}$, $f = 1\text{ kHz}$	-5.0	-4.0	-3.0	dBV	—
21	Output level R-channel	VHPR	1		-5.0	-4.0	-3.0	dBV	—
22	Channel balance	CHBH	1	$V_{IN} = -10\text{ dBV}$, $R_L = 100\ \Omega$, $V_{ol} = 3.3\text{ V (max)}$, $f = 1\text{ kHz}$, R-ch./L-ch. difference	-1.0	0.0	1.0	dB	—

■ Electrical Characteristics at $V_{CC} = 5.0\text{ V}$, $V_{CC-SP} = 5.0\text{ V}$ (continued)

 Note) $T_a = 25^\circ\text{C} \pm 2^\circ\text{C}$ unless otherwise specified.

B No.	Parameter	Symbol	Test circuits	Conditions	Limits			Unit	Note
					min	typ	max		
Headphone Amplifier ($R_L = 32\ \Omega$) (continued): L-channel, R-channel_input (pin 28, pin 27) → Headphone_output (pin 40, pin 41)									
23	Output distortion L-channel	THHL	1	$V_{OUT} = -14\text{ dBV}$, $R_L = 100\ \Omega$ $V_{ol} = 3.3\text{ V (max)}$, $f = 1\text{ kHz}$ to THD fifth	—	0.03	0.1	%	—
24	Output distortion R-channel	THHR	1		—	0.03	0.1	%	—
25	Maximum input level L-channel	VMAHIL	1	THD = 1%, $R_L = 100\ \Omega$ $V_{ol} = 1.65\text{ V (typ)}$, $f = 1\text{ kHz}$	0.0	4.7	—	dBV	—
26	Maximum input level R-channel	VMAHIR	1		0.0	4.7	—	dBV	—
27	Maximum output level L-channel	VMAHOL	1	THD = 1%, $R_L = 100\ \Omega$ $V_{ol} = 3.3\text{ V (max)}$, $f = 1\text{ kHz}$	0.0	3.4	—	dBV	—
28	Maximum output level R-channel	VMAHOR	1		0.0	3.4	—	dBV	—
29	Output noise L-channel	VNHL	1	$R_g = 1\text{ k}\Omega$, A curve filter	—	-94	-79	dBV	—
30	Output noise R-channel	VNHR	1		—	-94	-79	dBV	—
31	Cross talk in L-channel	CTLHLR	1	$V_{IN} = -10\text{ dBV}$, $R_L = 100\ \Omega$ $f = 10\text{ kHz}$, A curve filter	60	79	—	dB	—
32	Cross talk in R-channel	CTLHRL	1		60	79	—	dB	—
33	Beep output level L-channel	BEHL	1	$V_{IN} = 3.3\text{ V}_{PP}$, $R_L = 100\ \Omega$ 1 cycle = 1 ms	0.28	0.58	—	V_{PP}	—
34	Beep output level R-channel	BEHR	1		0.28	0.58	—	V_{PP}	—
Volume part: L-channel, R-channel_input (pin 28, pin 27) → Headphone_output (pin 40, pin 41)									
35	Medium voltage gain L-channel	VOLL	1	$V_{IN} = -20\text{ dBV}$, $f = 1\text{ kHz}$, $V_{ol} = 1.65\text{ V (typ)}$	-32.5	-30.0	-27.5	dBV	—
36	Medium voltage gain R-channel	VOLR	1		-32.5	-30.0	-27.5	dBV	—
37	Channel balance at the time of the medium gain	V_{CHB}	1	$V_{IN} = -20\text{ dBV}$, $f = 1\text{ kHz}$, $V_{ol} = 1.65\text{ V (typ)}$ R-ch./L-ch. difference	-2.0	0.0	2.0	dB	—
38	Volume maximum attenuation quantity L-channel	VOLNL	1	$V_{IN} = -10\text{ dBV}$, $f = 1\text{ kHz}$, $V_{ol} = 0.0\text{ V (min)}$, A curve filter	70	90	—	dB	—
39	Volume maximum attenuation quantity R-channel	VOLNR	1		70	90	—	dB	—
Line amplifier part: L-channel, R-channel_input (pin 28, pin 27) → Line_output (pin 29, pin 30)									
40	Output level L-channel	VHLL	1	$V_{IN} = -10\text{ dBV}$, $R_L = 10\text{ k}\Omega$, $f = 1\text{ kHz}$	-10.0	-9.2	-8.4	dBV	—
41	Output level R-channel	VHLR	1		-10.0	-9.2	-8.4	dBV	—
42	Channel balance	CHBL	1	$V_{IN} = -10\text{ dBV}$, $R_L = 10\text{ k}\Omega$, $f = 1\text{ kHz}$, R-ch./L-ch. difference	-0.8	0.0	0.8	dB	—
43	Output distortion L-channel	THLL	1	$V_{IN} = -10\text{ dBV}$, $R_L = 10\text{ k}\Omega$, $f = 1\text{ kHz}$, to THD fifth	—	0.003	0.03	%	—
44	Output distortion R-channel	THLR	1		—	0.003	0.03	%	—
45	Maximum output level L-channel	VMALL5	1	THD = 1%, $R_L = 10\text{ k}\Omega$ $f = 1\text{ kHz}$	0.0	4.1	—	dBV	—
46	Maximum output level R-channel	VMALR5	1		0.0	4.1	—	dBV	—
47	Output noise L-channel	VNLL	1	$R_g = 1\text{ k}\Omega$, A curve filter	—	-105	-87	dBV	—
48	Output noise R-channel	VNLR	1		—	-105	-87	dBV	—

Electrical Characteristics at $V_{CC} = 5.0\text{ V}$, $V_{CC-SP} = 5.0\text{ V}$ (continued)

 Note) $T_a = 25^\circ\text{C} \pm 2^\circ\text{C}$ unless otherwise specified.

B No.	Parameter	Symbol	Test circuits	Conditions	Limits			Unit	Note
					min	typ	max		
Line amplifier part (continued): L-channel, R-channel_input (pin 28, pin 27) → Line_output (pin 29, pin 30)									
49	Cross talk in L-channel	CTLLLR	1	$V_{IN} = -10\text{ dBV}$, $R_L = 10\text{ k}\Omega$ $f = 10\text{ kHz}$, A curve filter	60	88	—	dB	—
50	Cross talk in R-channel	CTLLRL	1		60	88	—	dB	—
Automatic signal detection part: L-channel, R-channel_input (pin 28, pin 27) → Signal detection preamplifier output (pin 12)									
51	Preamplifier output voltage level L-channel entry	VSDTL	1	$V_{IN} = -49\text{ dBV}$, $f = 1\text{ kHz}$ $V_{ol} = 1.65\text{ V}$ (typ)	-13	-10	-7	dBV	—
52	Preamplifier output voltage level R-channel entry	VSDTR	1		-13	-10	-7	dBV	—
53	Signal detection limit entry voltage level L-channel	VSDTTHL	1	$V_{IN} = 1\text{ kHz}$ $V_{ol} = 1.65\text{ V}$ (typ)	-70	-65	-60	dBV	—
54	Signal detection limit entry voltage level R-channel	VSDTTHR	1		-70	-65	-60	dBV	—
Other part									
55	SP output DC offset voltage L-channel	VDCSPL	1	DC voltage between positive and opposite at non-signal	-112	0	112	mV	—
56	SP output DC offset voltage R-channel	VDCSPR	1		-112	0	112	mV	—
57	Output at SP power save L-channel	VPSPPSL	1	$V_{IN} = -13\text{ dBV}$, $f = 1\text{ kHz}$, $R_L = 8\ \Omega$, A curve filter	—	-114	-70	dBV	—
58	Output at SP power save R-channel	VPSPPSR	1		—	-114	-70	dBV	—
59	Signal detection part Preamplifier output noise	VSDTLO	1	At non-signal, A curve filter	—	-62	-44	dBV	—
Switch switching-over voltage level									
60	Standby on	STON	—		GND	—	0.8	V	—
61	Standby off	STOF	—		2.0	—	3.6	V	—
62	SPK mute on	SPMON	—		GND	—	0.8	V	—
63	SPK mute off	SPMOF	—		2.0	—	5.5	V	—
64	Headphone jack on	HPJON	—		GND	—	0.8	V	—
65	Headphone jack off	HPJOF	—		2.0	—	5.5	V	—
66	Signal automatic detection feature on	ATON	—		GND	—	0.8	V	—
67	Signal automatic detection feature off	ATOF	—		2.0	—	5.5	V	—
68	Switch A off	CMUOF	—		GND	—	0.8	V	—
69	Switch A on	CMUON	—		2.0	—	5.5	V	—
70	Switch B off	DMUOF	—		GND	—	0.8	V	—
71	Switch B on	DMUON	—		2.0	—	5.5	V	—

■ Control Terminal, The Mode Table

Note) The holding range of control voltage is shown in B No. 60 to B No. 71 of ■ Electrical Characteristics.





Pin No.	Description	Voltage		Remarks
		Low	High	
17	Switch A on/off	Off	On	—
31	Standby on/off	STB on (LINE MUTE on) (HP SAVE on) (HP MUTE on)	STB off (LINE MUTE off) (HP SAVE off) (HP MUTE off)	—
33	Switch B on/off	Off	On	—
49	The signal automatic detection feature on/off	Automatic distinction: off	Automatic distinction: on	—

Pin No.	Description	Voltage		Remarks
		Both pin 47 and pin 50 = High	Either pin 47 or pin 50 = Low	
47 50	HP JACK SPK MUTE	SPK power save off (SP on)	SPK power save on (SP off)	It has priority over power saving by pin 47 and pin 50 more than an automatic detection.

■ Technical Data

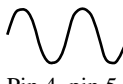
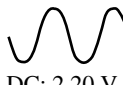
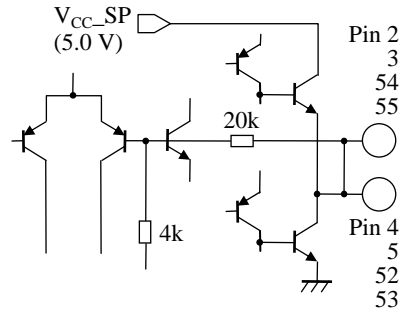
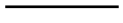
• Circuit diagrams of the input/output part and pin function descriptions

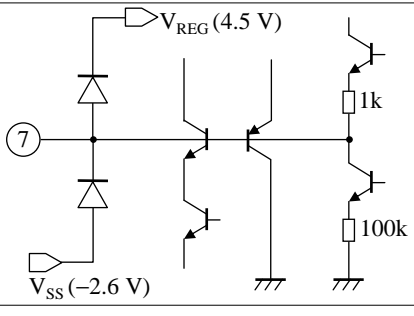







Note) The characteristics listed below are reference values based on the IC design and are not guaranteed.

Pin No.	Waveform and voltage	Inner circuit	Impedance	Description
1, 56	V_{CC_SP}  DC: 5.0 V	—	—	Power supply pins specifically designed for speaker amplifiers. <ul style="list-style-type: none"> • Pin 1 for R-channel. • Pin 56 for L-channel. Because the big electric current flows, it is desirable to separate from the V_{CC} line to the other power supply pins on the board pattern.
2, 3, 4, 5, 52, 53, 54, 55	Speaker output Pin 2, pin 3 Pin 54, pin 55 Positive phase  Pin 4, pin 5 Pin 52, pin 53 Negative phase  DC: 2.20 V AC: 4 dBV		The output impedance: Equal to or less than 1 Ω	Output pins of speaker amplifiers. It becomes BTL output. <ul style="list-style-type: none"> • Pin 2, pin 3 for R-channel positive phase output • Pin 4, pin 5 for R-channel negative phase output • Pin 54, pin 55 for L-channel positive phase output • Pin 52, pin 53 for L-channel negative phase output To reduce voltage loss caused by the wire resistance in maximum output, it makes output 2 terminals. When the speaker amplifiers save power, DC voltage is also kept.
6, 51	GND_SP  DC: 0.0 V	—	—	It is GND pin for the speaker amplifier. <ul style="list-style-type: none"> • Pin 6 is for R-channel. • Pin 51 is for L-channel. Because the big electric current flows, it is desirable to separate from the GND line to the other GND pin on the board pattern. Also, it isn't connected with the substrate potential in the IC.
7	Audio automatic detection detection pin:  Signal nothing DC: 0.0 V Signal's there being DC: 2.0 V		Signal less time: Constant current source Signal's there being: The output impedance: About 1 k Ω	It connects a condenser for the peak detection. It is the circuit which detects a peak after rectifying the audio signal of the audio signal automatic detection circuit in both waves. By changing a capacity value, the time which the power saving depends on in case of the switchover which is without signal with signal's there being can be changed.
8, 10, 37, 46	NC 	—	—	—

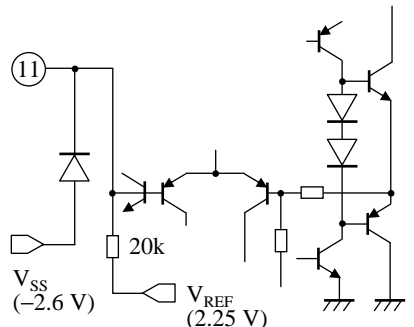
■ Technical Data (continued)

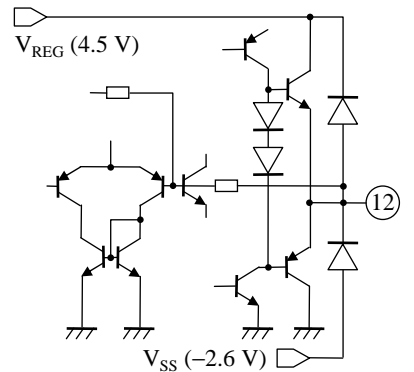
• Circuit diagrams of the input/output part and pin function descriptions (continued)

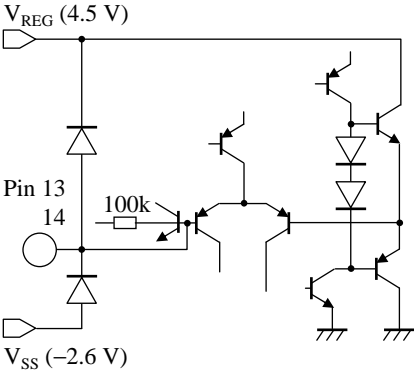



Note) The characteristics listed below are reference values based on the IC design and are not guaranteed.

Pin No.	Waveform and voltage	Inner circuit	Impedance	Description
9, 26, 48	GND  DC: 0.0 V	—	—	It is the GND pins of the signal system. It isn't connected with the substrate potential in the IC.
11	Signal input for signal automatic detection  DC: 2.25 V AC: -10 dBV		The entry impedance: About 20 k Ω	It is the signal input pin for signal automatic detection. It is possible to adjust in the direction lowers a gain by adding external resistance.
12	The signal detection system preamplifier output pin  DC: 2.25 V AC: -10 dBV		The output impedance: About 10 Ω	It is the output pin of the signal detection system preamplifier.
13, 14	Offset cancellation C pin  DC: 2.25 V		The entry impedance: About 100 k Ω	It is the condenser connection pin of the offset cancellation circuit to remove the DC offset. As the principle, it composes high pass filter by entry impedance "R" and connection condenser "C".
15, 42	NC 	—	—	Pin 15, pin 42 connect with the lead frame of the IC. Also, it is connected with the substrate potential in the IC. Please don't connect with the GND line on the board pattern.

■ Technical Data (continued)

• Circuit diagrams of the input/output part and pin function descriptions (continued)



Note) The characteristics listed below are reference values based on the IC design and are not guaranteed.

Pin No.	Waveform and voltage	Inner circuit	Impedance	Description
16	V_{CC}  DC: 5.0 V	—	—	It is the power supply (V_{CC}) pin to supply the regulator circuit to create the inner power supply V_{REG} with the voltage. It is separating from V_{CC-SP} of pin 1, pin 56 fully inside. It is desirable to separate as far as it finishes coming out about the P board pattern, too.
17, 33	Switch A/B on/off  DC: 0 V (at Open)		The entry impedance: About 100 k Ω	It change the switch A, B on/off. • High: On • Low: Off
18	V_{REF}  DC: 2.25 V		The entry impedance: About 250 k Ω	With the pin to fix the bias voltage (the operation point) of the system which the inner power supply (V_{REG}) works, it becomes 1/2 V_{REG} (V). To remove noise, it connects a condenser with the interval of GND.
19	EVR control for SP and HP  DC: — V		The entry impedance: The high impedance	It is the pin which controls EVR for speaker amplifier and Headphone amplifier. The holding range with control voltage is 0 V to 3.3 V.
20	BV_{REF}  DC: — V		The entry impedance: The high impedance	It is the input pin of DC voltage for switch A-1, A-2, A-3, B-1, B-2 output.

■ Technical Data (continued)

• Circuit diagrams of the input/output part and pin function descriptions (continued)

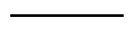
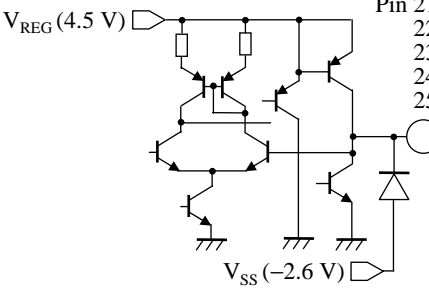

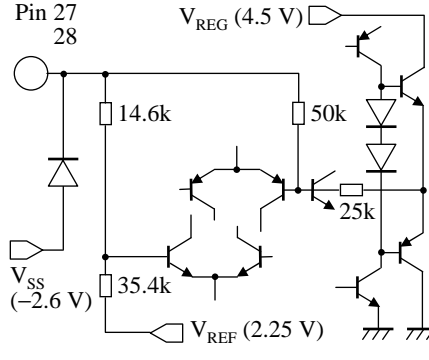
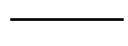
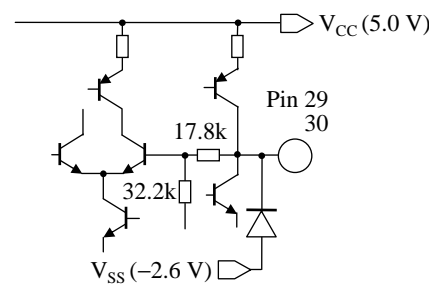
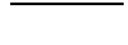
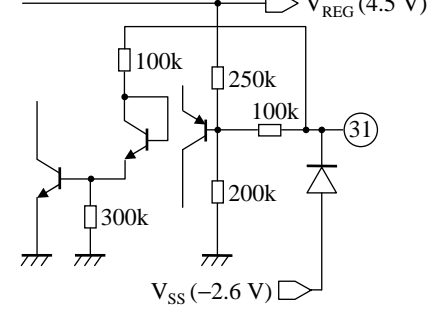

Note) The characteristics listed below are reference values based on the IC design and are not guaranteed.

Pin No.	Waveform and voltage	Inner circuit	Impedance	Description
21, 22, 23, 24, 25	Switch A-1 Switch A-2 Switch A-3 Switch B-1 Switch B-2  DC: — V		The output impedance: Equal to or less than about 10 Ω	It is the output pin of DC voltage. It outputs pin 20 (BV _{REF}) input voltage.
27, 28	Audio signal input  DC: 2.25 V AC: -10 dBV		The entry impedance: About 25 kΩ	It enters a main audio signal. <ul style="list-style-type: none"> • Pin 27: R-channel entry • Pin 28: L-channel entry
29, 30	Line out  AC: -9.17 dBV DC: 2.25 V		The output impedance: Equal to or less than about 10 Ω	It is the output pin of the line amplifier. <ul style="list-style-type: none"> • Pin 29: L-channel output • Pin 30: R-channel output
31	Standby on/off changing SW  DC: 2.0 V		The range under about 1.5 V. The entry impedance: About 210 kΩ The range over about 1.5 V. The entry impedance: About 68 kΩ	It changes whether or not it makes this IC an operation condition or whether or not it makes it a standby. <ul style="list-style-type: none"> • Low: Standby • High: The operation condition In that the power changes a connected condition to the standby, the circuit electric current can be almost made 0.

■ Technical Data (continued)

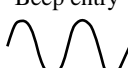
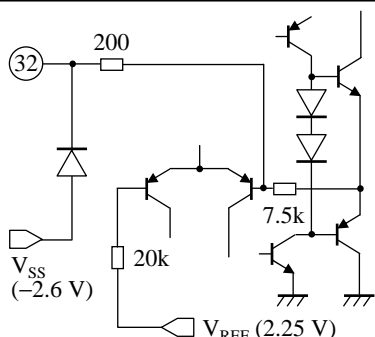
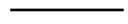
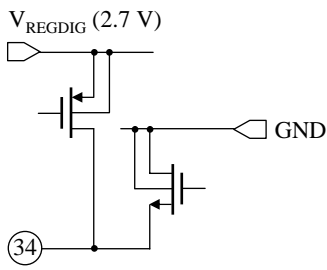
• Circuit diagrams of the input/output part and pin function descriptions (continued)

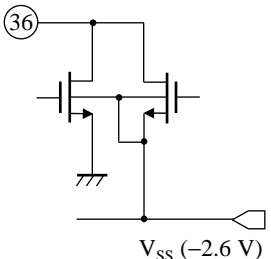



Note) The characteristics listed below are reference values based on the IC design and are not guaranteed.

Pin No.	Waveform and voltage	Inner circuit	Impedance	Description
32	<p>Beep entry</p>  <p>DC: 2.25 V AC: 3.3 V_{PP}</p>		The entry impedance: About 200 Ω	It is the entry pin to enter beep signal. The same signal is entered both by L-channel and R-channel with the beep signal mix amplifier of the following paragraph.
34	<p>Capacitor connect pin 1 for charge pump</p>  <p>DC: — V</p>		The output impedance: Equal to or less than about 10 Ω	It is the condenser connection pin for charge pump.
35	<p>GND</p>  <p>DC: 0.0 V</p>	—	—	It is GND pin for charge pump. It isn't connected with other GND pin in the IC.
36	<p>Capacitor connect pin 2 for charge pump</p>  <p>DC: — V</p>		The output impedance: Equal to or less than about 10 Ω	It is the condenser connection pin for charge pump.
38, 39	<p>V_{SS}</p>  <p>DC: -2.6 V</p>	—	—	It is the inner power (V _{SS}) pin to supply the HP amplifier with the voltage. Also, it is connected with the substrate potential in the IC.

■ Technical Data (continued)

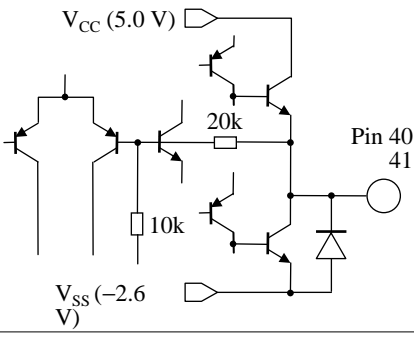
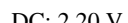
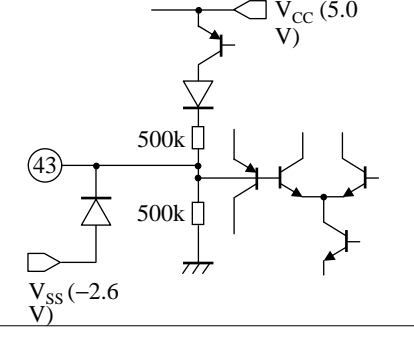
- Circuit diagrams of the input/output part and pin function descriptions (continued)

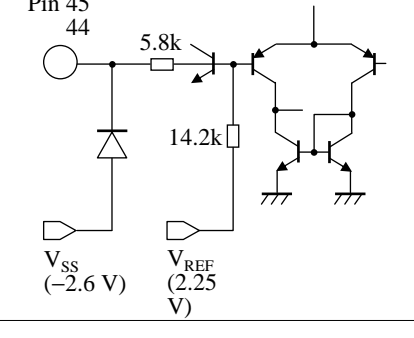

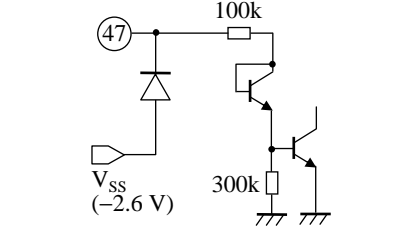
Note) The characteristics listed below are reference values based on the IC design and are not guaranteed.

Pin No.	Waveform and voltage	Inner circuit	Impedance	Description
40, 41	Output terminal for the HP amplifier  DC: 0 V AC: -4 dBV		The output impedance: Equal to or less than about 1 Ω	It is an output pin for the headphone amplifier. The signal which was adjusted in the volume in EVR can be output by the low impedance.
43	V _{REF} (SP)  DC: 2.20 V		The entry impedance: About 250 kΩ	It is the standard voltage pin to fix the DC bias of the speaker output. It connects a condenser to remove a ripple.
44, 45	Speaker amplifier entry  DC: 2.25 V AC: -13 dBV		The entry impedance: About 20 kΩ	It is the voice input pins of the speaker amplifier. To make offset voltage in power saving on/off changing by the speaker amplifier little, it combines capacity. (It makes POP noise small). • Pin 44: R-channel speaker entry • Pin 45: L-channel speaker entry
47	HP_JACK_IN signal input pin  DC: —		The range under about 1.5 V. The entry impedance: The high impedance The range over about 1.5 V. The entry impedance: About 100 kΩ	It is the pin which controls power saving by the speaker amplifier. At the time of on in addition to the control in case of automatic distinction function off, too, power saving on by pin 47, pin 50 has priority over.

■ Technical Data (continued)

- Circuit diagrams of the input/output part and pin function descriptions (continued)

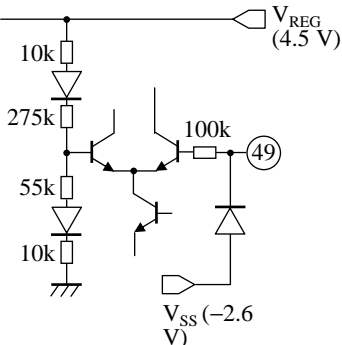
Note) The characteristics listed below are reference values based on the IC design and are not guaranteed.

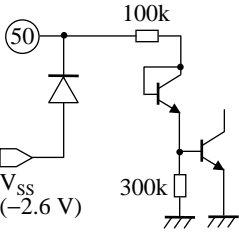
Pin No.	Waveform and voltage	Inner circuit	Impedance	Description
49	<p>Signal automatic detection function on/off control pin</p>  <p>DC: —</p>		<p>The entry impedance: The high impedance</p>	<p>We change an audio signal automatic detection function in on/off. In case of automatic detection off, it controls power saving by speaker with the manual with the power saving on/off pin.</p> <ul style="list-style-type: none"> • High: Function on • Low: Function off
50	<p>SP amplifier power saving on/off control pin</p>  <p>DC: —</p>		<p>The range under about 1.5 V. The entry impedance: The high impedance The range over about 1.5 V. The entry impedance: About 100 kΩ</p>	<p>It is the pin which controls power saving by the speaker amplifier. At the time of on in addition to the control in case of automatic distinction function off, too, power saving on by pin 47, pin 50 has priority over.</p>

■ Technical Data (continued)

- Control sequence at power on/off

At power on/off, as for the timing of each control pin, it much more recommends a procedure below the purpose of the pop noise measure in changing.

Moreover, this IC builds in a charge pump circuit and constitutes the substrate potential in IC. In order for substrate potential to be in a high impedance state and to prevent unusual operation before starting of a power supply, please do not impress voltage to each mode control pin.

Control timing

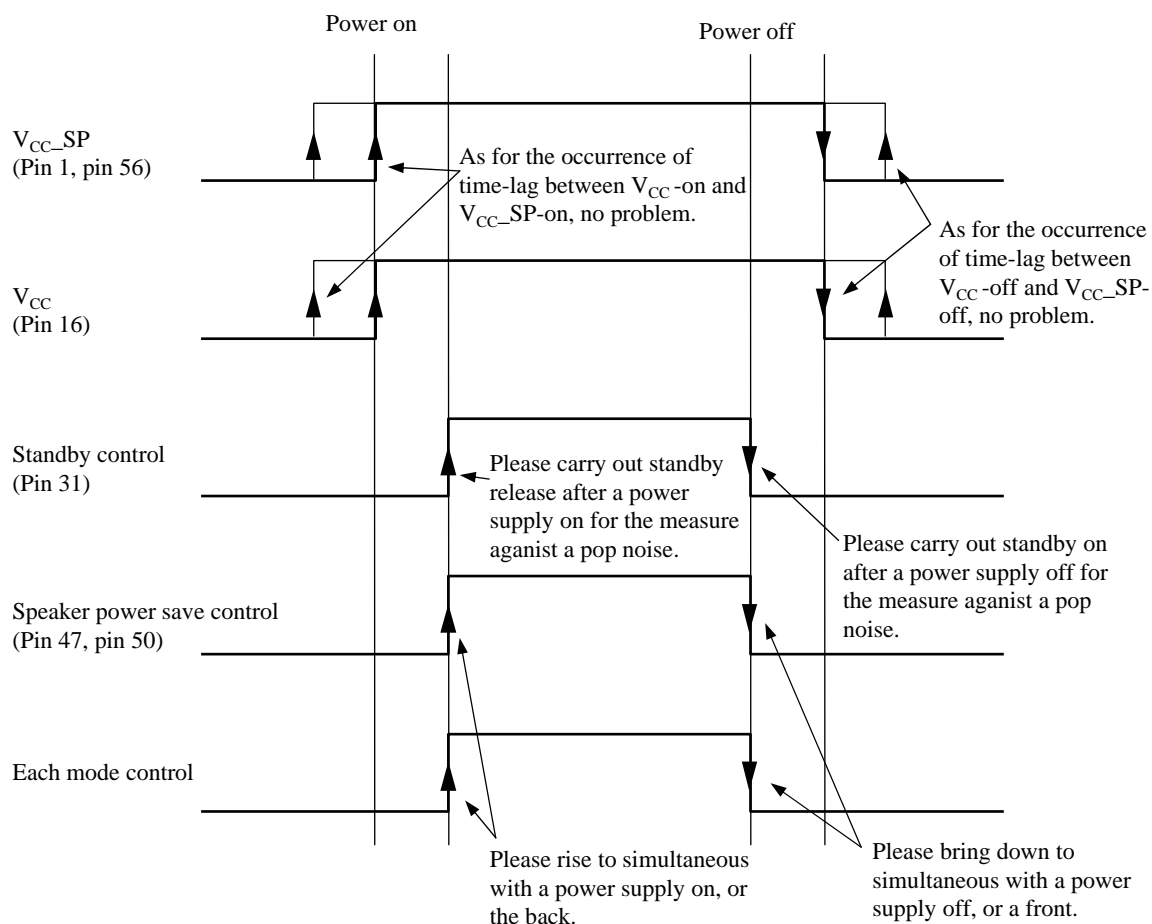

Note) The characteristics listed above are reference values based on the IC design and are not guaranteed.

■ Technical Data (continued)

- Power dissipation of package HSOP056-P-0300A

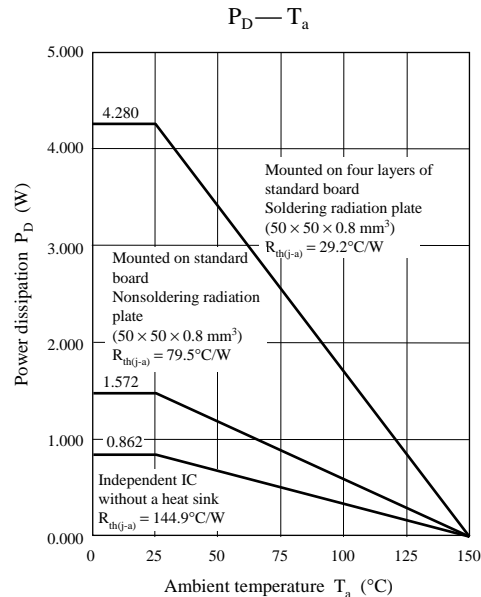

Note) The characteristics listed above are reference values based on the IC design and are not guaranteed.

• Usage notes

1. Please carry out the thermal design with sufficient margin such that the power dissipation will not be exceeded, based on the conditions of power supply, load and surrounding temperature.
Although indicated also in the column of the maximum rating, the maximum rating becomes an instant and the marginal value which must not exceed. It sufficiently evaluates, and I use-wish-do so that it may not exceed certainly.
Moreover, don't impress neither voltage nor current to pin which is not indicated. It may destroy in both cases.
2. Please pay attention in the pattern layout in order to prevent damage due to short circuit between pins.
In addition, for the pin configuration, please refer to ■ Pin Descriptions.
3. Please absolutely do not mount the LSI in the reverse direction on to the printed-circuit-board.
It might be damaged when the electricity is turned on.
4. Please do a visual inspection on the printed-circuit-board before turning on the power supply, otherwise damage might happen due to problems such as a solder-bridge between the pins of the semiconductor device.
Also perform a full technical verification on the assembly quality, because the same damage possibly can happen due to conductive substances, such as solder ball, that adhere to the LSI during transportation.
5. Please take notice in the use of this product that it might break or occasionally smoke when an abnormal state occurs such as output pin, pin 34 and pin 36 (capacitor connect pin 1, 2 for charge pump), pin 38 and pin 39 (V_{SS}) – power supply pin short, output pin, pin 34 and pin 36, pin 38 and pin 39 – GND short, or output-to-output-pin short (load short), pin 34 – pin 36 short.
And, safety measures such as an installation of fuses are recommended because the extent of the above-mentioned damage and smoke emission will depend on the current capability of the power supply.
6. When using the LSI for model deployment or new products, perform fully the safety verification including the long-term reliability for each product.

■ Technical Data (continued)

• Main characteristics

1) Speaker amplifier

$V_{CC} = 5.0\text{ V}$, $V_{CC-SP} = 5.0\text{ V}$, $f_{req} = 1\text{ kHz}$, $EVR = 3.3\text{ V}$, LINE input (pin 27), 24 k Ω -ATT, Automatic detection on, HPF: 400 Hz, LPF: 30 kHz

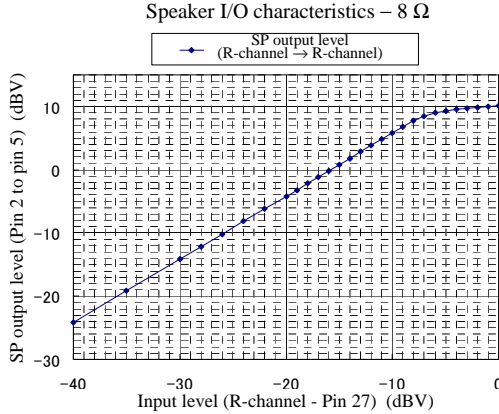

$V_{CC} = 5.0\text{ V}$, $V_{CC-SP} = 5.0\text{ V}$, $f_{req} = 1\text{ kHz}$, $EVR = 3.3\text{ V}$, LINE input (pin 27), 24 k Ω -ATT, Automatic detection on, HPF: 400 Hz, LPF: 30 kHz

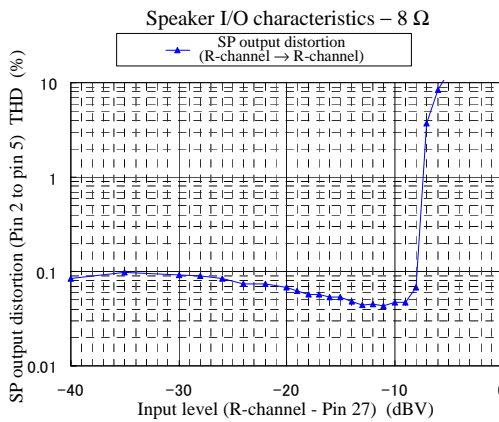

$V_{CC} = 5.0\text{ V}$, $V_{CC-SP} = 5.0\text{ V}$, $V_{IN} = -10\text{ dBV}$, $EVR = 3.3\text{ V}$, LINE input (pin 27), 24 k Ω -ATT, Automatic detection on

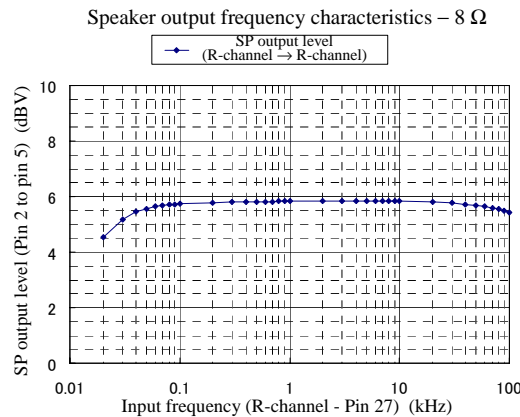

$V_{CC} = 5.0\text{ V}$, $V_{CC-SP} = 5.0\text{ V}$, $f_{req} = 1\text{ kHz}$, $EVR = 3.3\text{ V}$, LINE input (pin 28), 24 k Ω -ATT, Automatic detection on, HPF: 400 Hz, LPF: 30 kHz

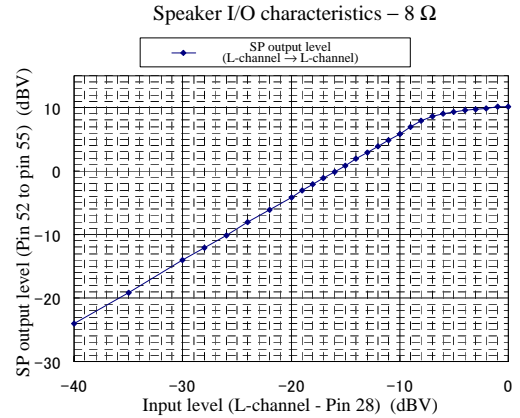

$V_{CC} = 5.0\text{ V}$, $V_{CC-SP} = 5.0\text{ V}$, $f_{req} = 1\text{ kHz}$, $EVR = 3.3\text{ V}$, LINE input (pin 28), 24 k Ω -ATT, Automatic detection on, HPF: 400 Hz, LPF: 30 kHz

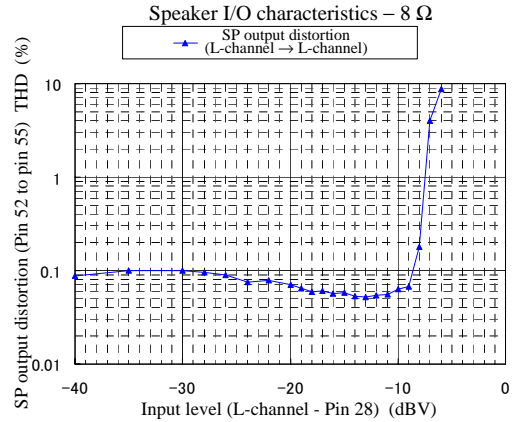

$V_{CC} = 5.0\text{ V}$, $V_{CC-SP} = 5.0\text{ V}$, $V_{IN} = -10\text{ dBV}$, $EVR = 3.3\text{ V}$, LINE input (pin 28), 24 k Ω -ATT, Automatic detection on

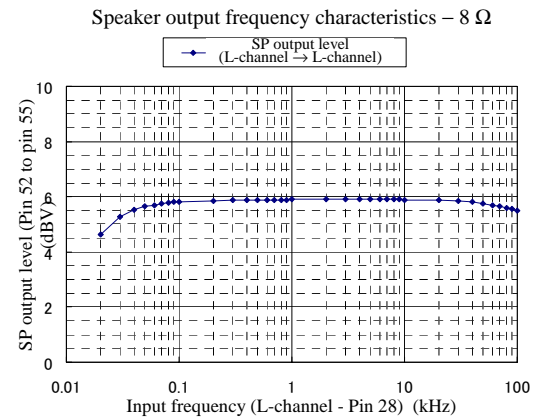

■ Technical Data (continued)

• Main characteristics (continued)

1) Speaker amplifier (continued)

$V_{CC} = 5.0\text{ V}$, $V_{CC-SP} = 5.0\text{ V}$, $V_{IN} = -10\text{ dBV}$, $EVR = 3.3\text{ V}$, LINE input (pin 27), 24 k Ω -ATT, Automatic detection on, LPF: 30 kHz (20 kHz to 1 kHz), LPF: 80 kHz (2 kHz to 10 kHz)

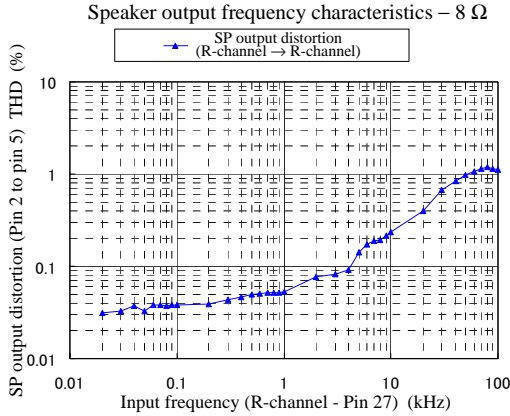

$V_{CC} = 5.0\text{ V}$, $V_{CC-SP} = 5.0\text{ V}$, $V_{IN} = -10\text{ dBV}$, $EVR = 3.3\text{ V}$, LINE input (pin 28), 24 k Ω -ATT, Automatic detection on, LPF: 30 kHz (20 kHz to 1 kHz), LPF: 80 kHz (2 kHz to 10 kHz)

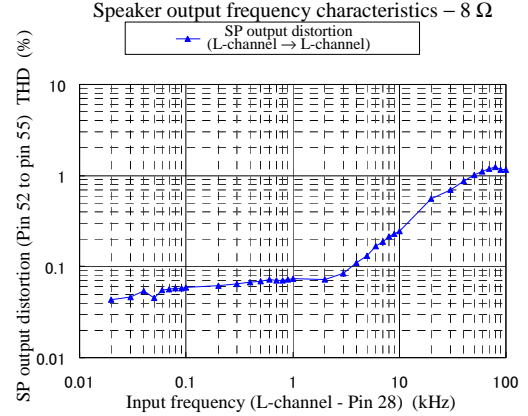

$V_{CC} = 5.0\text{ V}$, $V_{CC-SP} = 5.0\text{ V}$, $V_{IN} = -10\text{ dBV}$, $EVR = 3.3\text{ V}$, LINE input (pin 28), 24 k Ω -ATT, Automatic detection on, 30 kHz: LPF

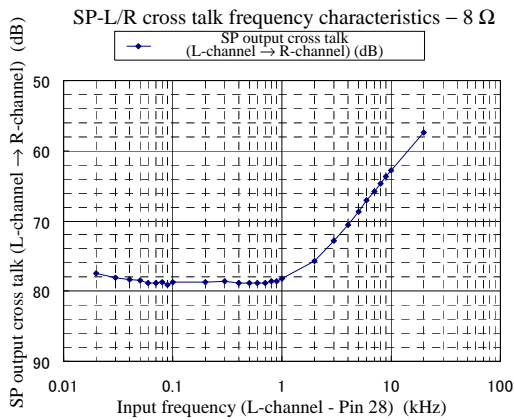

$V_{CC} = 5.0\text{ V}$, $V_{CC-SP} = 5.0\text{ V}$, $V_{IN} = -10\text{ dBV}$, $EVR = 3.3\text{ V}$, LINE input (pin 27), 24 k Ω -ATT, Automatic detection on, 30 kHz: LPF

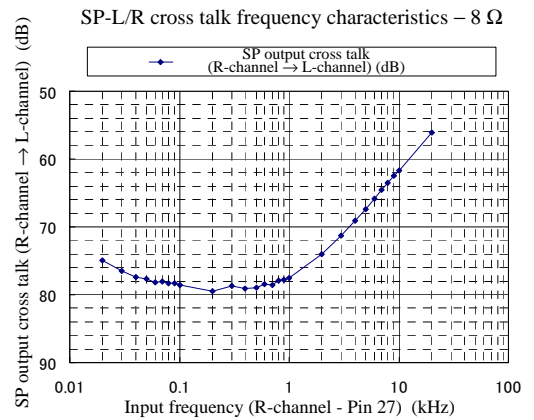

■ Technical Data (continued)

• Main characteristics (continued)

2) Headphone amplifier

$V_{CC} = 5.0\text{ V}$, $V_{CC-SP} = 5.0\text{ V}$, $f_{req} = 1\text{ kHz}$, $R_{out} = 100\ \Omega$, $EVR = 3.3\text{ V}$, Automatic detection on, HPF: 400 Hz, LPF: 30 kHz

Headphone amplifier I/O characteristics - EVR = max (Single-channel input)

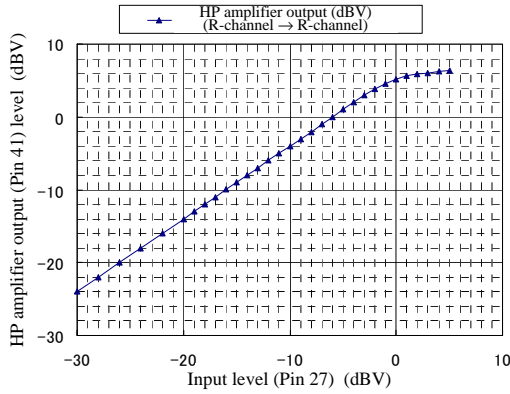

Headphone amplifier I/O characteristics - EVR = max (Single-channel input)

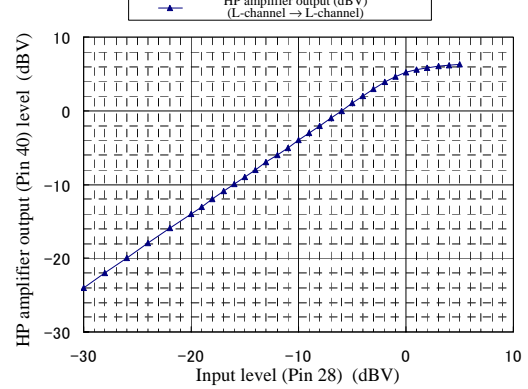

$V_{CC} = 5.0\text{ V}$, $V_{CC-SP} = 5.0\text{ V}$, $f_{req} = 1\text{ kHz}$, $R_{out} = 100\ \Omega$, $EVR = 3.3\text{ V}$, Automatic detection on, HPF: 400 Hz, LPF: 30 kHz

Headphone amplifier I/O distortion characteristics - EVR = max (Single-channel input)

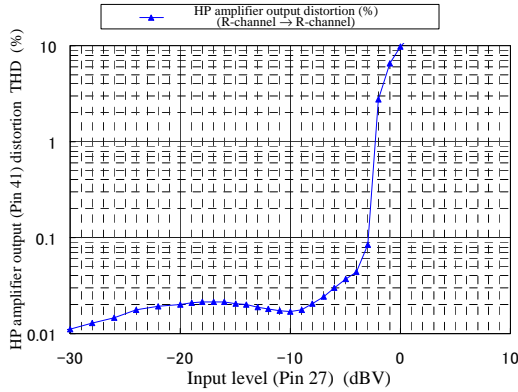

Headphone amplifier I/O distortion characteristics - EVR = max (Single-channel input)

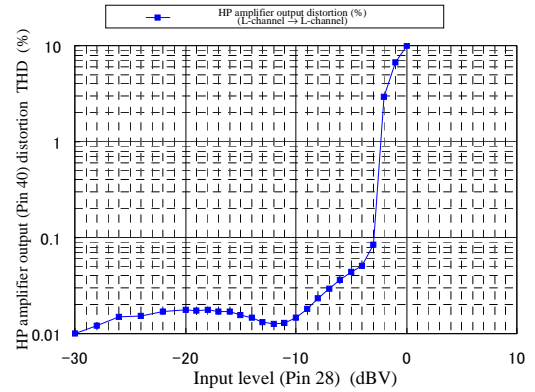

$V_{CC} = 5.0\text{ V}$, $V_{CC-SP} = 5.0\text{ V}$, $V_{IN} = -10\text{ dBV}$, $R_{out} = 100\ \Omega$, $EVR = 3.3\text{ V}$, Automatic detection on

Headphone amplifier frequency characteristics - EVR = max (Single-channel input)

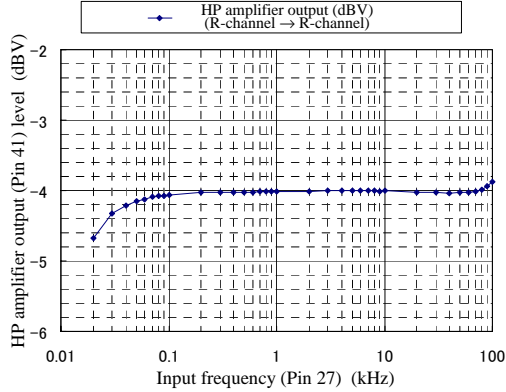

Headphone amplifier frequency characteristics - EVR = max (Single-channel input)

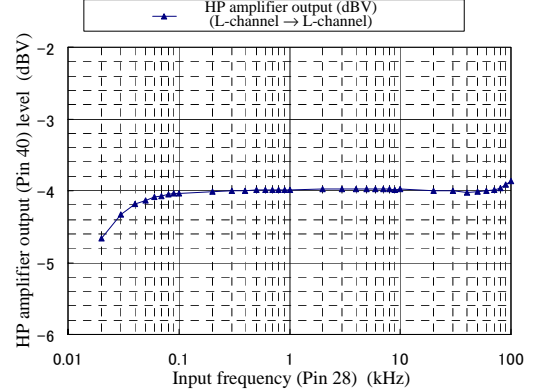

■ Technical Data (continued)

- Main characteristics (continued)

2) Headphone amplifier (continued)

$V_{CC} = 5.0\text{ V}$, $V_{CC-SP} = 5.0\text{ V}$, $V_{IN} = -10\text{ dBV}$, $R_{out} = 100\ \Omega$, $EVR = 3.3\text{ V}$, Automatic detection on, LPF: 30 kHz (20 kHz to 1 kHz), LPF: 80 kHz (2 kHz to 10 kHz)

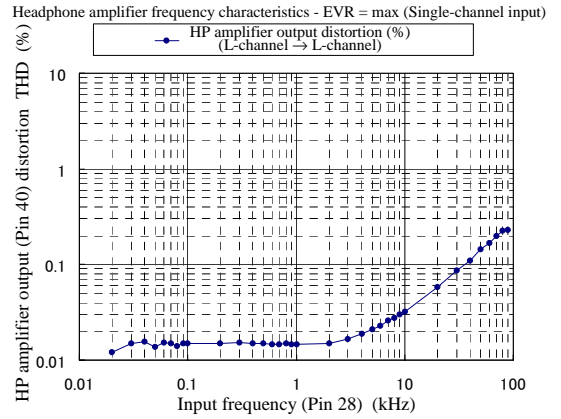
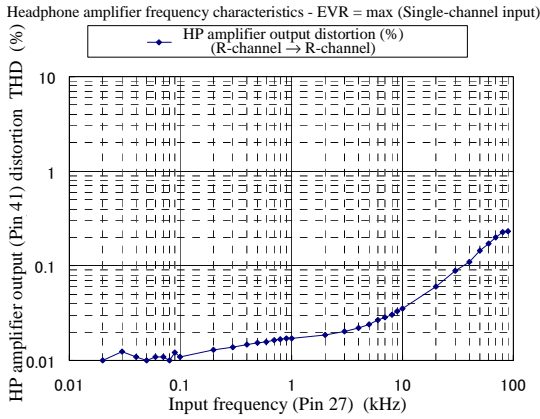

$V_{CC} = 5.0\text{ V}$, $V_{CC-SP} = 5.0\text{ V}$, $V_{IN} = -10\text{ dBV}$, $EVR = 3.3\text{ V}$, $R_{out} = 100\ \Omega$, Automatic detection on, 30 kHz: LPF

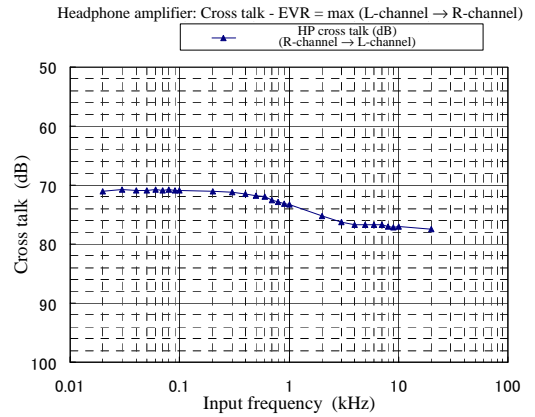
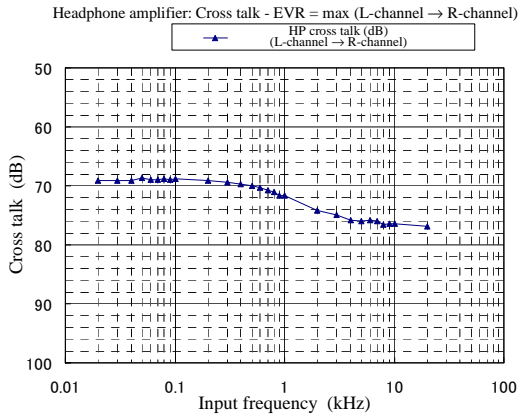

■ Technical Data (continued)

- Main characteristics (continued)

3) Line amplifier

$V_{CC} = 5.0\text{ V}$, $V_{CC-SP} = 5.0\text{ V}$, $f_{req} = 1\text{ kHz}$, $R_L = 10\text{ k}\Omega$, $R_L(HP) = 100\ \Omega$, $EVR = 3.3\text{ V}$, Automatic detection on, HPF: 400 Hz, LPF: 30 kHz

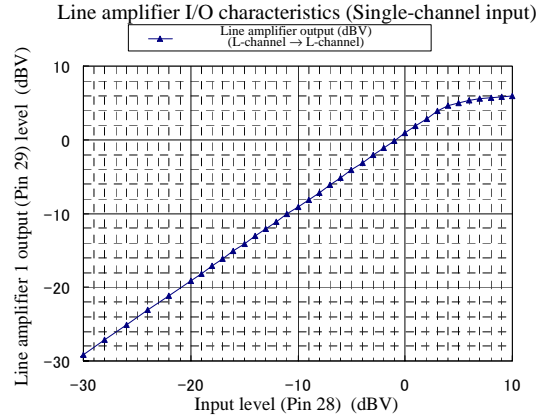
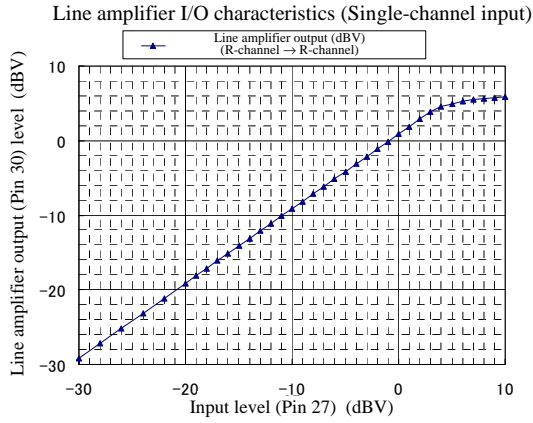

$V_{CC} = 5.0\text{ V}$, $V_{CC-SP} = 5.0\text{ V}$, $f_{req} = 1\text{ kHz}$, $R_L = 10\text{ k}\Omega$, $R_L(HP) = 100\ \Omega$, $EVR = 3.3\text{ V}$, Automatic detection on, HPF: 400 Hz, LPF: 30 kHz

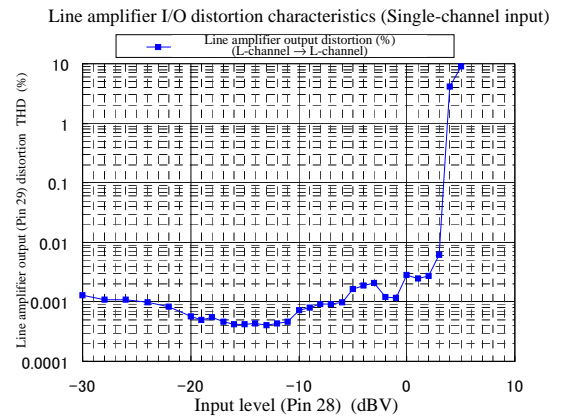
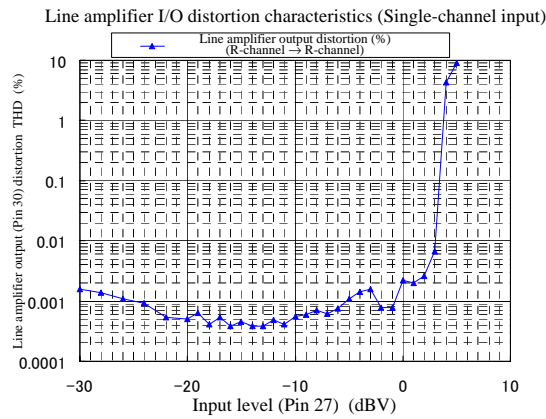

$V_{CC} = 5.0\text{ V}$, $V_{CC-SP} = 5.0\text{ V}$, $V_{IN} = -10\text{ dBV}$, $R_L = 10\text{ k}\Omega$, $R_L(HP) = 100\ \Omega$, $EVR = 3.3\text{ V}$, Automatic detection on

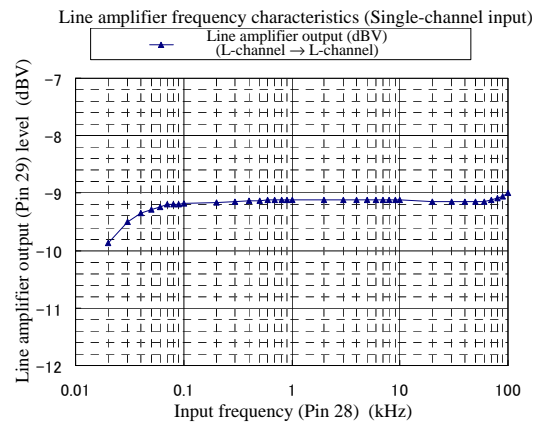
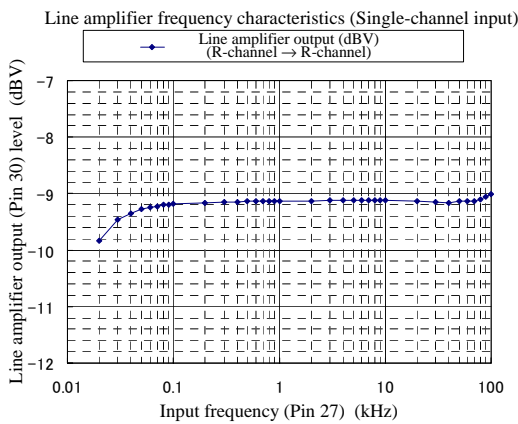

■ Technical Data (continued)

- Main characteristics (continued)

3) Line amplifier (continued)

$V_{CC} = 5.0\text{ V}$, $V_{CC-SP} = 5.0\text{ V}$, $V_{IN} = -10\text{ dBV}$, $R_L = 10\text{ k}\Omega$, $R_L(HP) = 100\ \Omega$, $EVR = 3.3\text{ V}$, Automatic detection on, LPF: 30 kHz (20 kHz to 1 kHz), LPF: 80 kHz (2 kHz to 10 kHz)

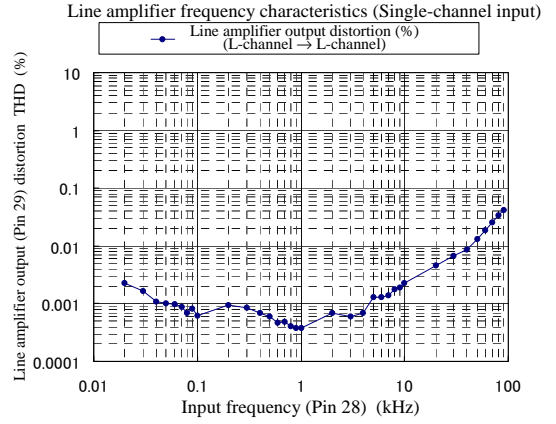
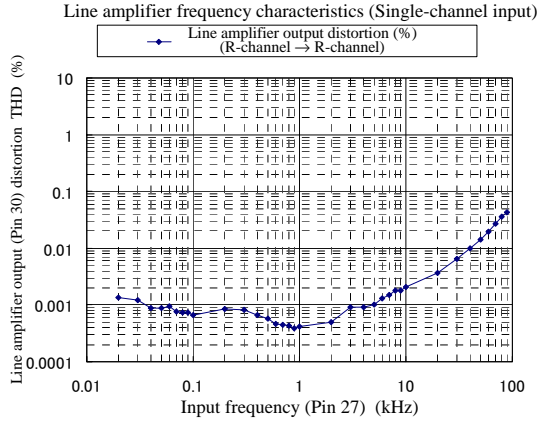

$V_{CC} = 5.0\text{ V}$, $V_{CC-SP} = 5.0\text{ V}$, $V_{IN} = -10\text{ dBV}$, $R_L = 10\text{ k}\Omega$, $R_L(HP) = 100\ \Omega$, $EVR = 3.3\text{ V}$, Automatic detection on, 30 kHz: LPF

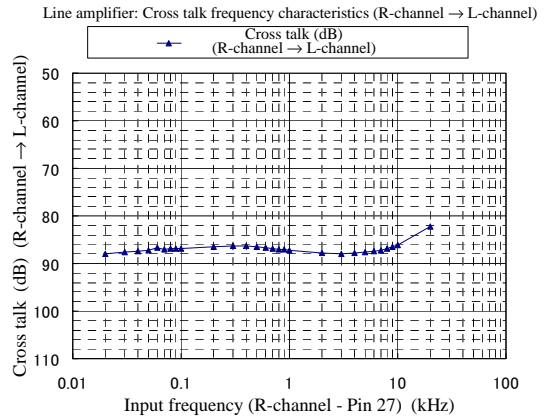
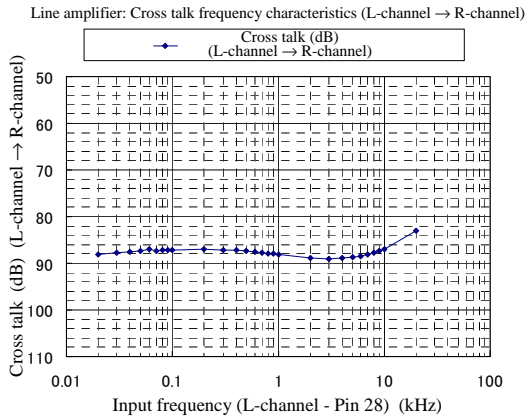

■ Technical Data (continued)

- Main characteristics (continued)

4) EVR

$V_{CC} = 5.0\text{ V}$, $V_{CC-SP} = 5.0\text{ V}$, $V_{IN} = -10\text{ dBV}$, $f_{req} = 1\text{ kHz}$, $R_{OUT} = 100\ \Omega$, Automatic detection on, HPF: 400 Hz, LPF: 30 kHz

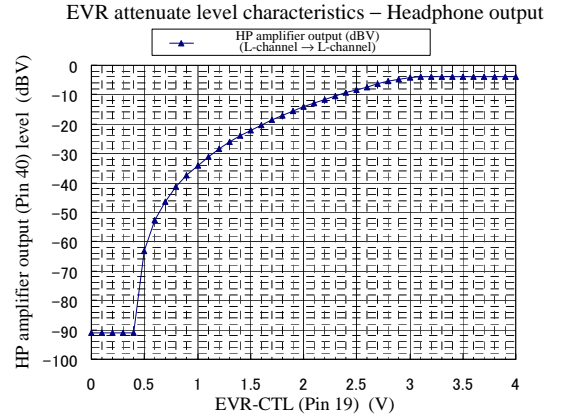
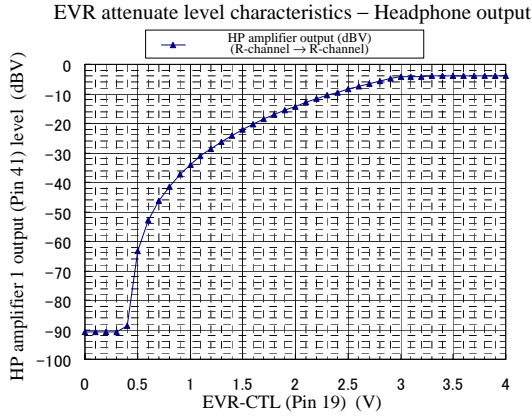

$V_{CC} = 5.0\text{ V}$, $V_{CC-SP} = 5.0\text{ V}$, $V_{IN} = -10\text{ dBV}$, $f_{req} = 1\text{ kHz}$, $R_{OUT} = 100\ \Omega$, Automatic detection on, HPF: 400 Hz, LPF: 30 kHz

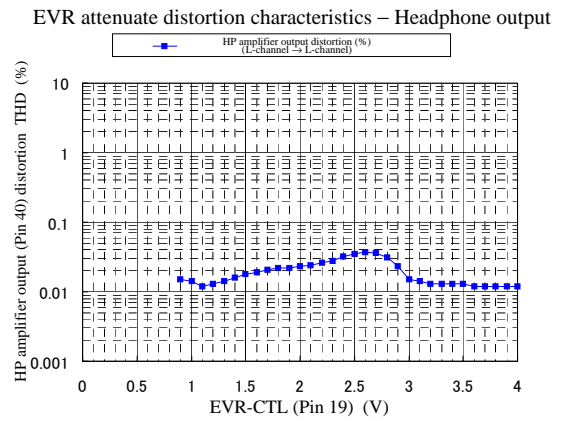
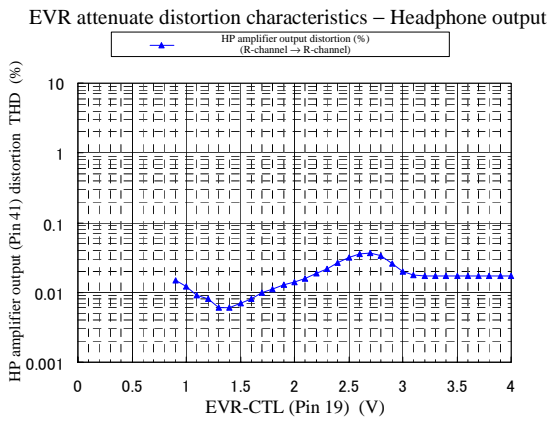

■ Technical Data (continued)

- Main characteristics (continued)

5) Beep

$V_{CC} = 5.0\text{ V}$, $V_{CC-SP} = 5.0\text{ V}$, $f_{req} = 1\text{ kHz}$, Input resistance = $10\text{ k}\Omega$, Square wave, EVR = 3.3 V (max), Automatic detection on

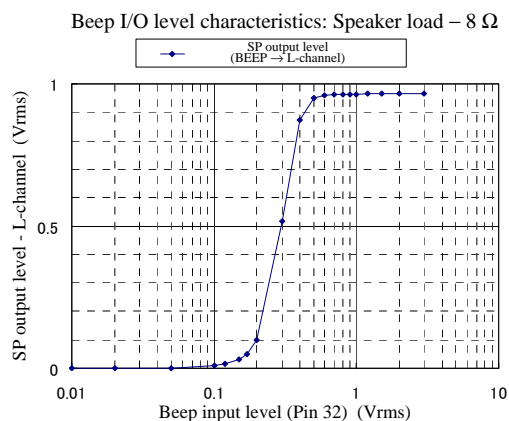
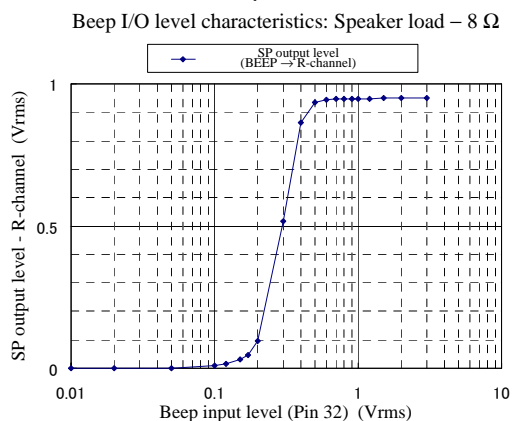

$V_{CC} = 5.0\text{ V}$, $V_{CC-SP} = 5.0\text{ V}$, $V_{IN} = 1.0\text{ Vrms}$, Input resistance = $10\text{ k}\Omega$, Square wave, EVR = 3.3 V (max), Automatic detection on

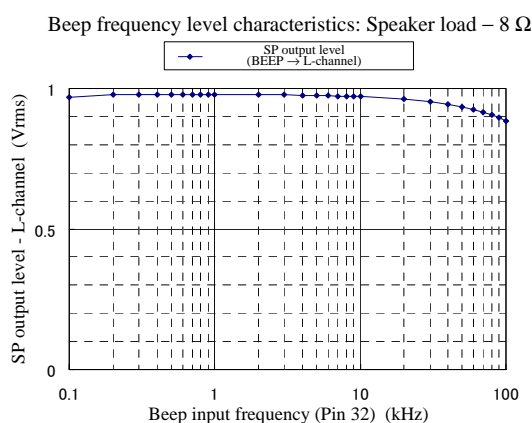
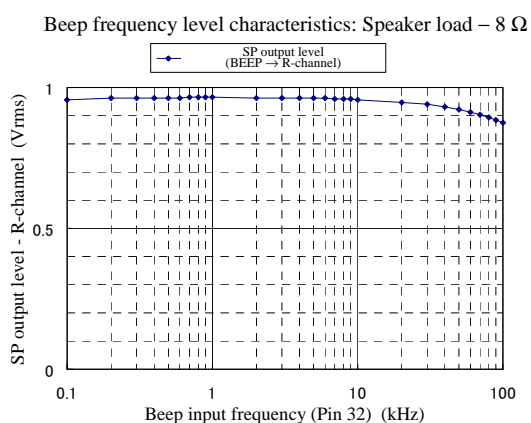

■ Technical Data (continued)

- Main characteristics (continued)

6) Signal detection preamplifier

$V_{CC} = 5.0\text{ V}$, $V_{CC-SP} = 5.0\text{ V}$, $f_{req} = 1\text{ kHz}$, R-channel IN, EVR = 3.3 V, HPF: 400 Hz, LPF: 30 kHz

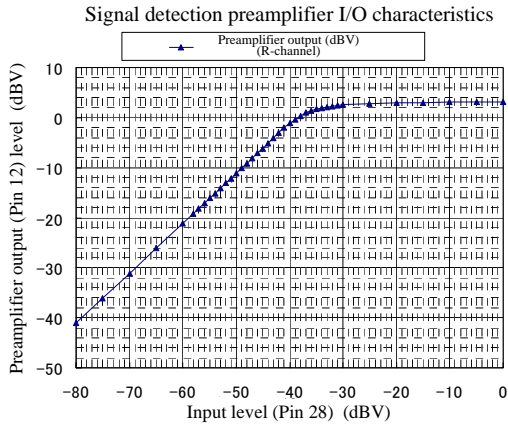

$V_{CC} = 5.0\text{ V}$, $V_{CC-SP} = 5.0\text{ V}$, $f_{req} = 1\text{ kHz}$, L-channel IN, EVR = 3.3 V, HPF: 400 Hz, LPF: 30 kHz

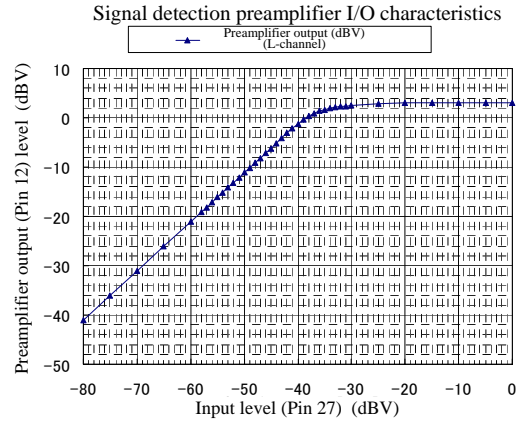

$V_{CC} = 5.0\text{ V}$, $V_{CC-SP} = 5.0\text{ V}$, $V_{IN} = -49\text{ dBV}$, R-channel IN, RVR = 3.3 V

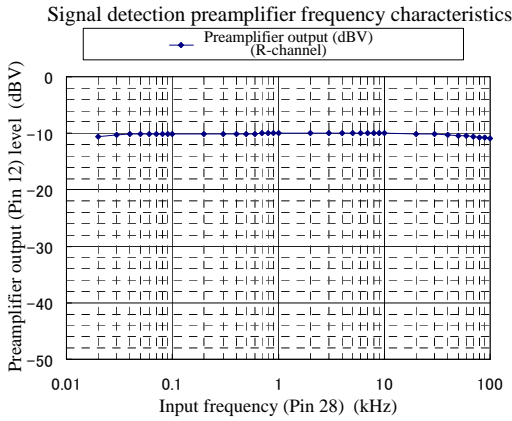

$V_{CC} = 5.0\text{ V}$, $V_{CC-SP} = 5.0\text{ V}$, $V_{IN} = -49\text{ dBV}$, L-channel IN, EVR = 3.3 V

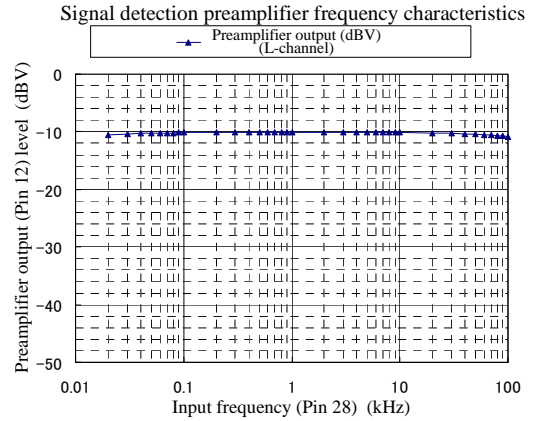

$V_{CC} = 5.0\text{ V}$, $V_{CC-SP} = 5.0\text{ V}$, $V_{IN} = -49\text{ dBV}$, R-channel IN, EVR = 3.3 V, LPF: R = 20 kΩ, C = 2 200 pF

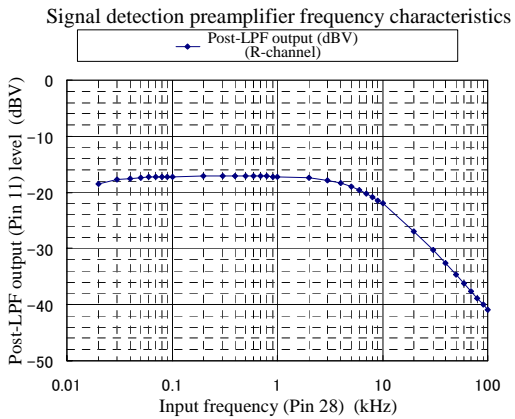

$V_{CC} = 5.0\text{ V}$, $V_{CC-SP} = 5.0\text{ V}$, $V_{IN} = -49\text{ dBV}$, L-channel IN, EVR = 3.3 V, LPF: R = 20 kΩ, C = 2 200 pF

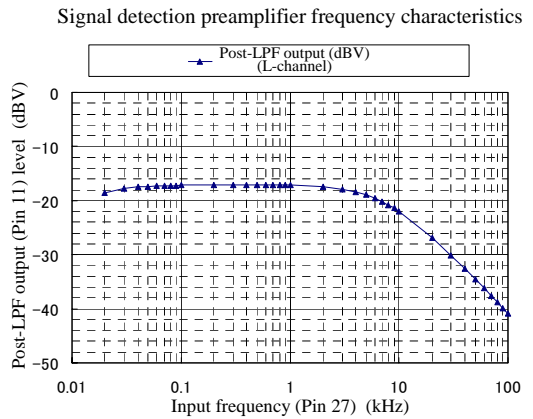

■ Technical Data (continued)

• Main characteristics (continued)

7) Signal detection threshold value

$V_{CC} = 5.0V$, $V_{CC_SP} = 5.0 V$, $f_{req} = 1 kHz$, RC constants between pin 11 and pin 12: $R = 20 k\Omega$, $C = 2 200 pF$, Signal: LINE input (pin 27), SP input: $24 k\Omega$ -ATT, HPF: 400 Hz, LPF: 30 kHz

SP-SAVE characteristics (R-channel input)

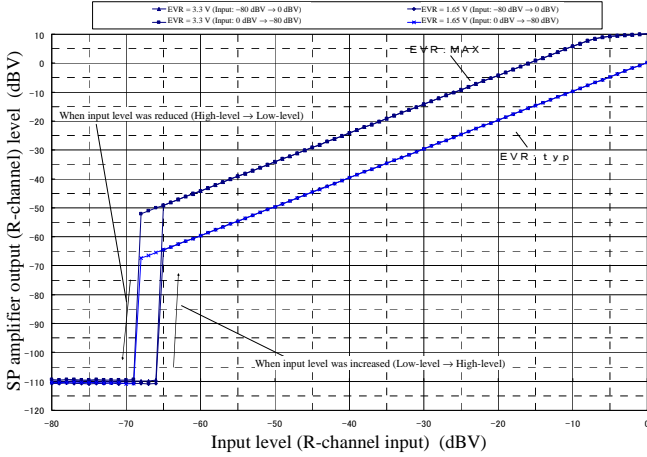

$V_{CC} = 5.0V$, $V_{CC_SP} = 5.0 V$, $f_{req} = 1 kHz$, RC constants between pin 11 and pin 12: $R = 20 k\Omega$, $C = 2 200 pF$, Signal: LINE input (pin 28), SP input: $24 k\Omega$ -ATT, HPF: 400 Hz, LPF: 30 kHz

SP-SAVE characteristics (L-channel input)

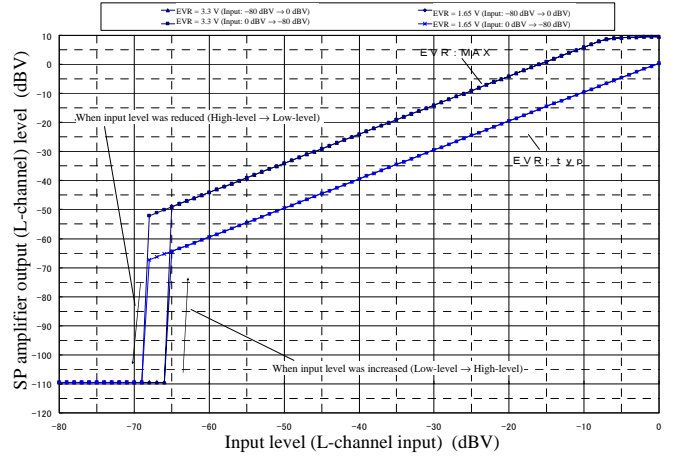

8) Mode switching

$V_{CC} = 5.0 V$, $V_{CC_SP} = 5.0 V$, $V_{IN} = -10 dBV$, $f_{req} = 1 kHz$, R-channel input, $R_L = 8 \Omega$, HP_JACK = 5 V, EVR = 3.3 V

SPK_MUTE on/off

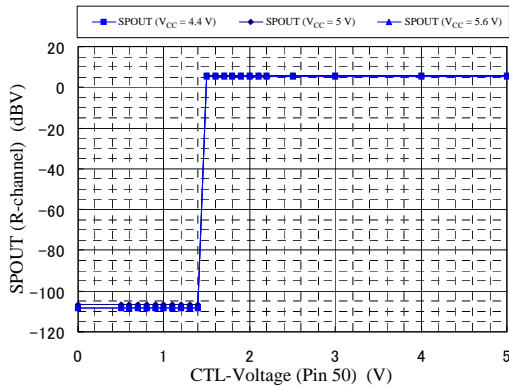

$V_{CC} = 5.0 V$, $V_{CC_SP} = 5.0 V$, $V_{IN} = -10 dBV$, $f_{req} = 1 kHz$, R-channel input, $R_L = 8 \Omega$, SPK_MUTE = 5 V, EVR = 3.3 V

HP_JACK on/off

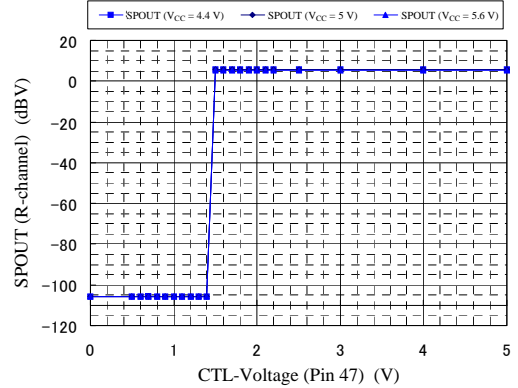

■ Technical Data (continued)

- Main characteristics (continued)

8) Mode switching (continued)

$V_{CC} = 5.0\text{ V}$, $V_{CC_SP} = 5.0\text{ V}$, $V_{IN} = -49\text{ dBV}$, $f_{req} = 1\text{ kHz}$,
R-channel input, EVR = 3.3 V

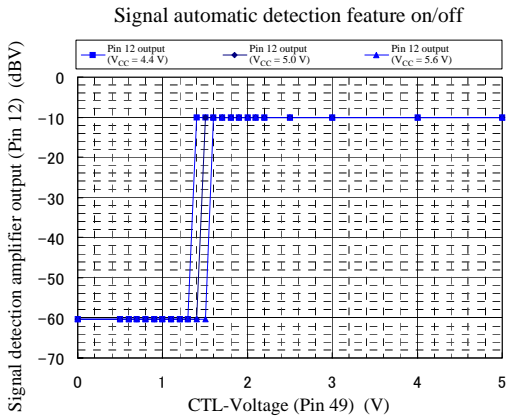

$V_{CC} = 5.0\text{ V}$, $V_{CC_SP} = 5.0\text{ V}$, Automatic distinction off, SP-SAVE = On, EVR = 0 V

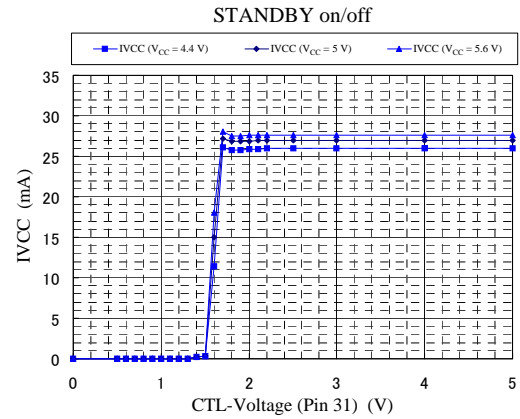

$V_{CC} = 5.0\text{ V}$, $V_{CC_SP} = 5.0\text{ V}$, $BV_{REF} = 2.5\text{ V}$, $V_{IN} = -10\text{ dBV}$, $f = 1\text{ kHz}$

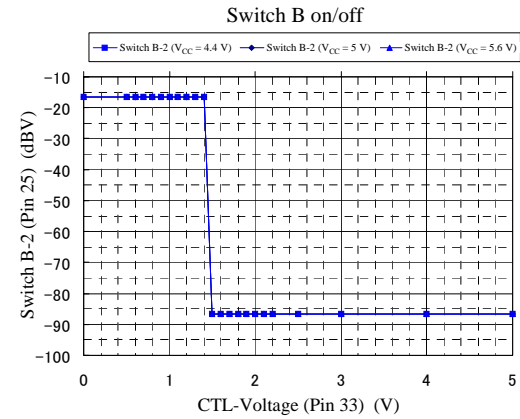
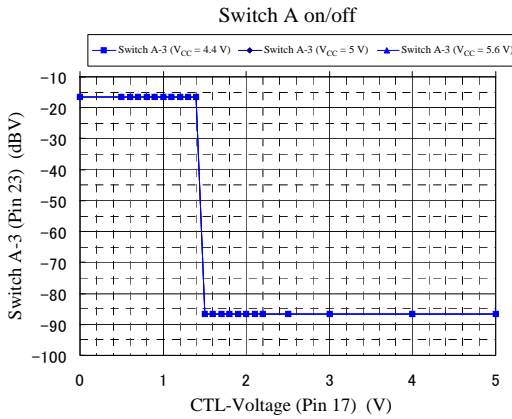

- Switch A MODE-CTL measurement diagram

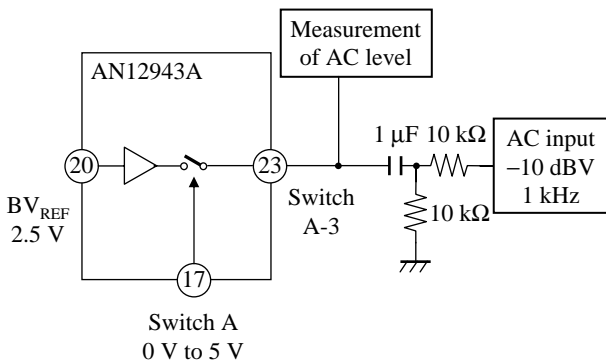

- Switch B MODE-CTL measurement diagram

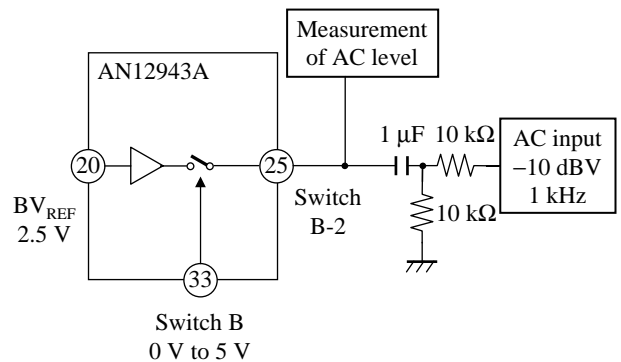

Request for your special attention and precautions in using the technical information and semiconductors described in this material

- (1) An export permit needs to be obtained from the competent authorities of the Japanese Government if any of the products or technical information described in this material and controlled under the "Foreign Exchange and Foreign Trade Law" is to be exported or taken out of Japan.
- (2) The technical information described in this material is limited to showing representative characteristics and applied circuits examples of the products. It neither warrants non-infringement of intellectual property right or any other rights owned by our company or a third party, nor grants any license.
- (3) We are not liable for the infringement of rights owned by a third party arising out of the use of the technical information as described in this material.
- (4) The products described in this material are intended to be used for standard applications or general electronic equipment (such as office equipment, communications equipment, measuring instruments and household appliances).
Consult our sales staff in advance for information on the following applications:
 - Special applications (such as for airplanes, aerospace, automobiles, traffic control equipment, combustion equipment, life support systems and safety devices) in which exceptional quality and reliability are required, or if the failure or malfunction of the products may directly jeopardize life or harm the human body.
 - Any applications other than the standard applications intended.
- (5) The products and product specifications described in this material are subject to change without notice for modification and/or improvement. At the final stage of your design, purchasing, or use of the products, therefore, ask for the most up-to-date Product Standards in advance to make sure that the latest specifications satisfy your requirements.
- (6) When designing your equipment, comply with the guaranteed values, in particular those of maximum rating, the range of operating power supply voltage, and heat radiation characteristics. Otherwise, we will not be liable for any defect which may arise later in your equipment.
Even when the products are used within the guaranteed values, take into the consideration of incidence of break down and failure mode, possible to occur to semiconductor products. Measures on the systems such as redundant design, arresting the spread of fire or preventing glitch are recommended in order to prevent physical injury, fire, social damages, for example, by using the products.
- (7) When using products for which damp-proof packing is required, observe the conditions (including shelf life and amount of time let standing of unsealed items) agreed upon when specification sheets are individually exchanged.
- (8) This material may be not reprinted or reproduced whether wholly or partially, without the prior written permission of Matsushita Electric Industrial Co., Ltd.



LittleDiode supplies new, hard to find or obsolete electronic components and semiconductors all over the world.

With over two million different components listed you are sure to find the part you need.

Feel free to visit us today at our online store:

LittleDiode.com

Looking forward to providing you with the best possible service.