

RF & MICROWAVE TRANSISTORS S-BAND RADAR APPLICATIONS

- REFRACTORY/GOLD METALLIZATION
- EMITTER SITE BALLASTED
- RUGGEDIZED VSWR 3:1 @ 1dB OVERDRIVE
- LOW THERMAL RESISTANCE
- INPUT/OUTPUT MATCHING
- OVERLAY GEOMETRY
- METAL/CERAMIC HERMETIC PACKAGE
- P_{OUT} = 50 W MIN. WITH 5.2 dB GAIN

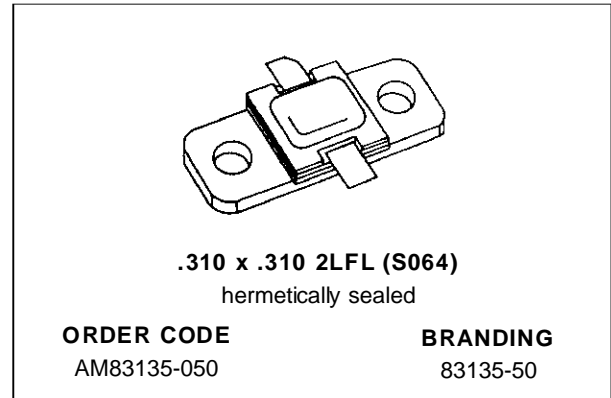

DESCRIPTION

The AM83135-050 device is a high power silicon bipolar NPN transistor specifically designed for S-Band radar pulsed output and driver applications.

This device is characterized at 10 μsec pulsewidth and 10% duty cycle, but is capable of operation over a range of pulse widths, duty cycles and temperatures and can withstand a 3:1 output VSWR with a +1 dB input overdrive. Low RF thermal resistance, refractory/gold metallization, and computerized automatic wire bonding techniques ensure high reliability and product consistency (including phase characteristics).

The AM83135-050 is supplied in the IMPAC™ Hermetic Metal/Ceramic package with internal Input/Output impedance matching circuitry, and is intended for military and other high reliability applications.

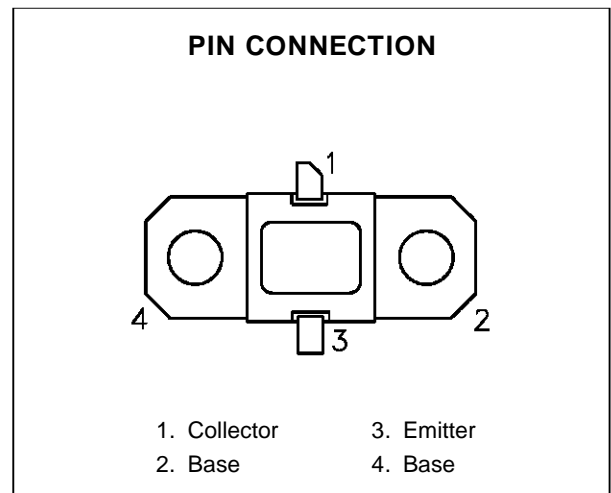

ABSOLUTE MAXIMUM RATINGS (T_{case} = 25°C)

Symbol	Parameter	Value	Unit
P _{DISS}	Power Dissipation* (T _C ≤ 125°C)	312	W
I _C	Device Current*	8.0	A
V _{CC}	Collector-Supply Voltage*	48	V
T _J	Junction Temperature (Pulsed RF Operation)	250	°C
T _{STG}	Storage Temperature	- 65 to +200	°C

THERMAL DATA

R _{TH(j-c)}	Junction-Case Thermal Resistance*	0.40	°C/W
----------------------	-----------------------------------	------	------

*Applies only to rated RF amplifier operation

ELECTRICAL SPECIFICATIONS ($T_{case} = 25^{\circ}C$)

STATIC

Symbol	Test Conditions			Value			Unit
				Min.	Typ.	Max.	
BV_{CBO}	$I_C = 25mA$	$I_E = 0mA$		55	—	—	V
BV_{EBO}	$I_E = 5mA$	$I_C = 0mA$		3.5	—	—	V
BV_{CER}	$I_C = 25mA$	$R_{BE} = 10W$		55	—	—	V
I_{CES}	$V_{BE} = 0V$	$V_{CE} = 42V$		—	—	20	mA
h_{FE}	$V_{CE} = 5V$	$I_C = 3A$		30	—	300	—

DYNAMIC

Symbol	Test Conditions			Value			Unit
				Min.	Typ.	Max.	
P_{OUT}	$f = 3.1 - 3.5GHz$	$P_{IN} = 15W$	$V_{CC} = 42V$	50	—	—	W
η_C	$f = 3.1 - 3.5GHz$	$P_{IN} = 15W$	$V_{CC} = 42V$	30	—	—	%
G_P	$f = 3.1 - 3.5GHz$	$P_{IN} = 15W$	$V_{CC} = 42V$	5.2	—	—	dB

Note: Pulse Width = 10 μ Sec
 Duty Cycle = 10%

TYPICAL PERFORMANCE

OUTPUT POWER vs FREQUENCY

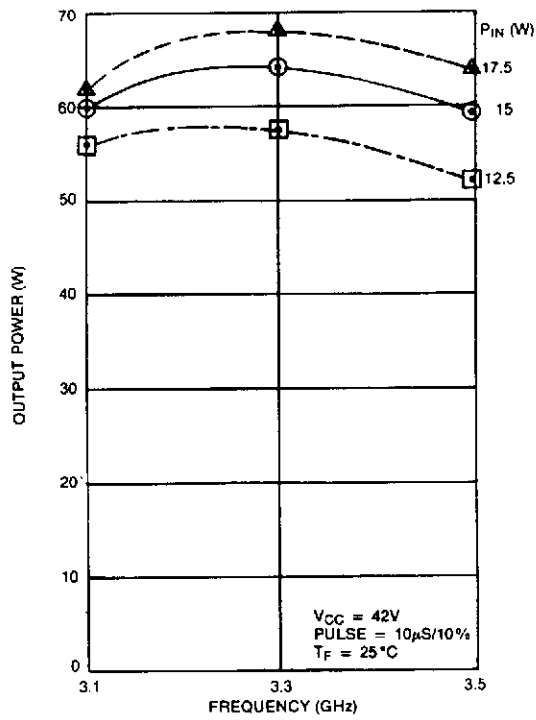

COLLECTOR EFFICIENCY vs COLLECTOR SUPPLY VOLTAGE

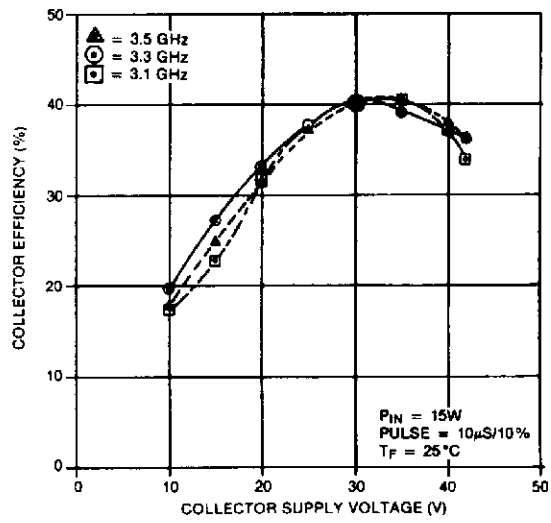

OUTPUT POWER vs COLLECTOR SUPPLY VOLTAGE

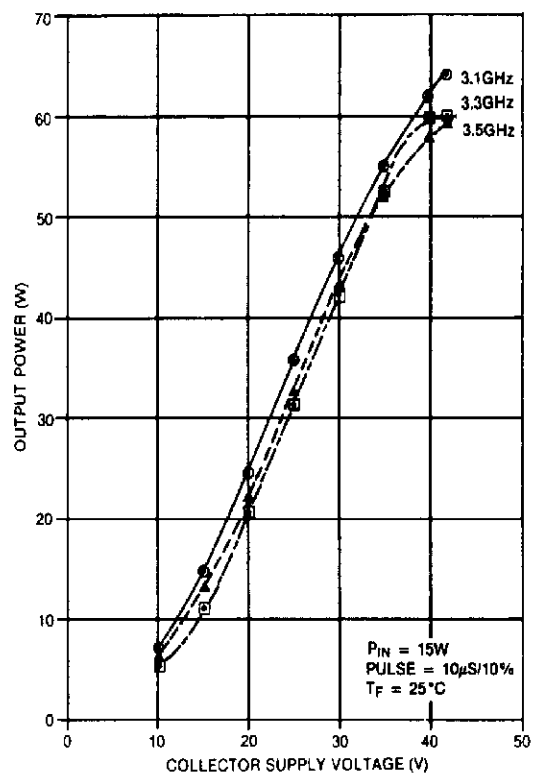

COLLECTOR EFFICIENCY vs FREQUENCY

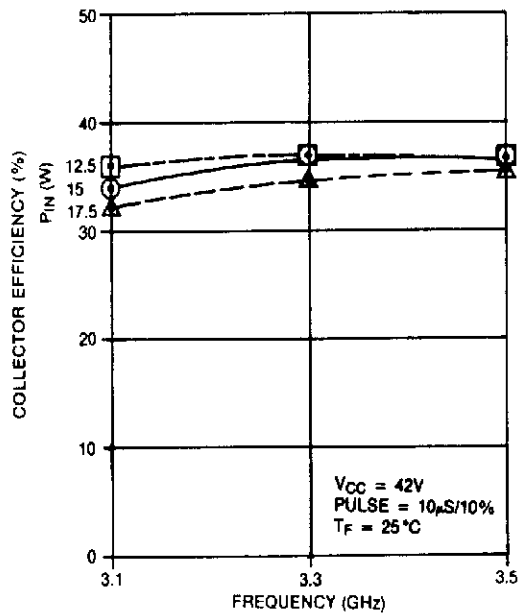

IMPEDANCE DATA

TYPICAL INPUT IMPEDANCE

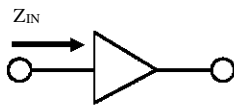

$P_{IN} = 15\text{ W}$
 $V_{CC} = 42\text{ V}$
 $Z_{O}^* = 50\text{ ohms}$

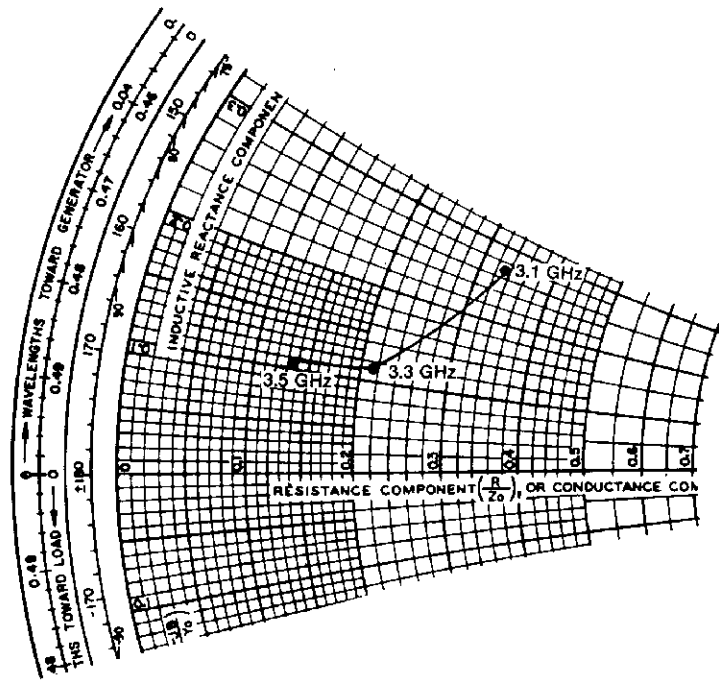

FREQ.	$Z_{IN} (\Omega)$	$Z_{CL} (\Omega)$
L = 3.1 GHz	$16.5 + j 13.5$	$7.7 - j 11.8$
M = 3.3 GHz	$10.8 + j 5.5$	$6.5 - j 7.2$
H = 3.5 GHz	$6.7 + j 5.2$	$3.8 - j 6.7$

TYPICAL COLLECTOR LOAD IMPEDANCE

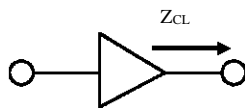

$P_{IN} = 15\text{ W}$
 $V_{CC} = 42\text{ V}$
 $Z_{O}^* = 50\text{ ohms}$

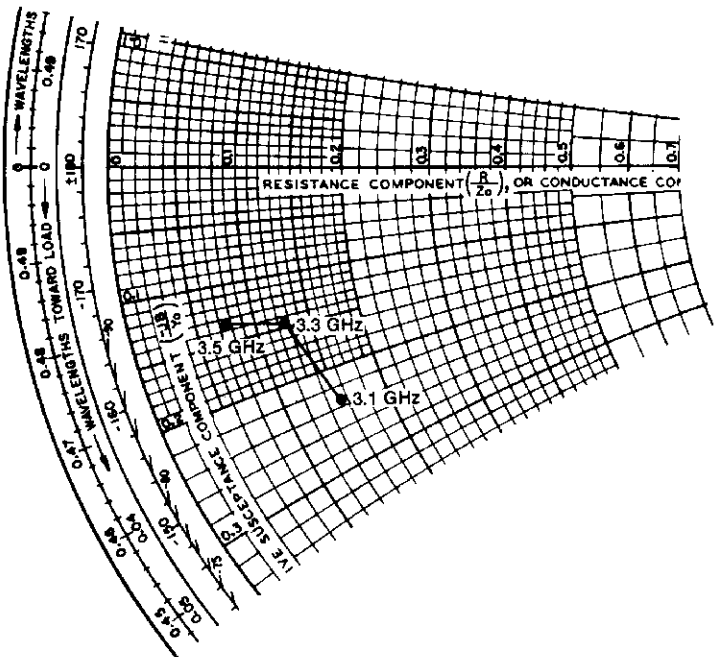

*Normalized

PACKAGE MECHANICAL DATA

Ref.: Dwg. No. 12-0221
UDCS No. 1011424 rev A

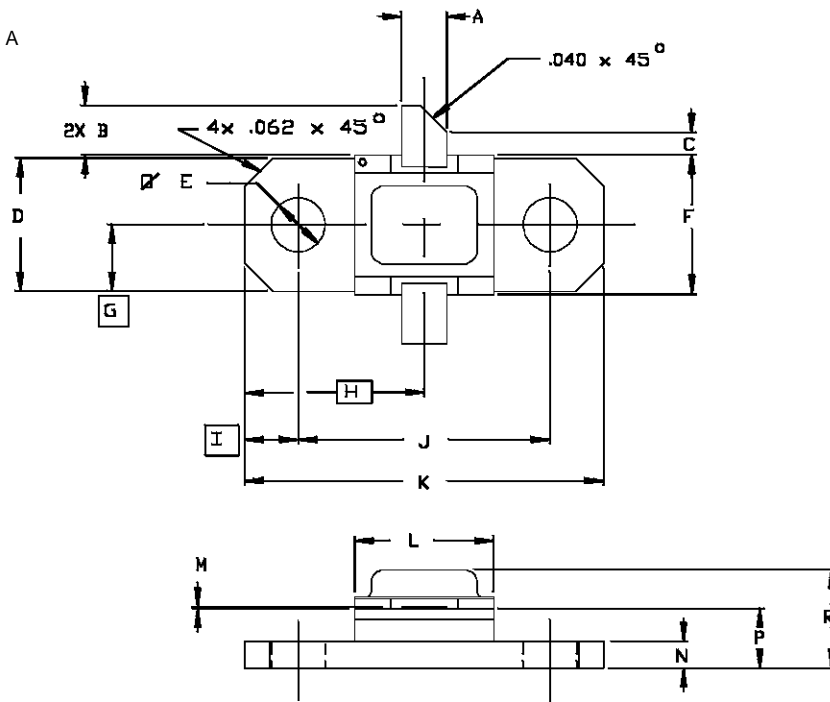

SGS-THOMSON MICROELECTRONICS			CONT'D		
	MINIMUM Inches/mm	MAXIMUM Inches/mm		MINIMUM Inches/mm	MAXIMUM Inches/mm
A	.095/2,41	.105/2,67	K	.790/20,07	.810/20,57
B	.100/2,54	.120/3,05	L	.300/7,62	.320/8,13
C	.050/1,27		M	.003/0,08	.006/0,15
D	.286/7,26	.306/7,77	N	.052/1,32	.072/1,83
E	.110/2,79	.130/3,30	P	.118/3,00	.131/3,33
F	.306/7,77	.318/8,08	R		.230/5,84
G	.148/3,76				
H	.400/10,16				
I	.119/3,02				
J	.552/14,02	.572/14,53			

Information furnished is believed to be accurate and reliable. However, SGS-THOMSON Microelectronics assumes no responsibility for the consequences of use of such information nor for any infringement of patents or other rights of third parties which may result from its use. No license is granted by implication or otherwise under any patent or patent rights of SGS-THOMSON Microelectronics. Specifications mentioned in this publication are subject to change without notice. This publication supersedes and replaces all information previously supplied. SGS-THOMSON Microelectronics products are not authorized for use as critical components in life support devices or systems without express written approval of SGS-THOMSON Microelectronics.

©1996 SGS-THOMSON Microelectronics - All Rights Reserved

SGS-THOMSON Microelectronics GROUP OF COMPANIES

Australia - Brazil - Canada - China - France - Germany - Hong Kong - Italy - Japan - Korea
Malaysia - Malta - Morocco - The Netherlands - Singapore - Spain - Sweden - Switzerland
Taiwan - Thailand - United Kingdom - U.S.A.



LittleDiode supplies new, hard to find or obsolete electronic components and semiconductors all over the world.

With over two million different components listed you are sure to find the part you need.

Feel free to visit us today at our online store:

LittleDiode.com

Looking forward to providing you with the best possible service.