

SMALL SIGNAL SCHOTTKY DIODE

DESCRIPTION

General purpose, metal to silicon diodes featuring very low turn-on voltage and fast switching.

These devices have integrated protection against excessive voltage such as electrostatic discharges.

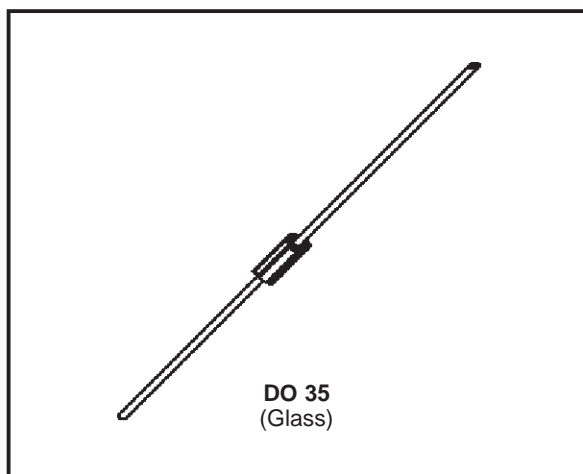

ABSOLUTE RATINGS (limiting values)

Symbol	Parameter		BAT47	BAT48	Unit
V_{RRM}	Repetitive Peak Reverse Voltage		20	40	V
I_F	Forward Continuous Current*	$T_a = 25\text{ °C}$	350		mA
I_{FRM}	Repetitive Peak Forward Current*	$t_p \leq 1\text{ s}$ $\delta \leq 0.5$	1		A
I_{FSM}	Surge non Repetitive Forward Current*	$t_p = 10\text{ ms}$	7.5		A
		$t_p = 1\text{ s}$	1.5		
P_{tot}	Power Dissipation*	$T_a = 25\text{ °C}$	330		mW
T_{stg} T_j	Storage and Junction Temperature Range		- 65 to + 150		°C
			- 65 to + 125		°C
T_L	Maximum Temperature for Soldering during 10s at 4mm from Case		230		°C

THERMAL RESISTANCE

Symbol	Test Conditions	Value	Unit
$R_{th(j-l)}$	Junction-ambient*	300	°C/W

* On infinite heatsink with 4mm lead length

ELECTRICAL CHARACTERISTICS
STATIC CHARACTERISTICS

Symbol	Test Conditions		Min.	Typ.	Max.	Unit	
$V_{(BR)}$	$I_R = 10\mu A$	BAT47	20			V	
	$I_R = 25\mu A$	BAT48	40				
V_F^*	$T_j = 25^\circ C$ $I_F = 0.1mA$	All Types			0.25	V	
	$T_j = 25^\circ C$ $I_F = 1mA$				0.3		
	$T_j = 25^\circ C$ $I_F = 10mA$				0.4		
	$T_j = 25^\circ C$ $I_F = 30mA$	BAT47			0.5		
	$T_j = 25^\circ C$ $I_F = 150mA$				0.8		
	$T_j = 25^\circ C$ $I_F = 300mA$				1		
	$T_j = 25^\circ C$ $I_F = 50mA$	BAT48			0.5		
	$T_j = 25^\circ C$ $I_F = 200mA$				0.75		
	$T_j = 25^\circ C$ $I_F = 500mA$				0.9		
I_R^*	$T_j = 25^\circ C$	$V_R = 1.5V$	All Types			1	μA
	$T_j = 60^\circ C$					10	
	$T_j = 25^\circ C$	$V_R = 10V$	BAT47			4	
	$T_j = 60^\circ C$					20	
	$T_j = 25^\circ C$	$V_R = 20V$				10	
	$T_j = 60^\circ C$					30	
	$T_j = 25^\circ C$	$V_R = 10V$	BAT48			2	
	$T_j = 60^\circ C$					15	
	$T_j = 25^\circ C$	$V_R = 20V$				5	
	$T_j = 60^\circ C$					25	
	$T_j = 25^\circ C$	$V_R = 40V$				25	
	$T_j = 60^\circ C$					50	

DYNAMIC CHARACTERISTICS

Symbol	Test Conditions		Min.	Typ.	Max.	Unit
C	$T_j = 25^\circ C$ $V_R = 0V$	f = 1MHz		20		pF
	$T_j = 25^\circ C$ $V_R = 1V$			12		
t_{rr}	$T_j = 25^\circ C$ $I_F = 10mA$	$V_R = 1V$ $i_{rr} = 1mA$ $R_L = 100\Omega$		10		ns

* Pulse test: $t_p \leq 300\mu s$ $\delta < 2\%$.

Figure 1. Forward current versus forward voltage at different temperatures (typical values).

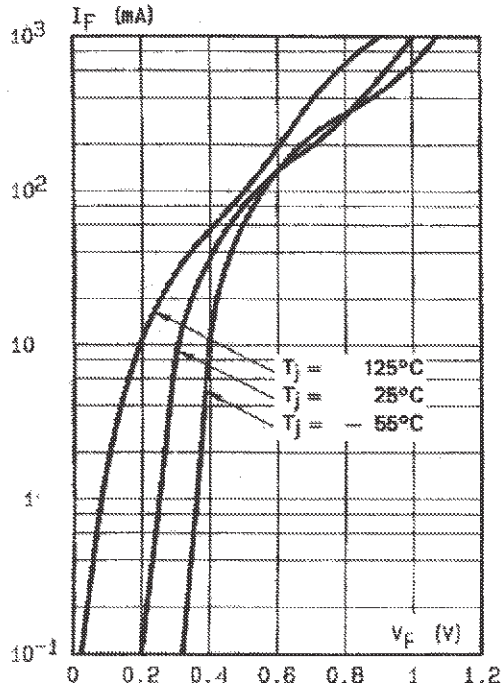

Figure 2. Forward current versus forward voltage (typical values).

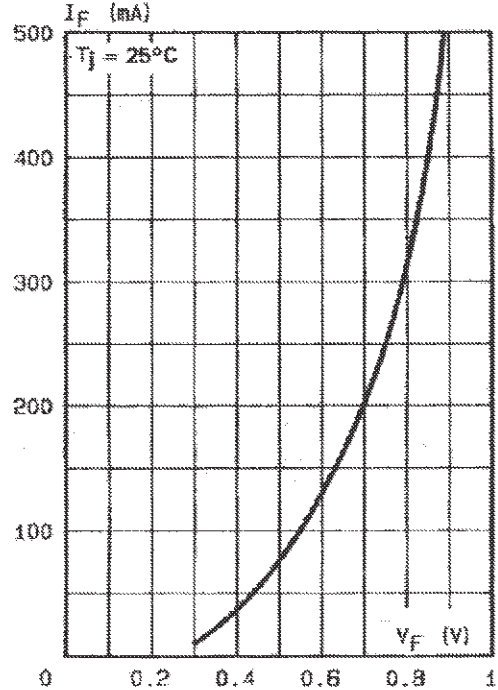

Figure 3. Reverse current versus junction temperature.

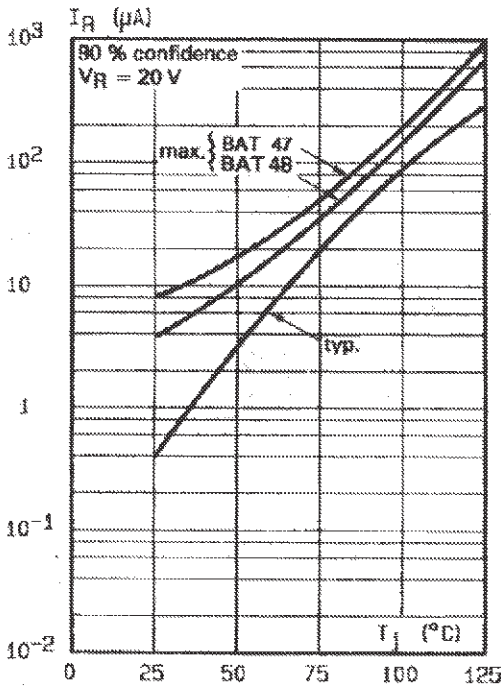

Figure 4. Reverse current versus continuous reverse voltage (typical values).

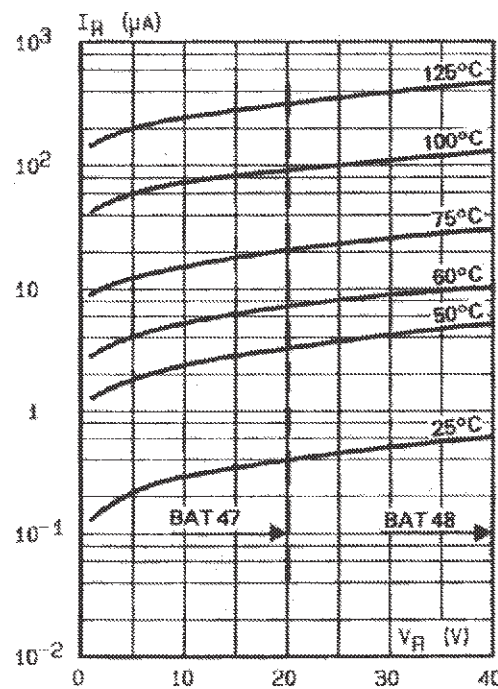
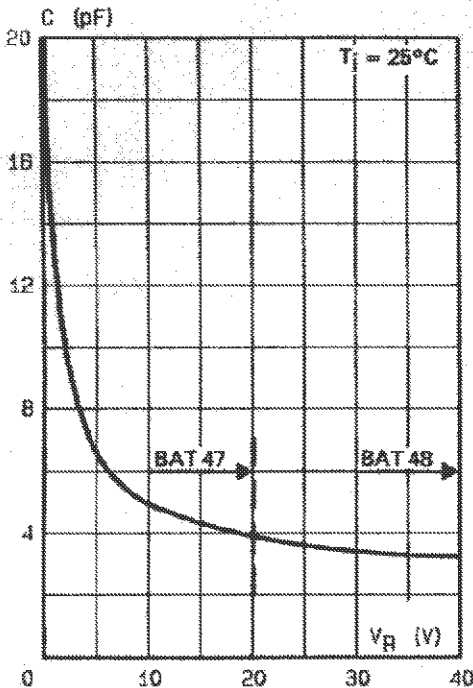
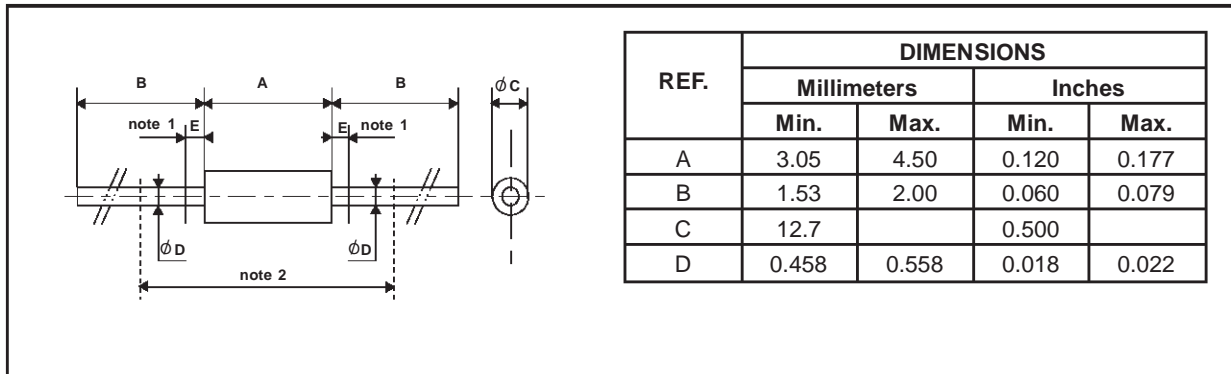

Figure 5. Capacitance C versus reverse



PACKAGE MECHANICAL DATA

DO 35 Glass



Cooling method: by convection and conduction.
 Marking: clear, ring at cathode end.
 Weight: 0.015g

Information furnished is believed to be accurate and reliable. However, STMicroelectronics assumes no responsibility for the consequences of use of such information nor for any infringement of patents or other rights of third parties which may result from its use. No license is granted by implication or otherwise under any patent or patent rights of STMicroelectronics. Specifications mentioned in this publication are subject to change without notice. This publication supersedes and replaces all information previously supplied. STMicroelectronics products are not authorized for use as critical components in life support devices or systems without express written approval of STMicroelectronics.

The ST logo is a registered trademark of STMicroelectronics
 © 1999 STMicroelectronics - Printed in Italy - All rights reserved.

STMicroelectronics GROUP OF COMPANIES
 Australia - Brazil - China - Finland - France - Germany - Hong Kong - India - Italy - Japan - Malaysia
 Malta - Morocco - Singapore - Spain - Sweden - Switzerland - United Kingdom - U.S.A.

<http://www.st.com>



LittleDiode supplies new, hard to find or obsolete electronic components and semiconductors all over the world.

With over two million different components listed you are sure to find the part you need.

Feel free to visit us today at our online store:

LittleDiode.com

Looking forward to providing you with the best possible service.