

74F675A

16-Bit Serial-In, Serial/Parallel-Out Shift Register

General Description

The 74F675A contains a 16-bit serial in/serial out shift register and a 16-bit parallel out storage register. Separate serial input and output pins are provided for expansion to longer words. By means of a separate clock, the contents of the shift register are transferred to the storage register. The contents of the storage register can also be loaded back into the shift register. A HIGH signal on the Chip Select input prevents both shifting and parallel loading.

Features

- Serial-to-parallel converter
- 16-Bit serial I/O shift register
- 16-Bit parallel out storage register
- Recirculating parallel transfer
- Expandable for longer words
- Slim 24 lead package
- 74F675A version prevents false clocking through CS or R/W inputs

Ordering Code:

Order Number	Package Number	Package Description
74F675ASC	M24B	24-Lead Small Outline Integrated Circuit (SOIC), JEDEC MS-013, 0.300 Wide
74F675APC	N24A	24-Lead Plastic Dual-In-Line Package (PDIP), JEDEC MS-011, 0.600 Wide
74F675ASPC	N24C	24-Lead Plastic Dual-In-Line Package (PDIP), JEDEC MS-001, 0.300 Wide

Devices also available in Tape and Reel. Specify by appending the suffix letter "X" to the ordering code.

Logic Symbols

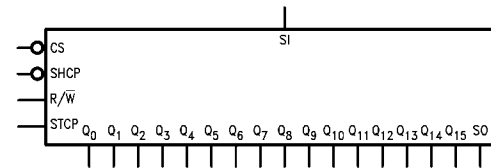
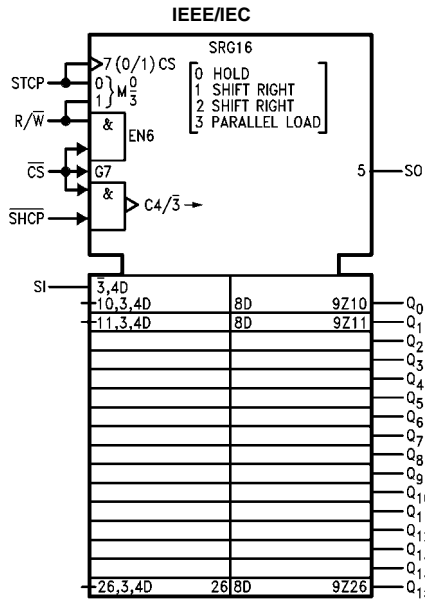

Connection Diagram

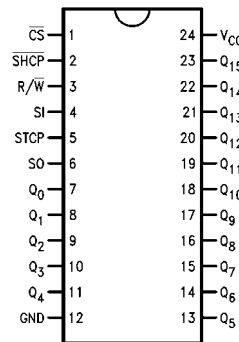

Unit Loading/Fan Out

Pin Names	Description	U.L.	
		HIGH/LOW	Input I_{IH}/I_{IL} Output I_{OH}/I_{OL}
SI	Serial Data Input	1.0/1.0	20 μ A/-0.6 mA
\overline{CS}	Chip Select Input (Active LOW)	1.0/1.0	20 μ A/-0.6 mA
\overline{SHCP}	Shift Clock Pulse Input (Active Falling Edge)	1.0/1.0	20 μ A/-0.6 mA
STCP	Store Clock Pulse Input (Active Rising Edge)	1.0/1.0	20 μ A/-0.6 mA
$\overline{R/\overline{W}}$	Read/Write Input	1.0/1.0	20 μ A/-0.6 mA
SO	Serial Data Output	50/33.3	-1 mA/20 mA
Q_0-Q_{15}	Parallel Data Outputs	50/33.3	-1 mA/20 mA

Functional Description

The 16-Bit shift register operates in one of four modes, as determined by the signals applied to the Chip Select (\overline{CS}), Read/Write ($\overline{R/\overline{W}}$) and Store Clock Pulse (STCP) input. State changes are indicated by the falling edge of the Shift Clock Pulse (\overline{SHCP}). In the Shift Right mode, data enters D_0 from the Serial Input (SI) pin and exits from Q_{15} via the Serial Data Output (SO) pin. In the Parallel Load mode, data from the storage register outputs enter the shift register and serial shifting is inhibited.

The storage register is in the Hold mode when either \overline{CS} or $\overline{R/\overline{W}}$ is HIGH. With \overline{CS} and $\overline{R/\overline{W}}$ both LOW, the storage register is parallel loaded from the shift register on the rising edge of STCP.

To prevent false clocking of the shift register, \overline{SHCP} should be in the LOW state during a LOW-to-HIGH transition of \overline{CS} . To prevent false clocking of the storage register, STCP should be LOW during a HIGH-to-LOW transition of \overline{CS} if $\overline{R/\overline{W}}$ is LOW, and should also be LOW during a HIGH-to-LOW transition of $\overline{R/\overline{W}}$ if \overline{CS} is LOW.

Shift Register Operations Table

Control Inputs				Operating Mode
\overline{CS}	$\overline{R/\overline{W}}$	\overline{SHCP}	STCP	
H	X	X	X	Hold
L	L	\sim	X	Shift Right
L	H	\sim	L	Shift Right
L	H	\sim	H	Parallel Load, No Shifting

Storage Register Operations Table

Inputs			Operating Mode
\overline{CS}	$\overline{R/\overline{W}}$	STCP	
H	X	X	Hold
L	H	X	Hold
L	L	\swarrow	Parallel Load

H = HIGH Voltage Level
L = LOW Voltage Level
X = Immaterial
 \sim = HIGH-to-LOW Transition
 \swarrow = LOW-to-HIGH Transition

Logic Diagram

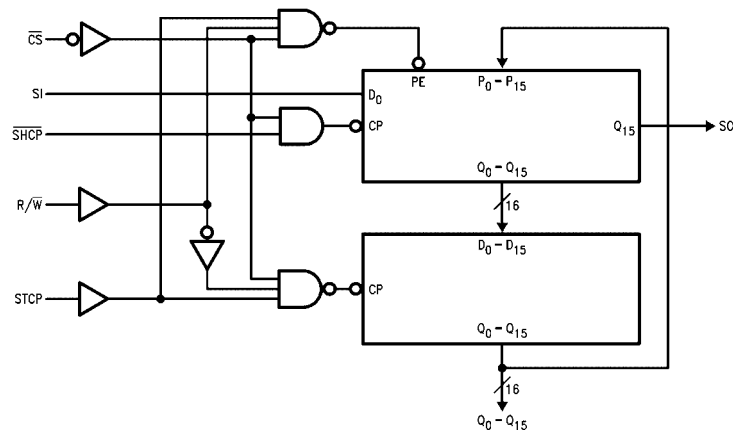

Please note that this diagram is provided only for the understanding of logic operations and should not be used to estimate propagation delays.

Absolute Maximum Ratings(Note 1)

Storage Temperature	-65°C to +150°C
Ambient Temperature under Bias	-55°C to +125°C
Junction Temperature under Bias	-55°C to +150°C
V _{CC} Pin Potential to Ground Pin	-0.5V to +7.0V
Input Voltage (Note 2)	-0.5V to +7.0V
Input Current (Note 2)	-30 mA to +5.0 mA

Voltage Applied to Output

in HIGH State (with V_{CC} = 0V)Standard Output -0.5V to V_{CC}

3-STATE Output -0.5V to +5.5V

Current Applied to Output

in LOW State (Max) twice the rated I_{OL} (mA)**Recommended Operating Conditions**

Free Air Ambient Temperature	0°C to +70°C
Supply Voltage	+4.5V to +5.5V

Note 1: Absolute maximum ratings are values beyond which the device may be damaged or have its useful life impaired. Functional operation under these conditions is not implied.

Note 2: Either voltage limit or current limit is sufficient to protect inputs.

DC Electrical Characteristics

Symbol	Parameter	Min	Typ	Max	Units	V _{CC}	Conditions
V _{IH}	Input HIGH Voltage	2.0			V		Recognized as a HIGH Signal
V _{IL}	Input LOW Voltage			0.8	V		Recognized as a LOW Signal
V _{CD}	Input Clamp Diode Voltage			-1.2	V	Min	I _{IN} = -18 mA
V _{OH}	Output HIGH Voltage	10% V _{CC} 5% V _{CC}	2.5 2.7		V	Min	I _{OH} = -1 mA I _{OH} = -1 mA
V _{OL}	Output LOW Voltage	10% V _{CC}		0.5	V	Min	I _{OL} = 20 mA
I _{IH}	Input HIGH Current			5.0	μA	Max	V _{IN} = 2.7V
I _{BVI}	Input HIGH Current Breakdown Test			7.0	μA	Max	V _{IN} = 7.0V
I _{CEX}	Output HIGH Leakage Current			50	μA	Max	V _{OUT} = V _{CC}
V _{ID}	Input Leakage Test	4.75			V	0.0	I _{ID} = 1.9 μA All Other Pins Grounded
I _{OD}	Output Leakage Circuit Current			3.75	μA	0.0	V _{IDP} = 150 mV All Other Pins Grounded
I _{IL}	Input LOW Current			-0.6	mA	Max	V _{IN} = 0.5V
I _{OS}	Output Short-Circuit Current	-60		-150	mA	Max	V _{OUT} = 0V
I _{CCH}	Power Supply Current		106	160	mA	Max	V _O = HIGH
I _{CCL}	Power Supply Current		106	160	mA	Max	V _O = LOW

AC Electrical Characteristics							
Symbol	Parameter	T _A = +25°C V _{CC} = +5.0V C _L = 50 pF			T _A = 0°C to +70°C V _{CC} = +5.0V C _L = 50 pF		Units
		Min	Typ	Max	Min	Max	
f _{MAX}	Maximum Clock Frequency	100	130		85		MHz
t _{PLH}	Propagation Delay	3.0	8.0	10.5	2.5	12.0	ns
t _{PHL}	STCP to Q _n	3.0	10.5	13.5	2.5	15.0	
t _{PLH}	Propagation Delay	4.0	7.0	9.5	3.5	10.5	ns
t _{PHL}	SHCP to SO	4.5	8.0	10.5	4.0	12.0	
AC Operating Requirements							
Symbol	Parameter	T _A = +25°C V _{CC} = +5.0V		T _A = 0°C to +70°C V _{CC} = +5.0V		Units	
		Min	Max	Min	Max		
t _S (H)	Setup Time, HIGH or LOW	3.5		4.0		ns	
t _S (L)	CS or R/W to STCP	5.5		6.5			
t _H (H)	Hold Time, HIGH or LOW	0		0			
t _H (L)	CS or R/W to STCP	0		0		ns	
t _S (H)	Setup Time, HIGH or LOW	3.0		3.5			
t _S (L)	SI to SHCP	3.0		3.5			
t _H (H)	Hold Time, HIGH or LOW	3.0		3.5		ns	
t _H (L)	SI to SHCP	3.0		3.5			
t _S (H)	Setup Time, HIGH or LOW	6.5		7.5			
t _S (L)	R/W to SHCP	9.0		10.0		ns	
t _H (H)	Hold Time, HIGH or LOW	0		0			
t _H (L)	R/W to SHCP	0		0			
t _S (H)	Setup Time, HIGH or LOW	7.0		8.0		ns	
t _S (L)	STCP to SHCP	7.0		8.0			
t _H (H)	Hold Time, HIGH or LOW	0		0			
t _H (L)	STCP to SHCP	0		0		ns	
t _S (H)	Setup Time, HIGH or LOW	3.0		3.5			
t _S (L)	CS to SHCP	3.0		3.5			
t _H (H)	Hold Time, HIGH or LOW	3.0		3.5		ns	
t _H (L)	CS to SHCP	3.0		3.5			
t _W (H)	SHCP Pulse Width	5.0		6.0			
t _W (L)	HIGH or LOW	5.0		6.0		ns	
t _W (H)	STCP Pulse Width	6.0		7.0			
t _W (L)	HIGH or LOW	5.0		6.0			
t _S (L)	SHCP to STCP	8.0		9.0		ns	
t _H (H)	SHCP to STCP	0.0		0.0		ns	

Physical Dimensions inches (millimeters) unless otherwise noted

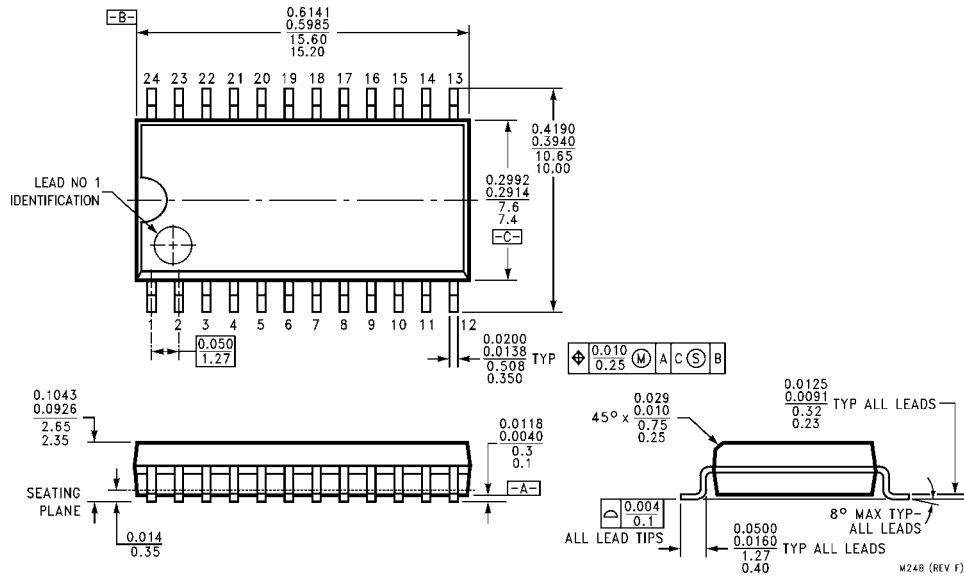

**24-Lead Small Outline Integrated Circuit (SOIC), JEDEC MS-013, 0.300 Wide
Package Number M24B**

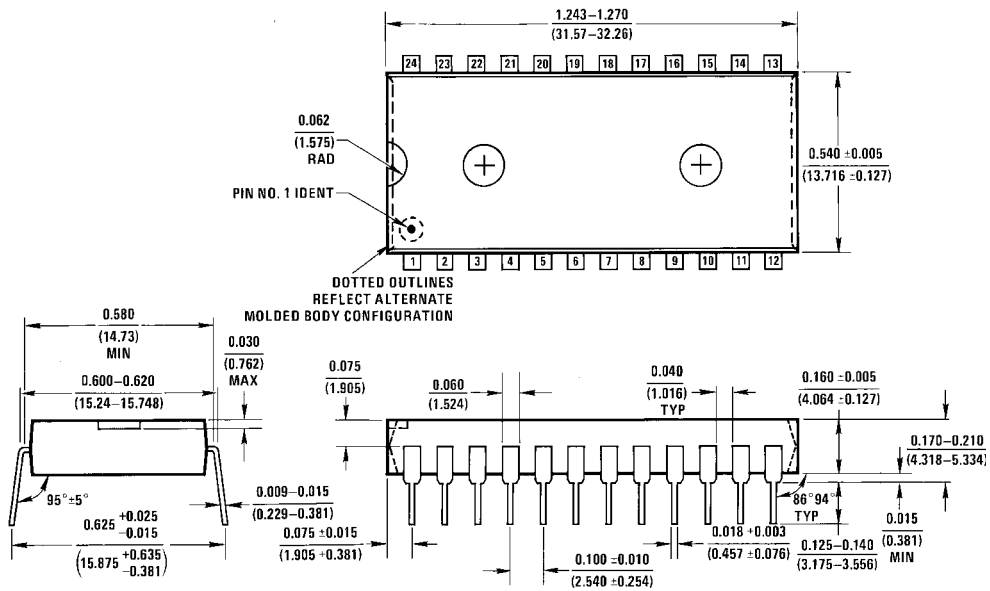

**24-Lead Plastic Dual-In-Line Package (PDIP), JEDEC MS-011, 0.600 Wide
Package Number N24A**

Physical Dimensions inches (millimeters) unless otherwise noted (Continued)

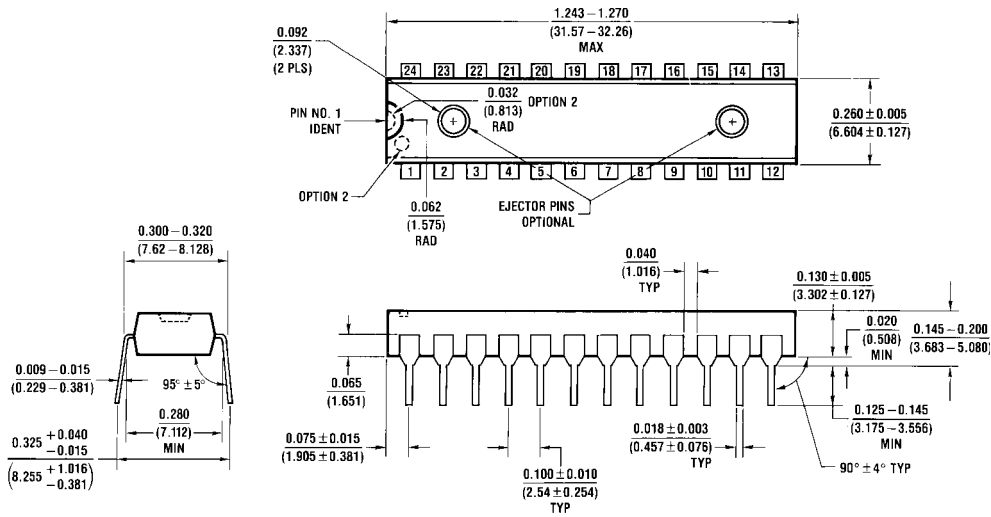

24-Lead Plastic Dual-In-Line Package (PDIP), JEDEC MS-001, 0.300 Wide Package Number N24C

N24C (REV F)

Fairchild does not assume any responsibility for use of any circuitry described, no circuit patent licenses are implied and Fairchild reserves the right at any time without notice to change said circuitry and specifications.

LIFE SUPPORT POLICY

FAIRCHILD'S PRODUCTS ARE NOT AUTHORIZED FOR USE AS CRITICAL COMPONENTS IN LIFE SUPPORT DEVICES OR SYSTEMS WITHOUT THE EXPRESS WRITTEN APPROVAL OF THE PRESIDENT OF FAIRCHILD SEMICONDUCTOR CORPORATION. As used herein:

1. Life support devices or systems are devices or systems which, (a) are intended for surgical implant into the body, or (b) support or sustain life, and (c) whose failure to perform when properly used in accordance with instructions for use provided in the labeling, can be reasonably expected to result in a significant injury to the user.
2. A critical component in any component of a life support device or system whose failure to perform can be reasonably expected to cause the failure of the life support device or system, or to affect its safety or effectiveness.

www.fairchildsemi.com



LittleDiode supplies new, hard to find or obsolete electronic components and semiconductors all over the world.

With over two million different components listed you are sure to find the part you need.

Feel free to visit us today at our online store:

LittleDiode.com

Looking forward to providing you with the best possible service.