

# DATA SHEET

For a complete data sheet, please also download:

- The IC06 74HC/HCT/HCU/HCMOS Logic Family Specifications
- The IC06 74HC/HCT/HCU/HCMOS Logic Package Information
- The IC06 74HC/HCT/HCU/HCMOS Logic Package Outlines

## **74HC/HCT14** Hex inverting Schmitt trigger

Product specification  
File under Integrated Circuits, IC06

September 1993

## Hex inverting Schmitt trigger

## 74HC/HCT14

## FEATURES

- Output capability: standard
- $I_{CC}$  category: SSI

## GENERAL DESCRIPTION

The 74HC/HCT14 are high-speed Si-gate CMOS devices and are pin compatible with low power Schottky TTL (LSTTL). They are specified in compliance with JEDEC standard no. 7A.

The 74HC/HCT14 provide six inverting buffers with Schmitt-trigger action. They are capable of transforming slowly changing input signals into sharply defined, jitter-free output signals.

## QUICK REFERENCE DATA

GND = 0 V;  $T_{amb} = 25\text{ }^{\circ}\text{C}$ ;  $t_r = t_f = 6\text{ ns}$

SYMBOL	PARAMETER	CONDITIONS	TYPICAL		UNIT
			HC	HCT	
$t_{PHL}/t_{PLH}$	propagation delay nA to nY	$C_L = 15\text{ pF}$ ; $V_{CC} = 5\text{ V}$	12	17	ns
$C_I$	input capacitance		3.5	3.5	pF
$C_{PD}$	power dissipation capacitance per gate	notes 1 and 2	7	8	pF

## Notes

1.  $C_{PD}$  is used to determine the dynamic power dissipation ( $P_D$  in  $\mu\text{W}$ ):

$$P_D = C_{PD} \times V_{CC}^2 \times f_i + \sum (C_L \times V_{CC}^2 \times f_o) \text{ where:}$$

$f_i$  = input frequency in MHz

$f_o$  = output frequency in MHz

$C_L$  = output load capacitance in pF

$V_{CC}$  = supply voltage in V

$\sum (C_L \times V_{CC}^2 \times f_o)$  = sum of outputs

2. For HC the condition is  $V_I = \text{GND to } V_{CC}$   
For HCT the condition is  $V_I = \text{GND to } V_{CC} - 1.5\text{ V}$

## ORDERING INFORMATION

See *"74HC/HCT/HCU/HCMOS Logic Package Information"*.

# Hex inverting Schmitt trigger

# 74HC/HCT14

## PIN DESCRIPTION

PIN NO.	SYMBOL	NAME AND FUNCTION
1, 3, 5, 9, 11, 13	1A to 6A	data inputs
2, 4, 6, 8, 10, 12	1Y to 6Y	data outputs
7	GND	ground (0 V)
14	V <sub>CC</sub>	positive supply voltage

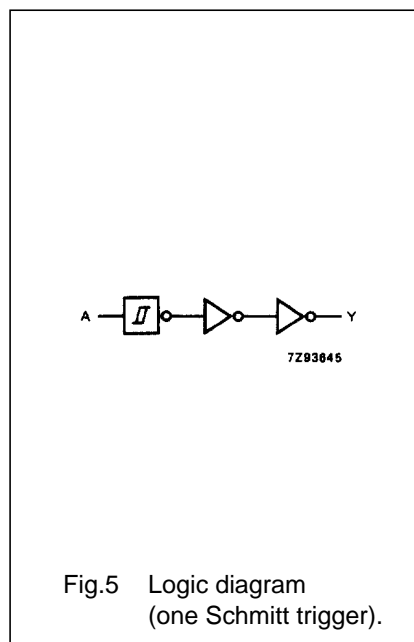
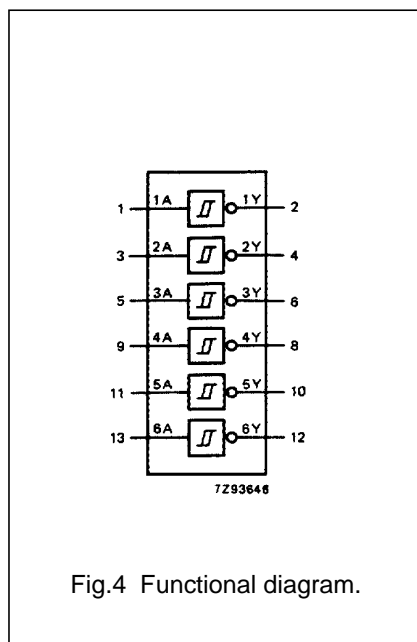
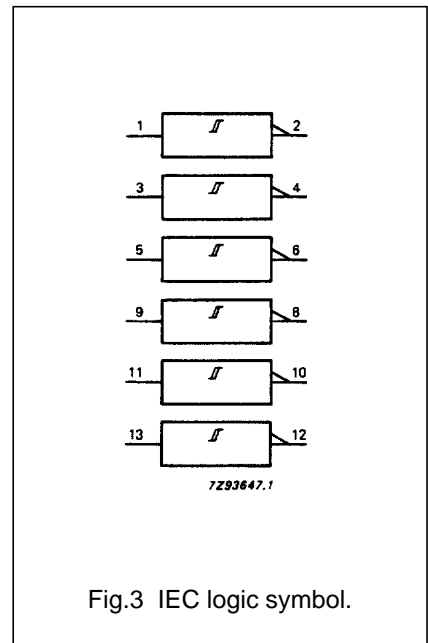
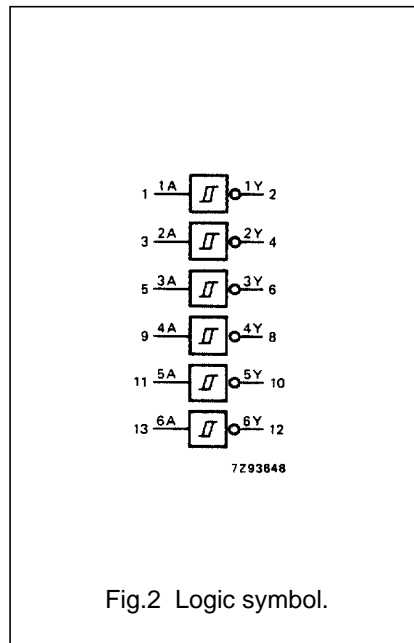
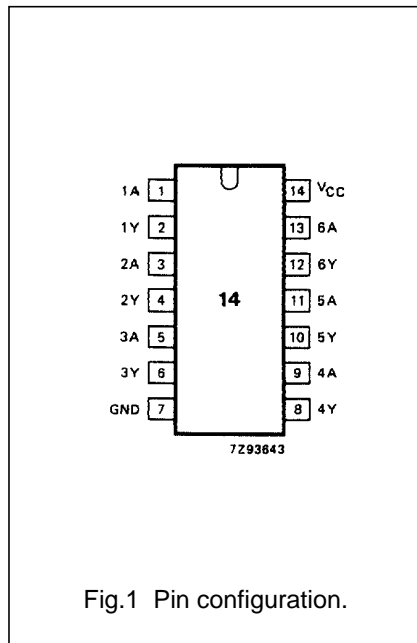

## FUNCTION TABLE

INPUT	OUTPUT
nA	nY
L	H
H	L

### Notes

- H = HIGH voltage level  
L = LOW voltage level

### APPLICATIONS

- Wave and pulse shapers
- Astable multivibrators
- Monostable multivibrators

## Hex inverting Schmitt trigger

## 74HC/HCT14

**DC CHARACTERISTICS FOR 74HC**

For the DC characteristics see *"74HC/HCT/HCU/HCMOS Logic Family Specifications"*. Transfer characteristics are given below.

Output capability: standard

I<sub>CC</sub> category: SSI

**Transfer characteristics for 74HC**

Voltages are referenced to GND (ground = 0 V)

SYMBOL	PARAMETER	T <sub>amb</sub> (°C)								UNIT	TEST CONDITIONS	
		74HC									V <sub>CC</sub> (V)	WAVEFORMS
		+25			-40 to +85		-40 to +125					
		min.	typ.	max.	min.	max.	min.	max.				
V <sub>T+</sub>	positive-going threshold	0.7 1.7 2.1	1.18 2.38 3.14	1.5 3.15 4.2	0.7 1.7 2.1	1.5 3.15 4.2	0.7 1.7 2.1	1.5 3.15 4.2	V	2.0 4.5 6.0	Figs 6 and 7	
V <sub>T-</sub>	negative-going threshold	0.3 0.9 1.2	0.52 1.40 1.89	0.90 2.00 2.60	0.3 0.90 1.20	0.90 2.00 2.60	0.30 0.90 1.2	0.90 2.00 2.60	V	2.0 4.5 6.0	Figs 6 and 7	
V <sub>H</sub>	hysteresis (V <sub>T+</sub> - V <sub>T-</sub> )	0.2 0.4 0.6	0.66 0.98 1.25	1.0 1.4 1.6	0.2 0.4 0.6	1.0 1.4 1.6	0.2 0.4 0.6	1.0 1.4 1.6	V	2.0 4.5 6.0	Figs 6 and 7	

**AC CHARACTERISTICS FOR 74HC**

GND = 0 V; t<sub>f</sub> = t<sub>r</sub> = 6 ns; C<sub>L</sub> = 50 pF

SYMBOL	PARAMETER	T <sub>amb</sub> (°C)								UNIT	TEST CONDITIONS	
		74HC									V <sub>CC</sub> (V)	WAVEFORMS
		+25			-40 to +85		-40 to +125					
		min.	typ.	max.	min.	max.	min.	max.				
t <sub>PHL</sub> / t <sub>PLH</sub>	propagation delay nA to nY		41 15 12	125 25 21		155 31 26		190 38 32	ns	2.0 4.5 6.0	Fig.8	
t <sub>THL</sub> / t <sub>TLH</sub>	output transition time		19 7 6	75 15 13		95 19 15		110 22 19	ns	2.0 4.5 6.0	Fig.8	

## Hex inverting Schmitt trigger

## 74HC/HCT14

**DC CHARACTERISTICS FOR 74HCT**

For the DC characteristics see *"74HC/HCT/HCU/HCMOS Logic Family Specifications"*. Transfer characteristics are given below.

Output capability: standard

$I_{CC}$  category: SSI

**Note to HCT types**

The value of additional quiescent supply current ( $\Delta I_{CC}$ ) for a unit load of 1 is given in the family specifications.

To determine  $\Delta I_{CC}$  per input, multiply this value by the unit load coefficient shown in the table below.

INPUT	UNIT LOAD COEFFICIENT
nA	0.3

**Transfer characteristics for 74HCT**

Voltages are referenced to GND (ground = 0 V)

SYMBOL	PARAMETER	$T_{amb}$ (°C)								UNIT	TEST CONDITIONS	
		74HCT									$V_{CC}$ (V)	WAVEFORMS
		+25			-40 to +85		-40 to +125					
		min.	typ.	max.	min.	max.	min.	max.				
$V_{T+}$	positive-going threshold	1.2	1.41	1.9	1.2	1.9	1.2	1.9	V	4.5 5.5	Figs 6 and 7	
$V_{T-}$	negative-going threshold	0.5	0.85	1.2	0.5	1.2	0.5	1.2	V	4.5 5.5	Figs 6 and 7	
$V_H$	hysteresis ( $V_{T+} - V_{T-}$ )	0.4	0.56	–	0.4	–	0.4	–	V	4.5 5.5	Figs 6 and 7	

**AC CHARACTERISTICS FOR 74HCT**

GND = 0 V;  $t_r = t_f = 6$  ns;  $C_L = 50$  pF

SYMBOL	PARAMETER	$T_{amb}$ (°C)								UNIT	TEST CONDITIONS	
		74HCT									$V_{CC}$ (V)	WAVEFORMS
		+25			-40 to +85		-40 to +125					
		min.	typ.	max.	min.	max.	min.	max.				
$t_{PHL} / t_{PLH}$	propagation delay nA, to nY		20	34		43		51	ns	4.5	Fig.8	
$t_{THL} / t_{TLH}$	output transition time		7	15		19		22	ns	4.5	Fig.8	

# Hex inverting Schmitt trigger

# 74HC/HCT14

## TRANSFER CHARACTERISTIC WAVEFORMS

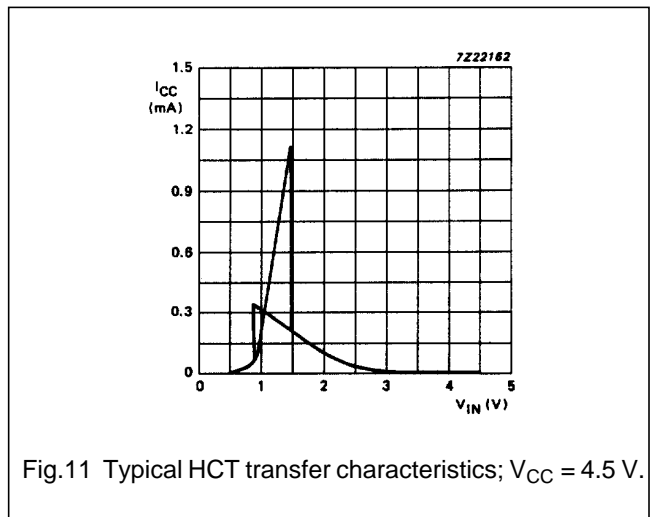
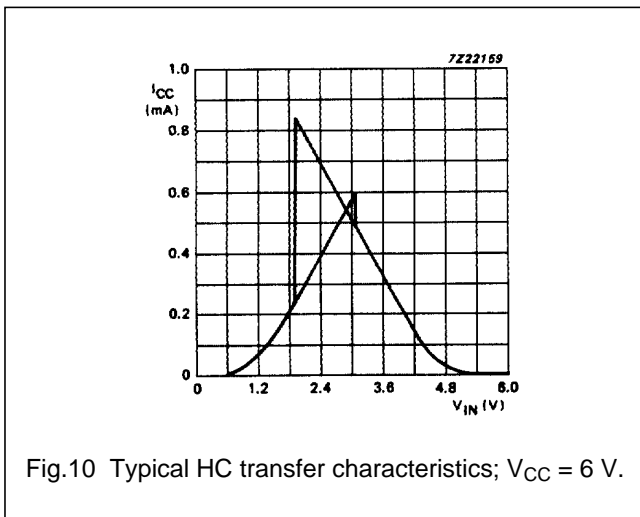
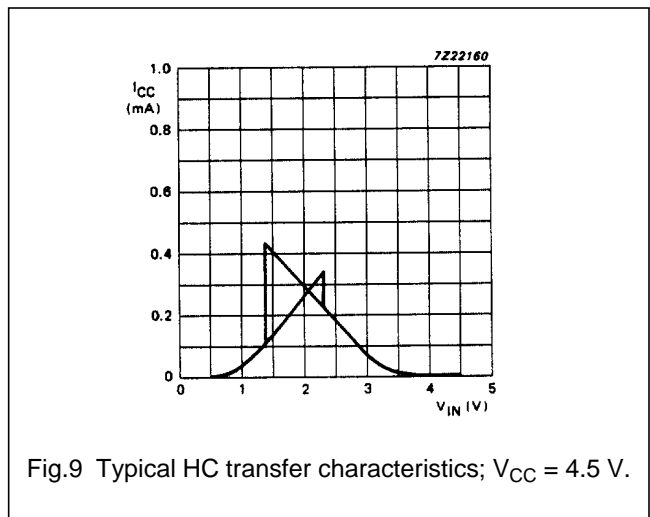
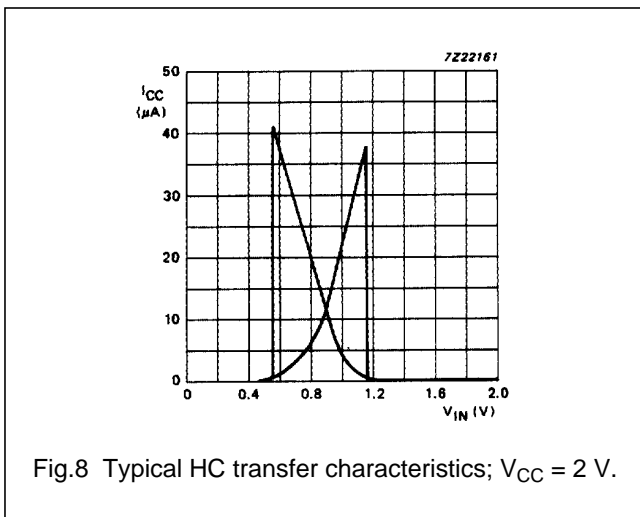
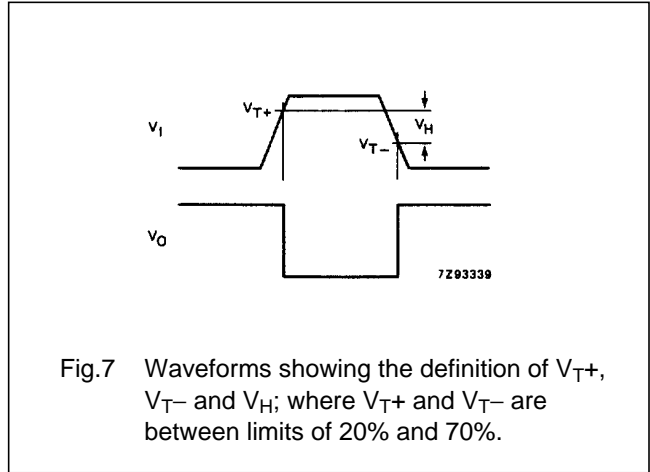
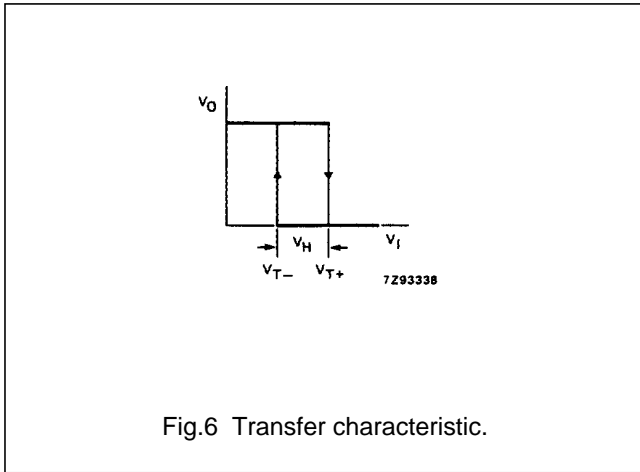

# Hex inverting Schmitt trigger

# 74HC/HCT14

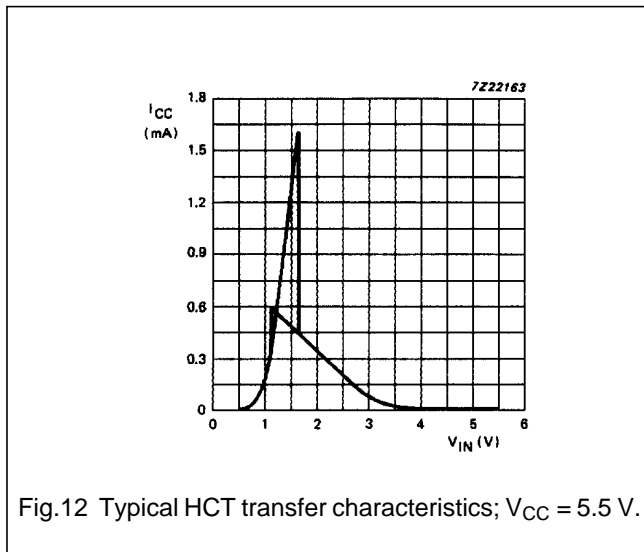
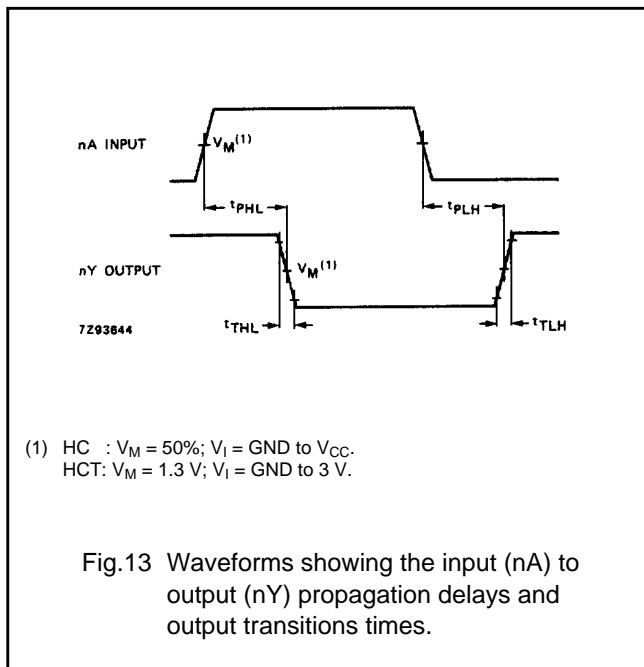

Fig.12 Typical HCT transfer characteristics;  $V_{CC} = 5.5 \text{ V}$ .

## AC WAVEFORMS



# Hex inverting Schmitt trigger

# 74HC/HCT14

## APPLICATION INFORMATION

The slow input rise and fall times cause additional power dissipation, this can be calculated using the following formula:

$$P_{ad} = f_i \times (t_r \times I_{CCa} + t_f \times I_{CCa}) \times V_{CC}$$

Where:

- $P_{ad}$  = additional power dissipation ( $\mu W$ )
- $f_i$  = input frequency (MHz)
- $t_r$  = input rise time ( $\mu s$ ); 10% – 90%
- $t_f$  = input fall time ( $\mu s$ ); 10% – 90%
- $I_{CCa}$  = average additional supply current ( $\mu A$ )

Average  $I_{CCa}$  differs with positive or negative input transitions, as shown in Figs 14 and 15.

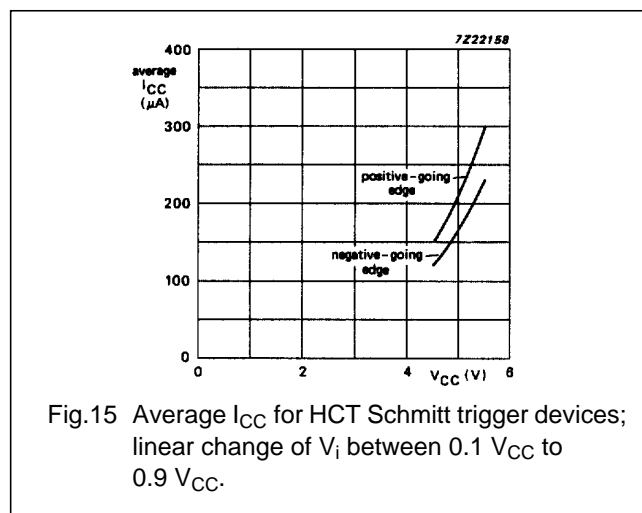
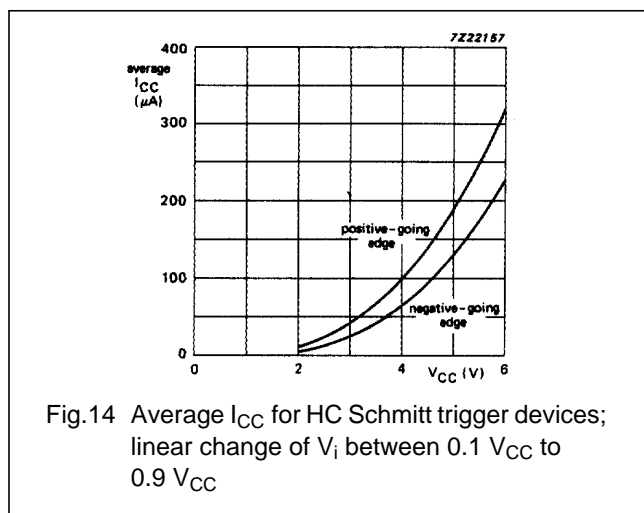

HC/HCT14 used in a relaxation oscillator circuit, see Fig.16.

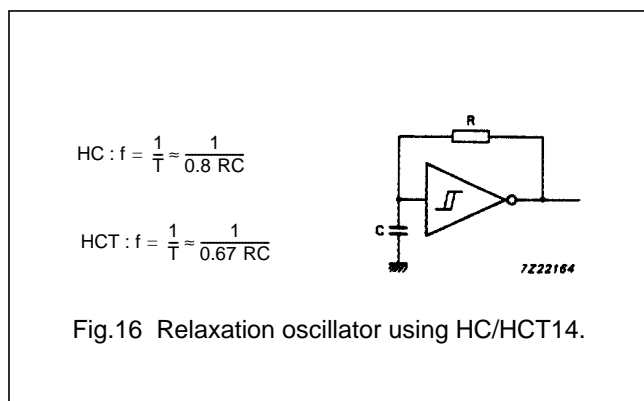

### Note to Application information

All values given are typical unless otherwise specified.

### PACKAGE OUTLINES

See *"74HC/HCT/HCU/HCMOS Logic Package Outlines"*.



LittleDiode supplies new, hard to find or obsolete electronic components and semiconductors all over the world.

With over two million different components listed you are sure to find the part you need.

Feel free to visit us today at our online store:

[LittleDiode.com](http://LittleDiode.com)

Looking forward to providing you with the best possible service.