

# DATA SHEET

For a complete data sheet, please also download:

- The IC06 74HC/HCT/HCU/HCMOS Logic Family Specifications
- The IC06 74HC/HCT/HCU/HCMOS Logic Package Information
- The IC06 74HC/HCT/HCU/HCMOS Logic Package Outlines

## **74HC/HCT157** Quad 2-input multiplexer

Product specification  
File under Integrated Circuits, IC06

December 1990

## Quad 2-input multiplexer

## 74HC/HCT157

## FEATURES

- Non-inverting data path
- Output capability: standard
- I<sub>CC</sub> category: MSI

## GENERAL DESCRIPTION

The 74HC/HCT157 are high-speed Si-gate CMOS devices and are pin compatible with low power Schottky TTL (LSTTL). They are specified in compliance with JEDEC standard no. 7A.

The 74HC/HCT157 are quad 2-input multiplexers which select 4 bits of data from two sources under the control of a common data select input (S). The four outputs present the selected data in the true (non-inverted) form. The enable input ( $\bar{E}$ ) is active LOW. When  $\bar{E}$  is HIGH, all of the outputs (1Y to 4Y) are forced LOW regardless of all other input conditions.

Moving the data from two groups of registers to four common output buses is a common use of the "157". The state of the common data select input (S) determines the particular register from which the data comes. It can also be used as function generator.

The device is useful for implementing highly irregular logic by generating any four of the 16 different functions of two variables with one variable common.

The "157" is the logic implementation of a 4-pole, 2-position switch, where the position of the switch is determined by the logic levels applied to S.

The logic equations are:

$$1Y = \bar{E} \cdot (1I_1 \cdot S + 1I_0 \cdot \bar{S})$$

$$2Y = \bar{E} \cdot (2I_1 \cdot S + 2I_0 \cdot \bar{S})$$

$$3Y = \bar{E} \cdot (3I_1 \cdot S + 3I_0 \cdot \bar{S})$$

$$4Y = \bar{E} \cdot (4I_1 \cdot S + 4I_0 \cdot \bar{S})$$

The "157" is identical to the "158" but has non-inverting (true) outputs.

## QUICK REFERENCE DATA

GND = 0 V; T<sub>amb</sub> = 25 °C; t<sub>r</sub> = t<sub>f</sub> = 6 ns

SYMBOL	PARAMETER	CONDITIONS	TYPICAL		UNIT
			HC	HCT	
t <sub>PHL</sub> / t <sub>PLH</sub>	propagation delay	C <sub>L</sub> = 15 pF; V <sub>CC</sub> = 5 V			
	nI <sub>0</sub> , nI <sub>1</sub> to nY		11	13	ns
	$\bar{E}$ to nY		11	12	ns
	S to nY		12	19	ns
C <sub>I</sub>	input capacitance		3.5	3.5	pF
C <sub>PD</sub>	power dissipation capacitance per multiplexer	notes 1 and 2	70	70	pF

## Notes

1. C<sub>PD</sub> is used to determine the dynamic power dissipation (P<sub>D</sub> in μW):

$$P_D = C_{PD} \times V_{CC}^2 \times f_i + \sum (C_L \times V_{CC}^2 \times f_o) \text{ where:}$$

f<sub>i</sub> = input frequency in MHz

f<sub>o</sub> = output frequency in MHz

∑ (C<sub>L</sub> × V<sub>CC</sub><sup>2</sup> × f<sub>o</sub>) = sum of outputs

C<sub>L</sub> = output load capacitance in pF

V<sub>CC</sub> = supply voltage in V

2. For HC the condition is V<sub>I</sub> = GND to V<sub>CC</sub>  
For HCT the condition is V<sub>I</sub> = GND to V<sub>CC</sub> – 1.5 V

## ORDERING INFORMATION

See "74HC/HCT/HCU/HCMOS Logic Package Information".

# Quad 2-input multiplexer

# 74HC/HCT157

## PIN DESCRIPTION

PIN NO.	SYMBOL	NAME AND FUNCTION
1	S	common data select input
2, 5, 11, 14	1I <sub>0</sub> to 4I <sub>0</sub>	data inputs from source 0
3, 6, 10, 13	1I <sub>1</sub> to 4I <sub>1</sub>	data inputs from source 1
4, 7, 9, 12	1Y to 4Y	multiplexer outputs
8	GND	ground (0 V)
15	$\bar{E}$	enable input (active LOW)
16	V <sub>CC</sub>	positive supply voltage

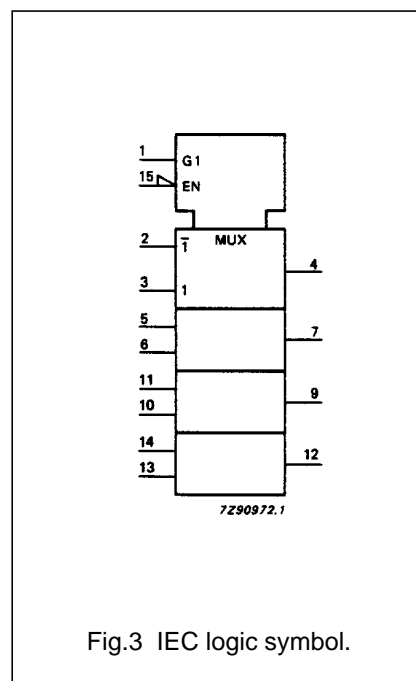
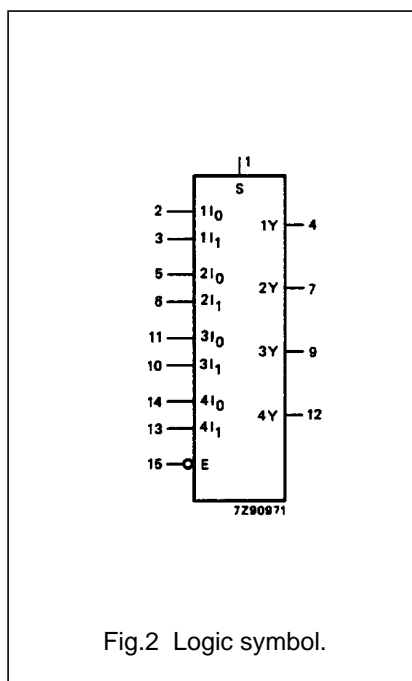
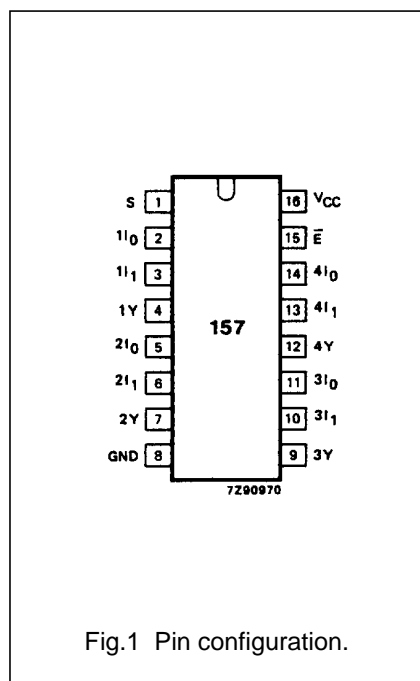

Quad 2-input multiplexer

74HC/HCT157

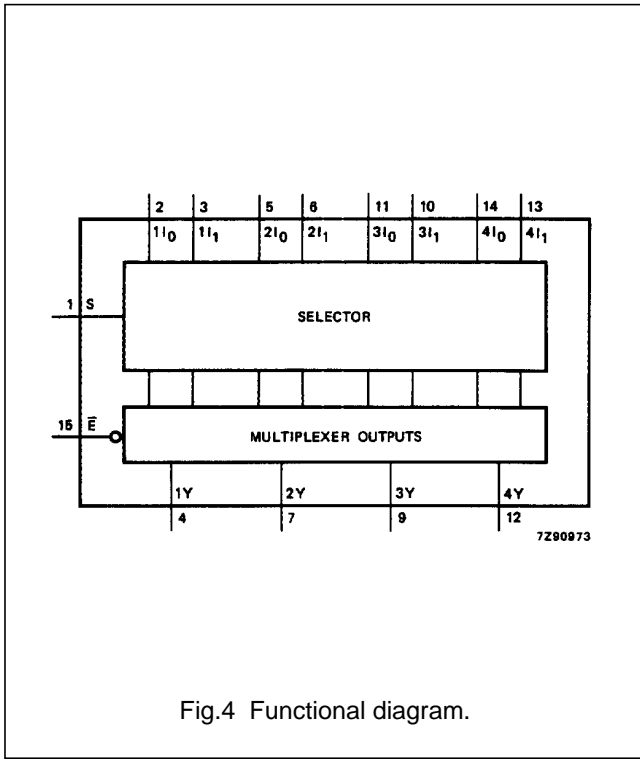

Fig.4 Functional diagram.

FUNCTION TABLE

INPUTS				OUTPUT
$\bar{E}$	S	$nI_0$	$nI_1$	$nY$
H	X	X	X	L
L	L	L	X	L
L	L	H	X	H
L	H	X	L	L
L	H	X	H	H

Notes

1. H = HIGH voltage level  
L = LOW voltage level  
X = don't care

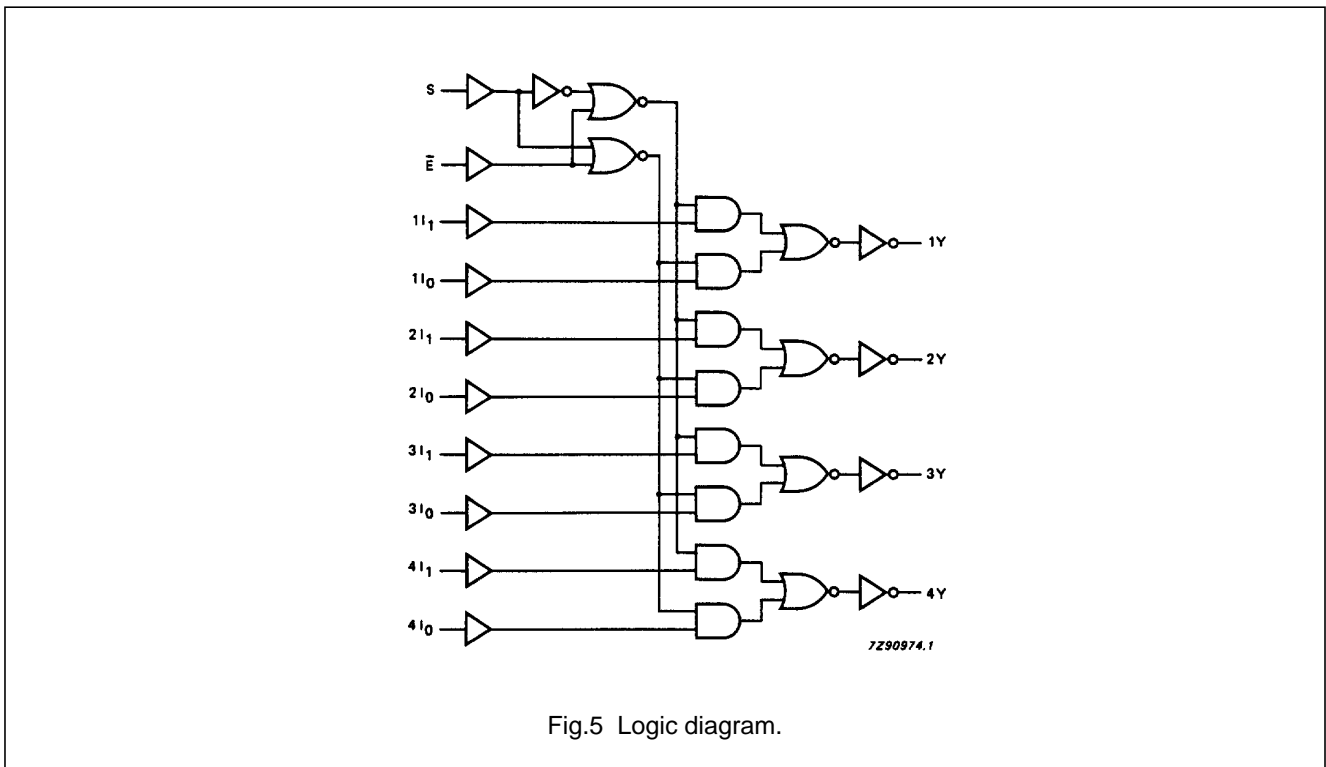

Fig.5 Logic diagram.

## Quad 2-input multiplexer

## 74HC/HCT157

**DC CHARACTERISTICS FOR 74HC**

For the DC characteristics see *"74HC/HCT/HCU/HCMOS Logic Family Specifications"*.

Output capability: standard

I<sub>CC</sub> category: MSI

**AC CHARACTERISTICS FOR 74HC**

GND = 0 V; t<sub>r</sub> = t<sub>f</sub> = 6 ns; C<sub>L</sub> = 50 pF

SYMBOL	PARAMETER	T <sub>amb</sub> (°C)						UNIT	TEST CONDITIONS		
		74HC							V <sub>CC</sub> (V)	WAVEFORMS	
		+25			-40 to +85		-40 to +125				
		min.	typ.	max.	min.	max.	min.				max.
t <sub>PHL</sub> / t <sub>PLH</sub>	propagation delay nI <sub>0</sub> to nY; nI <sub>1</sub> to nY		36 13 10	125 25 21		155 31 26		190 38 32	ns	2.0 4.5 6.0	Fig.7
t <sub>PHL</sub> / t <sub>PLH</sub>	propagation delay $\bar{E}$ to nY		39 14 11	115 23 20		145 29 25		175 35 30	ns	2.0 4.5 6.0	Fig.6
t <sub>PHL</sub> / t <sub>PLH</sub>	propagation delay S to nY		41 15 12	125 25 21		155 31 26		190 38 32	ns	2.0 4.5 6.0	Fig.7
t <sub>THL</sub> / t <sub>TLH</sub>	output transition time		19 7 6	75 15 13		95 19 16		110 22 19	ns	2.0 4.5 6.0	Fig.6 and Fig.7

## Quad 2-input multiplexer

## 74HC/HCT157

**DC CHARACTERISTICS FOR 74HCT**

For the DC characteristics see *"74HC/HCT/HCU/HCMOS Logic Family Specifications"*.

Output capability: standard

I<sub>CC</sub> category: MSI

**Note to HCT types**

The value of additional quiescent supply current ( $\Delta I_{CC}$ ) for a unit load of 1 is given in the family specifications. To determine  $\Delta I_{CC}$  per input, multiply this value by the unit load coefficient shown in the table below.

INPUT	UNIT LOAD COEFFICIENT
nI <sub>0</sub>	1.00
nI <sub>1</sub>	1.00
$\bar{E}$	0.60
S	1.00

**AC CHARACTERISTICS FOR 74HCT**

GND = 0 V; t<sub>r</sub> = t<sub>f</sub> = 6 ns; C<sub>L</sub> = 50 pF

SYMBOL	PARAMETER	T <sub>amb</sub> (°C)								UNIT	TEST CONDITIONS	
		74HCT									V <sub>CC</sub> (V)	WAVEFORMS
		+25			-40 to +85		-40 to +125					
		min.	typ.	max.	min.	max.	min.	max.				
t <sub>PHL</sub> / t <sub>PLH</sub>	propagation delay nI <sub>0</sub> to nY; nI <sub>1</sub> to nY		16	27		34		41	ns	4.5	Fig.7	
t <sub>PHL</sub> / t <sub>PLH</sub>	propagation delay $\bar{E}$ to nY		15	26		33		39	ns	4.5	Fig.6	
t <sub>PHL</sub> / t <sub>PLH</sub>	propagation delay S to nY		22	37		46		56	ns	4.5	Fig.7	
t <sub>THL</sub> / t <sub>TLH</sub>	output transition time		7	15		19		22	ns	4.5	Fig.6 and Fig.7	

## Quad 2-input multiplexer

74HC/HCT157

## AC WAVEFORMS

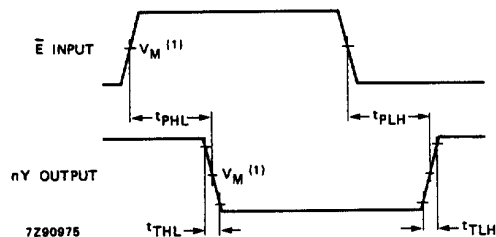

(1) HC :  $V_M = 50\%$ ;  $V_I = \text{GND to } V_{CC}$ .  
 HCT:  $V_M = 1.3 \text{ V}$ ;  $V_I = \text{GND to } 3 \text{ V}$ .

Fig.6 Waveforms showing the enable input ( $\bar{E}$ ) to output ( $nY$ ) propagation delays and the output transition times.

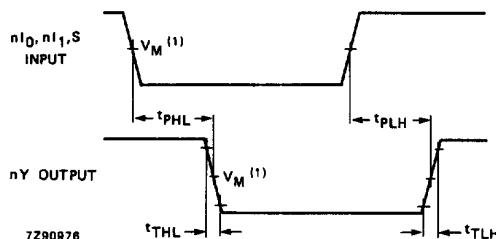

(1) HC :  $V_M = 50\%$ ;  $V_I = \text{GND to } V_{CC}$ .  
 HCT:  $V_M = 1.3 \text{ V}$ ;  $V_I = \text{GND to } 3 \text{ V}$ .

Fig.7 Waveforms showing the data inputs ( $nI_n$ ) and common data select input (S) to output ( $nY$ ) propagation delays.

## PACKAGE OUTLINES

See "74HC/HCT/HCU/HCMOS Logic Package Outlines".



LittleDiode supplies new, hard to find or obsolete electronic components and semiconductors all over the world.

With over two million different components listed you are sure to find the part you need.

Feel free to visit us today at our online store:

[LittleDiode.com](http://LittleDiode.com)

Looking forward to providing you with the best possible service.