

### Features

- High speed switching
- Low on-resistance
- No secondary breakdown
- Low driving power
- Avalanche-proof

### Applications

- Switching regulators
- UPS (Uninterruptible Power Supply)
- DC-DC converters

### Maximum ratings and characteristic Absolute maximum ratings

(Tc=25°C unless otherwise specified)

Item	Symbol	Ratings	Unit
Drain-source voltage	V <sub>DS</sub>	500	V
Continuous drain current	I <sub>D</sub>	±8	A
Pulsed drain current	I <sub>D(puls)</sub>	±32	A
Gate-source voltage	V <sub>GS</sub>	±30	V
Repetitive or non-repetitive	IAR *2	8	A
Maximum Avalanche Energy	EAS *1	173	mJ
Maximum Drain-Source dV/dt	dV <sub>DS</sub> /dt *4	20	kV/μs
Peak Diode Recovery dV/dt	dV/dt *3	5	kV/μs
Max. power dissipation	P <sub>D</sub>	T <sub>a</sub> =25°C	2.02
		T <sub>c</sub> =25°C	65
Operating and storage temperature range	T <sub>ch</sub>	+150	°C
	T <sub>stg</sub>	-55 to +150	°C

\*1 L=4.98mH, V<sub>CC</sub>=50V \*2 T<sub>ch</sub>≤150°C \*3 I<sub>F</sub>≤-I<sub>D</sub>, -di/dt=50A/μs, V<sub>CC</sub>≤BV<sub>DS</sub>, T<sub>ch</sub>≤150°C  
 \*4 V<sub>DS</sub>≤500V

### Electrical characteristics (T<sub>c</sub> =25°C unless otherwise specified)

Item	Symbol	Test Conditions	Min.	Typ.	Max.	Units
Drain-source breakdown voltage	V <sub>(BR)DSS</sub>	I <sub>D</sub> =250μA V <sub>GS</sub> =0V	500			V
Gate threshold voltage	V <sub>GS(th)</sub>	I <sub>D</sub> =250μA V <sub>DS</sub> =V <sub>GS</sub>	3.0		5.0	V
Zero gate voltage drain current	I <sub>DSS</sub>	V <sub>DS</sub> =500V V <sub>GS</sub> =0V			25	μA
		V <sub>DS</sub> =400V V <sub>GS</sub> =0V			250	
Gate-source leakage current	I <sub>GSS</sub>	V <sub>GS</sub> =±30V V <sub>DS</sub> =0V		10	100	nA
Drain-source on-state resistance	R <sub>DS(on)</sub>	I <sub>D</sub> =4A V <sub>GS</sub> =10V		0.65	0.85	Ω
Forward transconductance	g <sub>fs</sub>	I <sub>D</sub> =4A V <sub>DS</sub> =25V	3.5	7		S
Input capacitance	C <sub>iss</sub>	V <sub>DS</sub> =25V		750	1130	pF
Output capacitance	C <sub>oss</sub>	V <sub>GS</sub> =0V		100	150	
Reverse transfer capacitance	C <sub>rss</sub>	f=1MHz		4.0	6.0	
Turn-on time t <sub>on</sub>	td(on)	V <sub>CC</sub> =300V I <sub>D</sub> =4A		14	21	ns
	t <sub>r</sub>	V <sub>GS</sub> =10V		9	14	
Turn-off time t <sub>off</sub>	td(off)	R <sub>GS</sub> =10 Ω		24	36	
	t <sub>f</sub>			6	9	
Total Gate Charge	Q <sub>G</sub>	V <sub>CC</sub> =250V		20	30	nC
Gate-Source Charge	Q <sub>GS</sub>	I <sub>D</sub> =8A		8.5	13	
Gate-Drain Charge	Q <sub>GD</sub>	V <sub>GS</sub> =10V		5.5	8.5	
Avalanche capability	I <sub>AV</sub>	L=4.98mH T <sub>ch</sub> =25°C	8			A
Diode forward on-voltage	V <sub>SD</sub>	I <sub>F</sub> =8A V <sub>GS</sub> =0V T <sub>ch</sub> =25°C		1.00	1.50	V
Reverse recovery time	t <sub>rr</sub>	I <sub>F</sub> =8A V <sub>GS</sub> =0V		0.65		μs
Reverse recovery charge	Q <sub>rr</sub>	-di/dt=100A/μs T <sub>ch</sub> =25°C		3.5		μC

### Thermal characteristics

Item	Symbol	Test Conditions	Min.	Typ.	Max.	Units
Thermal resistance	R <sub>th(ch-c)</sub>	channel to case			1.92	°C/W
	R <sub>th(ch-a)</sub>	channel to ambient			62.0	°C/W

### Outline Drawings

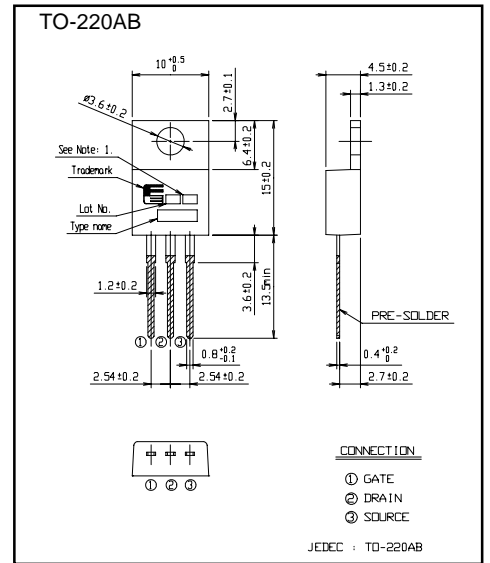

### Equivalent circuit schematic

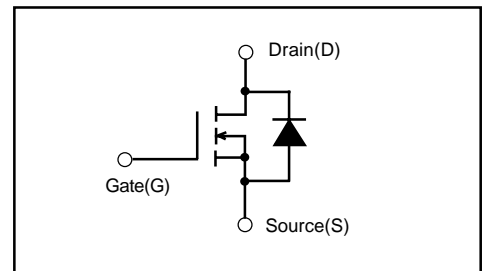

Characteristics

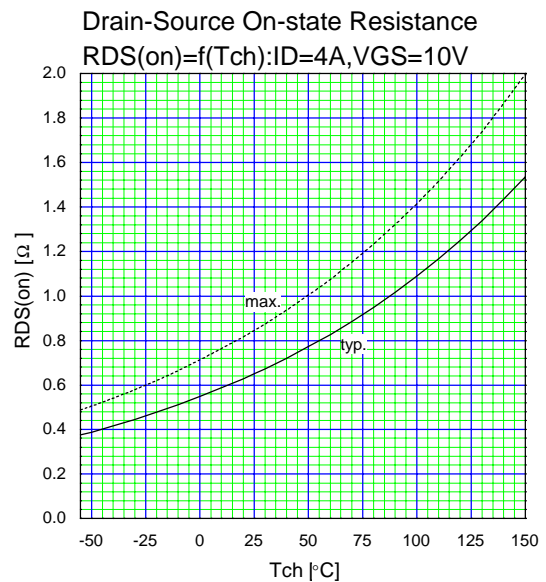
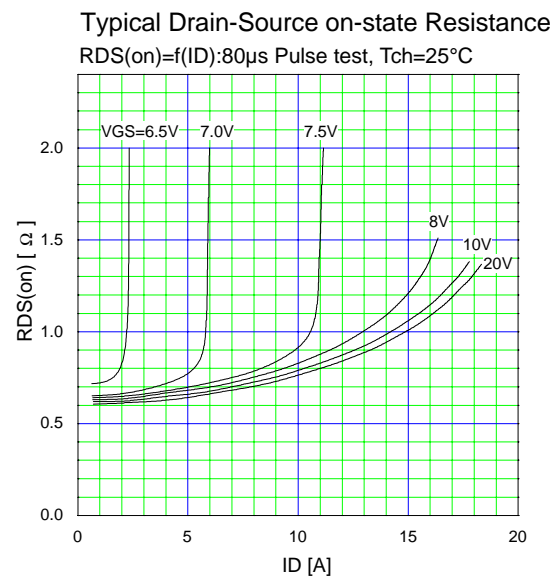
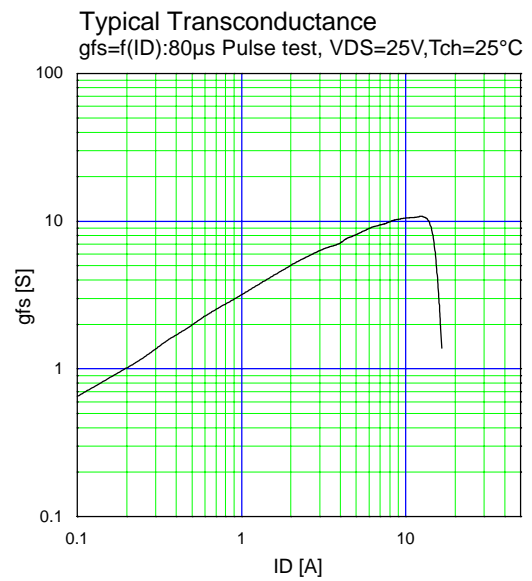
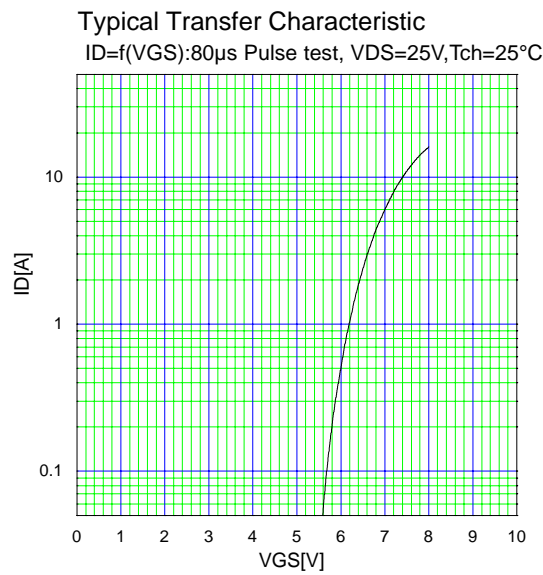
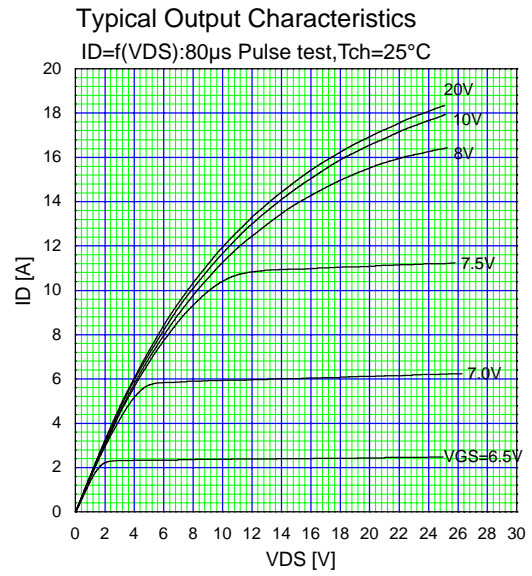
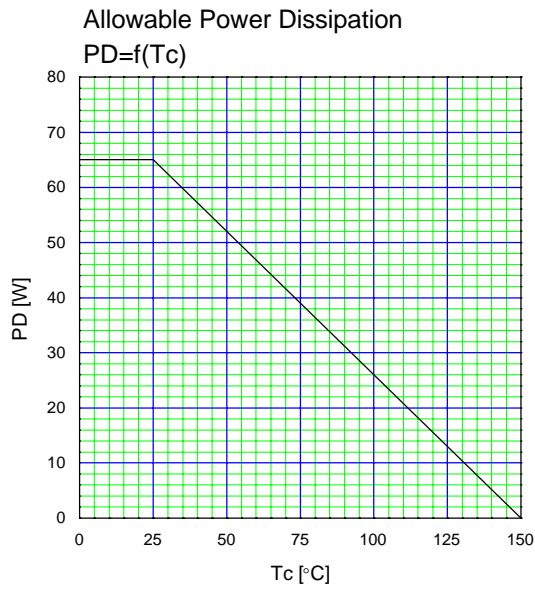

Gate Threshold Voltage vs. T<sub>ch</sub>  
 $V_{GS(th)}=f(T_{ch}):V_{DS}=V_{GS}, I_D=1\text{mA}$

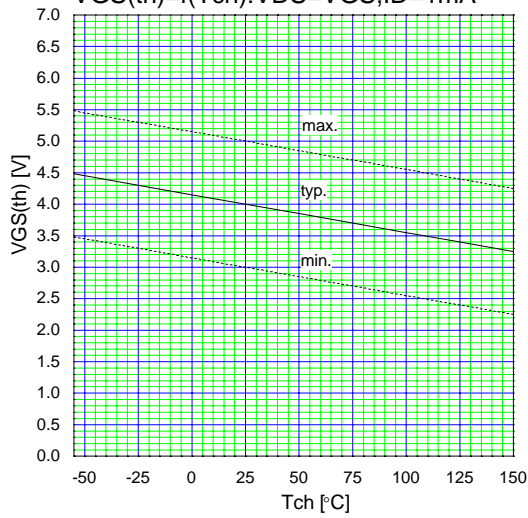

Typical Gate Charge Characteristics  
 $V_{GS}=f(Q_g):I_D=8\text{A}, T_{ch}=25^\circ\text{C}$

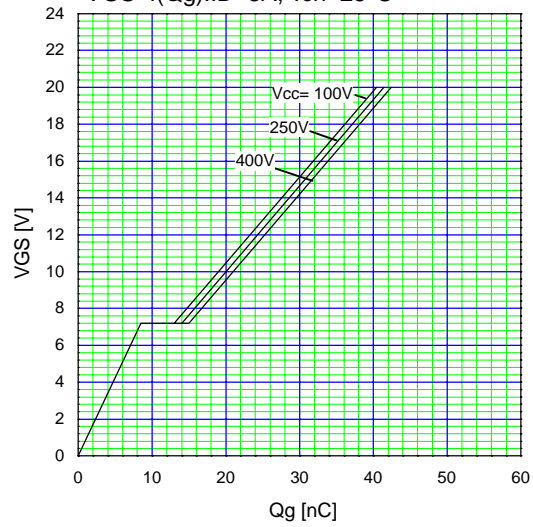

Typical Capacitance  
 $C=f(V_{DS}):V_{GS}=0\text{V}, f=1\text{MHz}$

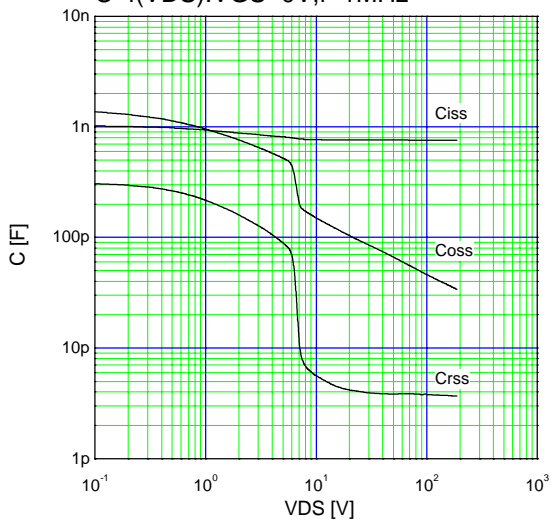

Typical Forward Characteristics of Reverse Diode  
 $I_F=f(V_{SD}):80\mu\text{s Pulse test}, T_{ch}=25^\circ\text{C}$

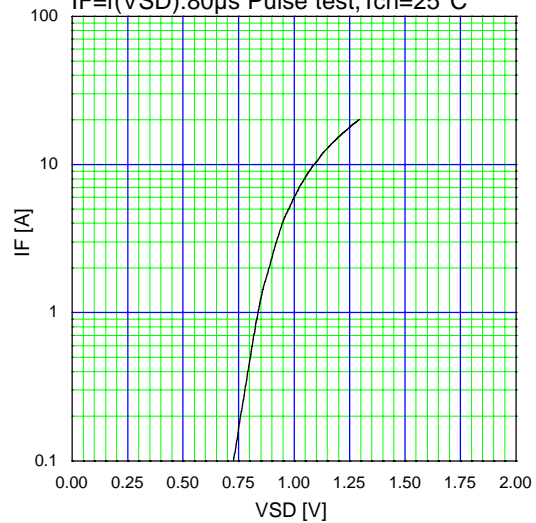

Typical Switching Characteristics vs. I<sub>D</sub>  
 $t=f(I_D):V_{cc}=300\text{V}, V_{GS}=10\text{V}, R_G=10\Omega$

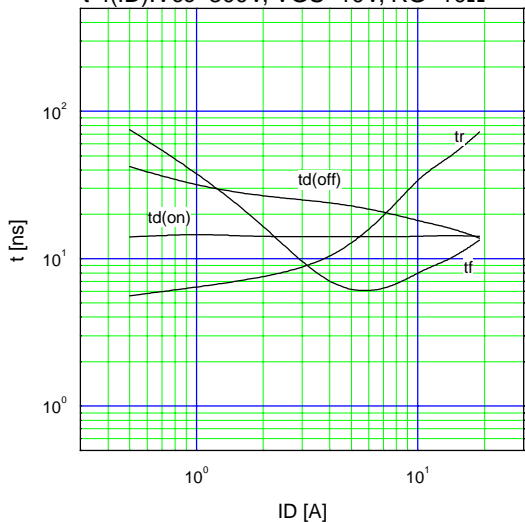

Maximum Avalanche Energy vs. starting T<sub>ch</sub>  
 $E(AV)=f(\text{starting } T_{ch}):V_{cc}=50\text{V}, I(AV)\leq 8\text{A}$

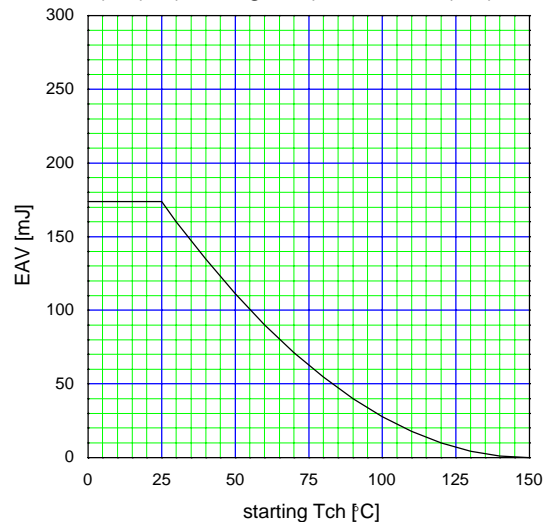

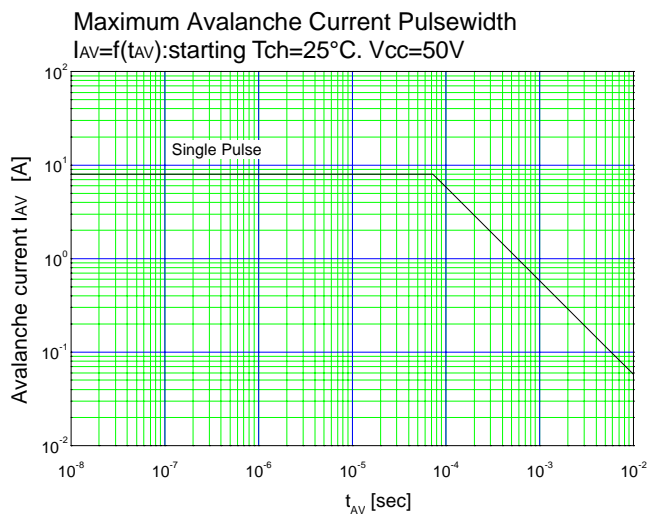
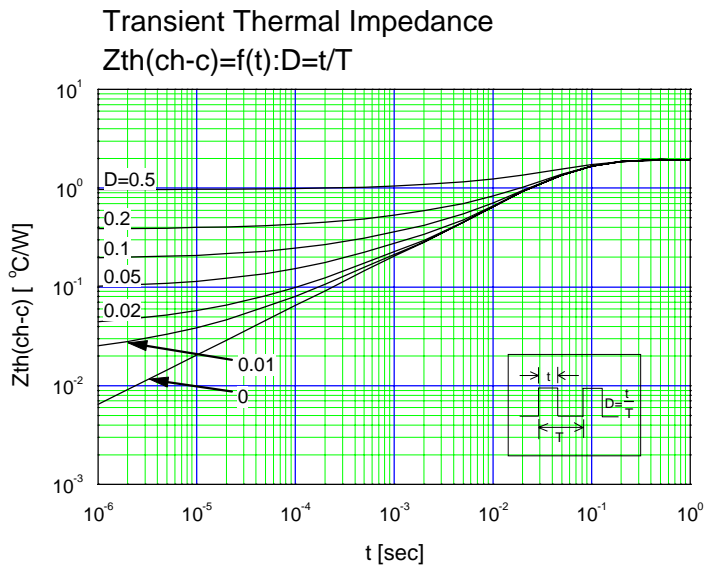

This datasheet has been downloaded from:

[www.DatasheetCatalog.com](http://www.DatasheetCatalog.com)

Datasheets for electronic components.



LittleDiode supplies new, hard to find or obsolete electronic components and semiconductors all over the world.

With over two million different components listed you are sure to find the part you need.

Feel free to visit us today at our online store:

**[LittleDiode.com](http://LittleDiode.com)**

Looking forward to providing you with the best possible service.