

> Features

- High Current
- Low On-Resistance
- No Secondary Breakdown
- Low Driving Power
- Avalanche Rated

> Applications

- Motor Control
- General Purpose Power Amplifier
- DC-DC converters

> Outline Drawing

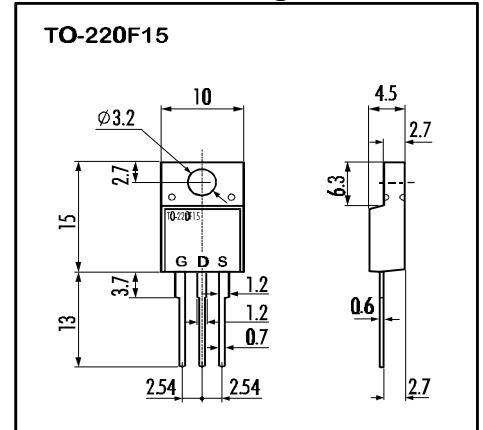

> Maximum Ratings and Characteristics

- Absolute Maximum Ratings (T_C=25°C), unless otherwise specified

Item	Symbol	Rating	Unit
Drain-Source-Voltage	V _{DS}	60	V
Continous Drain Current	I _D	50	A
Pulsed Drain Current	I _{D(puls)}	200	A
Gate-Source-Voltage	V _{GS}	±20	V
Maximum Avalanche Energy	E _{AV}	453	mJ*
Max. Power Dissipation	P _D	50	W
Operating and Storage Temperature Range	T _{ch}	150	°C
	T _{stg}	-55 ~ +150	°C

* L=0,241mH, V_{CC}=24V

> Equivalent Circuit

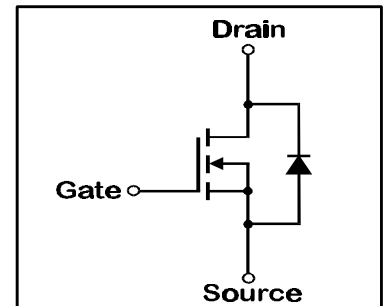

- Electrical Characteristics (T_C=25°C), unless otherwise specified

Item	Symbol	Test conditions	Min.	Typ.	Max.	Unit
Drain-Source Breakdown-Voltage	V _{(BR)DSS}	I _D =1mA V _{GS} =0V	60			V
Gate Threshold Voltage	V _{GS(th)}	I _D =1mA V _{DS} =V _{GS}	1,0	1,5	2,0	V
Zero Gate Voltage Drain Current	I _{DSS}	V _{DS} =60V T _{ch} =25°C		10	500	μA
		V _{GS} =0V T _{ch} =125°C		0,2	1,0	mA
Gate Source Leakage Current	I _{GSS}	V _{GS} =±20V V _{DS} =0V		10	100	nA
Drain Source On-State Resistance	R _{DS(on)}	I _D =40A V _{GS} =4V		0,012	0,017	Ω
		I _D =40A V _{GS} =10V		0,0075	0,01	Ω
Forward Transconductance	g _{fs}	I _D =40A V _{DS} =25V	25	55		S
Input Capacitance	C _{iss}	V _{DS} =25V		3500	5250	pF
Output Capacitance	C _{oss}	V _{GS} =0V		1250	1870	pF
Reverse Transfer Capacitance	C _{rss}	f=1MHz		360	540	pF
Turn-On-Time t _{on} (t _{on} =t _{d(on)} +t _r)	t _{d(on)}	V _{CC} =30V		15	23	ns
		I _D =75A		75	120	ns
Turn-Off-Time t _{off} (t _{off} =t _{d(off)} +t _f)	t _{d(off)}	V _{GS} =10V		190	285	ns
		R _{GS} =10 Ω		110	165	ns
Avalanche Capability	I _{AV}	L = 100μH T _{ch} =25°C	50			A
Diode Forward On-Voltage	V _{SD}	I _F =160A V _{GS} =0V T _{ch} =25°C		1,15	1,65	V
Reverse Recovery Time	t _{rr}	I _F =80A V _{GS} =0V		75	120	ns
Reverse Recovery Charge	Q _{rr}	-di _F /dt=100A/μs T _{ch} =25°C		0,17		μC

- Thermal Characteristics

Item	Symbol	Test conditions	Min.	Typ.	Max.	Unit
Thermal Resistance	R _{th(ch-a)}	channel to air			62,5	°C/W
	R _{th(ch-c)}	channel to case			2,50	°C/W

> Characteristics

Typical Output Characteristics

$I_D=f(V_{DS})$; 80μs pulse test; $T_C=25^\circ\text{C}$

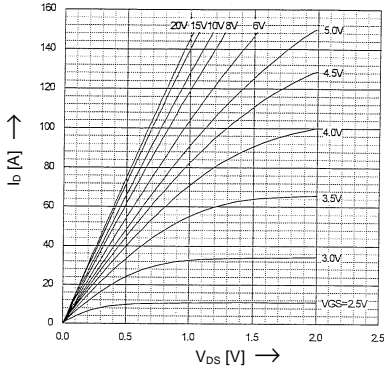

Drain-Source On-State Resistance vs. T_{ch}

$R_{DS(on)}=f(T_{ch})$; $I_D=40\text{A}$; $V_{GS}=10\text{V}$

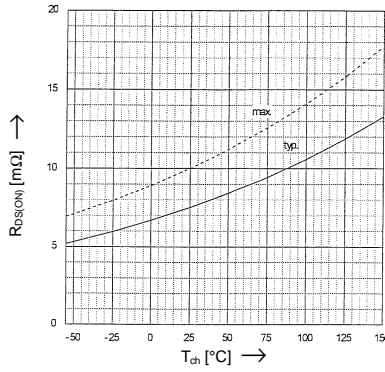

Typical Transfer Characteristics

$I_D=f(V_{GS})$; 80μs pulse test; $V_{DS}=25\text{V}$; $T_{ch}=25^\circ\text{C}$

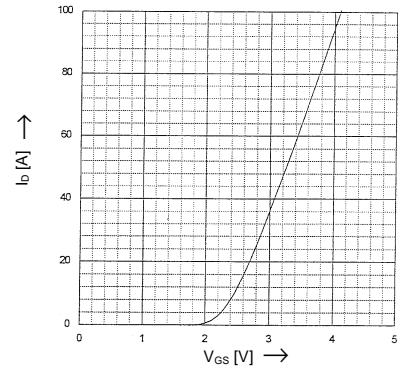

Typical Drain-Source On-State-Resistance vs. I_D

$R_{DS(on)}=f(I_D)$; 80μs pulse test; $T_C=25^\circ\text{C}$

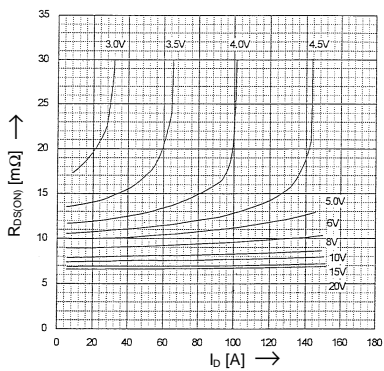

Typical Forward Transconductance vs. I_D

$g_{fs}=f(I_D)$; 80μs pulse test; $V_{DS}=25\text{V}$; $T_{ch}=25^\circ\text{C}$

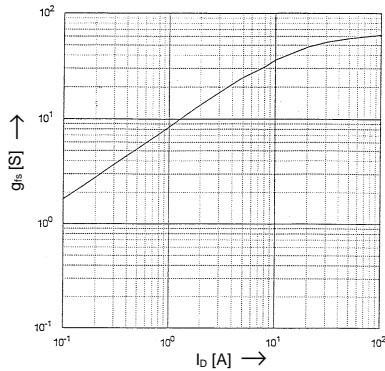

Gate Threshold Voltage vs. T_{ch}

$V_{GS(th)}=f(T_{ch})$; $I_D=1\text{mA}$; $V_{DS}=V_{GS}$

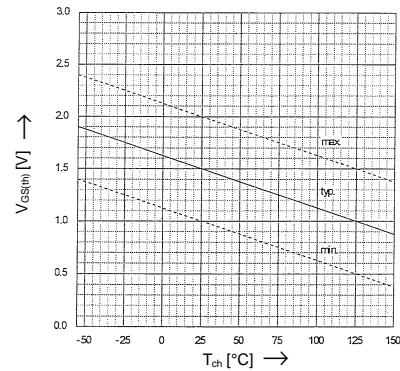

Typical Capacitances vs. V_{DS}

$C=f(V_{DS})$; $V_{GS}=0\text{V}$; $f=1\text{MHz}$

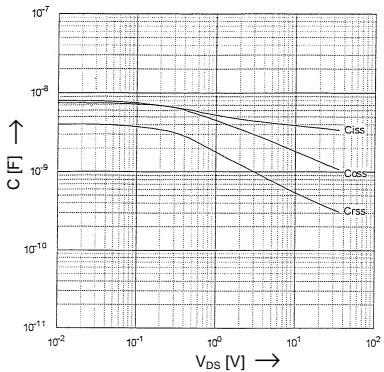

Typical Gate Charge Characteristic

$V_{GS}=f(Q_g)$; $I_D=80\text{A}$; $T_C=25^\circ\text{C}$

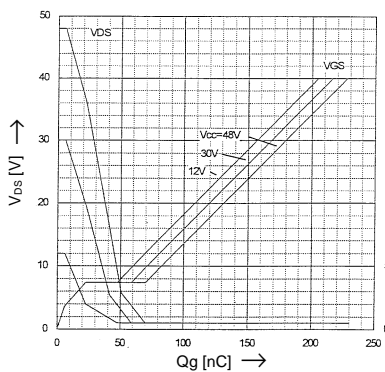

Forward Characteristics of Reverse Diode

$I_F=f(V_{SD})$; 80μs pulse test; $T_{ch}=25^\circ\text{C}$

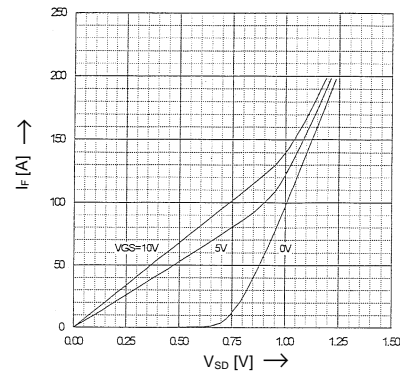

Maximum Avalanche Energy vs. starting T_{ch}

$E_{AV}=f(\text{starting } T_{ch})$; $V_{CC}=24\text{V}$; $I_{AV} \leq 50\text{A}$

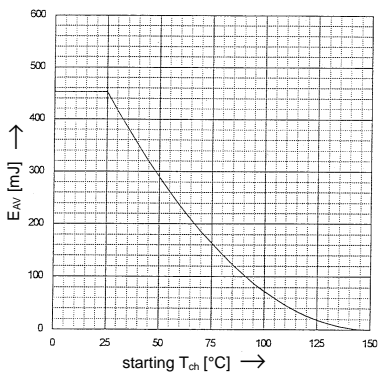

Safe Operation Area

$I_D=f(V_{DS})$; $D=0,01$; $T_C=25^\circ\text{C}$

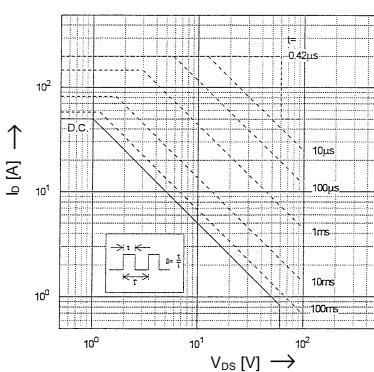

Transient Thermal impedance

Transient Thermal impedance

$Z_{th(ch-e)}=f(t)$ parameter: $D=t/T$

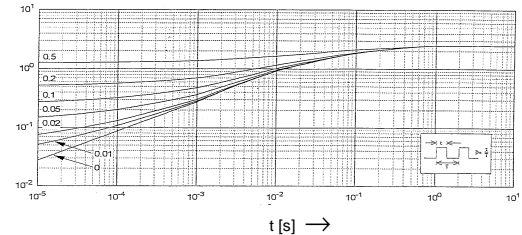

N-channel MOS-FET			
60V	0,01Ω	50A	50W

2SK2809-01MR

FAP-IIIB Series



> Characteristics

Power Dissipation
 $P_D=f(T_c)$

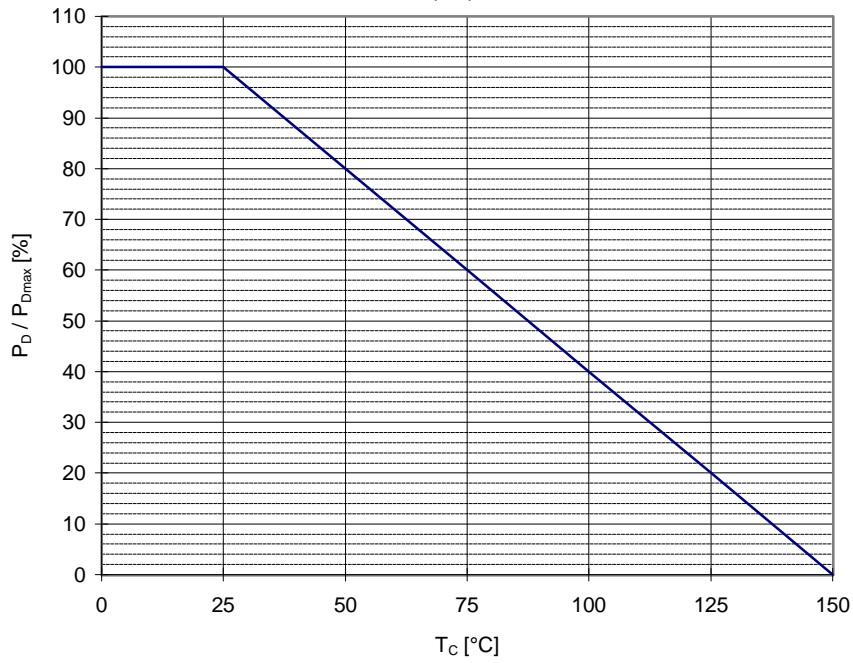

Maximum Avalanche Current vs. starting T_{ch}
 $I_{AV}=f(\text{starting } T_{ch})$

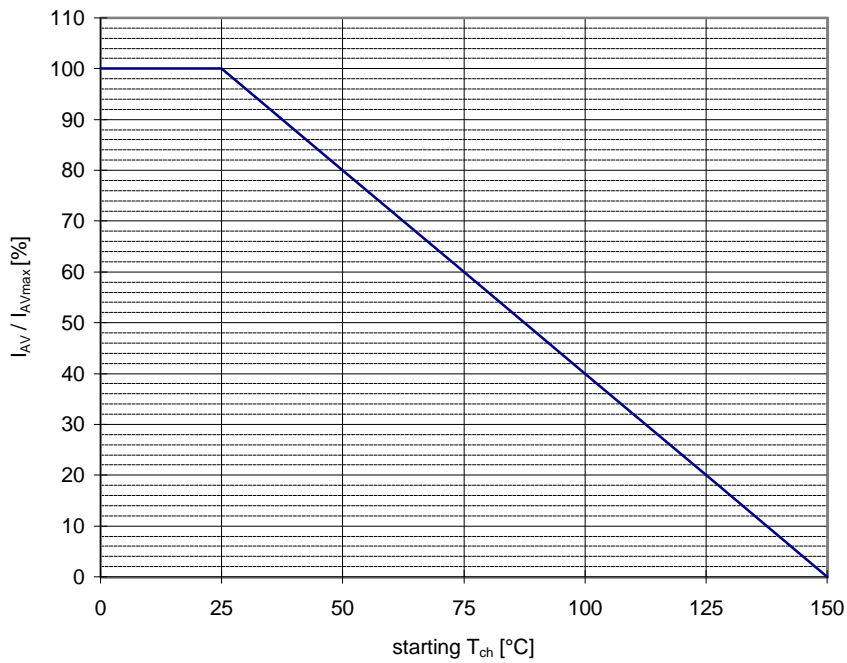



LittleDiode supplies new, hard to find or obsolete electronic components and semiconductors all over the world.

With over two million different components listed you are sure to find the part you need.

Feel free to visit us today at our online store:

LittleDiode.com

Looking forward to providing you with the best possible service.