

> **Features**

- High Speed Switching
- Low On-Resistance
- No Secondary Breakdown
- Low Driving Power
- High Voltage
- $V_{GS} = \pm 30V$  Guarantee
- Repetitive Avalanche Rated

> **Applications**

- Switching Regulators
- UPS
- DC-DC converters
- General Purpose Power Amplifier

> **Outline Drawing**

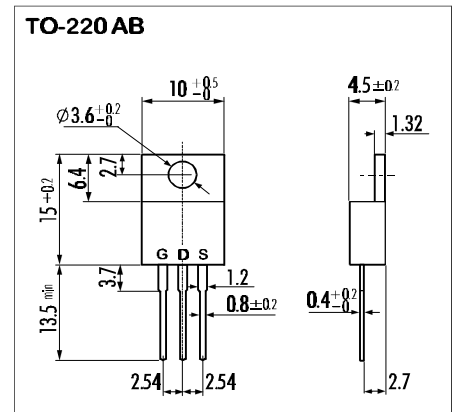

> **Maximum Ratings and Characteristics**

- Absolute Maximum Ratings( $T_C=25^\circ C$ ), unless otherwise specified

Item	Symbol	Rating	Unit
Drain-Source-Voltage	$V_{DS}$	800	V
Continous Drain Current	$I_D$	4	A
Pulsed Drain Current	$I_{D(puls)}$	16	A
Gate-Source-Voltage	$V_{GS}$	$\pm 30$	V
Repetitive or Non-Repetitive ( $T_{ch} \leq 150^\circ C$ )	$I_{AR}$	4	A
Avalanche Energy	$E_{AS}$	254	mJ
Max. Power Dissipation	$P_D$	80	W
Operating and Storage Temperature Range	$T_{ch}$	150	$^\circ C$
	$T_{stg}$	-55 ~ +150	$^\circ C$

> **Equivalent Circuit**

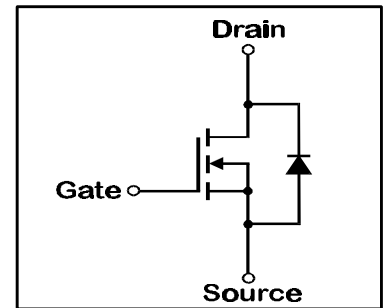

- Electrical Characteristics ( $T_C=25^\circ C$ ), unless otherwise specified

Item	Symbol	Test conditions	Min.	Typ.	Max.	Unit
Drain-Source Breakdown-Voltage	$V_{(BR)DSS}$	$I_D=1mA$ $V_{GS}=0V$	800			V
Gate Threshold Voltage	$V_{GS(th)}$	$I_D=1mA$ $V_{DS}=V_{GS}$	3,5	4,0	4,5	V
Zero Gate Voltage Drain Current	$I_{DSS}$	$V_{DS}=800V$ $T_{ch}=25^\circ C$		10	500	$\mu A$
		$V_{GS}=0V$ $T_{ch}=125^\circ C$		0,2	1,0	mA
Gate Source Leakage Current	$I_{GSS}$	$V_{GS}=\pm 30V$ $V_{DS}=0V$		10	100	nA
Drain Source On-State Resistance	$R_{DS(on)}$	$I_D=2A$ $V_{GS}=10V$		3,19	4,0	$\Omega$
Forward Transconductance	$g_{fs}$	$I_D=2A$ $V_{DS}=25V$		2		S
Input Capacitance	$C_{iss}$	$V_{DS}=25V$		450		pF
Output Capacitance	$C_{oss}$	$V_{GS}=0V$		75		pF
Reverse Transfer Capacitance	$C_{rss}$	$f=1MHz$		40		pF
Turn-On-Time $t_{on}$ ( $t_{on}=t_{d(on)}+t_r$ )	$t_{d(on)}$	$V_{CC}=600V$		20		ns
		$I_D=2A$		40		ns
Turn-Off-Time $t_{off}$ ( $t_{off}=t_{d(off)}+t_f$ )	$t_{d(off)}$	$V_{GS}=10V$		50		ns
		$R_{GS}=10 \Omega$		25		ns
Avalanche Capability	$I_{AV}$	$L = 100\mu H$ $T_{ch}=25^\circ C$	4			A
Diode Forward On-Voltage	$V_{SD}$	$I_F=2I_{DR}$ $V_{GS}=0V$ $T_{ch}=25^\circ C$		1,0		V
Reverse Recovery Time	$t_{rr}$	$I_F=I_{DR}$ $V_{GS}=0V$		450		ns
Reverse Recovery Charge	$Q_{rr}$	$-dI_F/dt=100A/\mu s$ $T_{ch}=25^\circ C$		3,0		$\mu C$

- Thermal Characteristics

Item	Symbol	Test conditions	Min.	Typ.	Max.	Unit
Thermal Resistance	$R_{th(ch-a)}$	channel to air			75	$^\circ C/W$
	$R_{th(ch-c)}$	channel to case			1,56	$^\circ C/W$

N-channel MOS-FET			
800V	4Ω	4A	80W

# 2SK2646-01

## FAP-IIS Series



### > Characteristics

Typical Output Characteristics

$I_D=f(V_{DS})$ ; 80μs pulse test;  $T_C=25^\circ\text{C}$

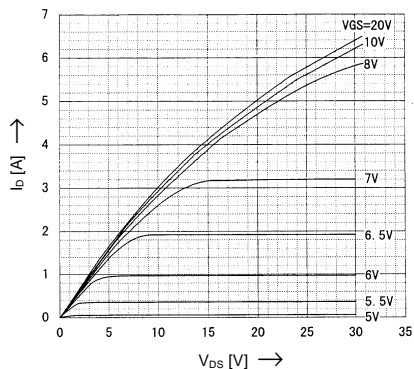

Drain-Source-On-State Resistance vs.  $T_{ch}$

$R_{DS(on)}=f(T_{ch})$ ;  $I_D=2\text{A}$ ;  $V_{GS}=10\text{V}$

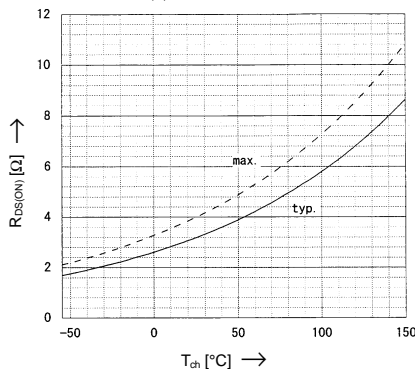

Typical Transfer Characteristics

$I_D=f(V_{GS})$ ; 80μs pulse test;  $V_{DS}=25\text{V}$ ;  $T_{ch}=25^\circ\text{C}$

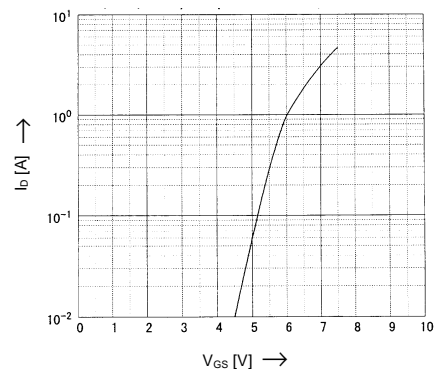

Typical Drain-Source-On-State-Resistance vs.  $I_D$

$R_{DS(on)}=f(I_D)$ ; 80μs pulse test;  $T_C=25^\circ\text{C}$

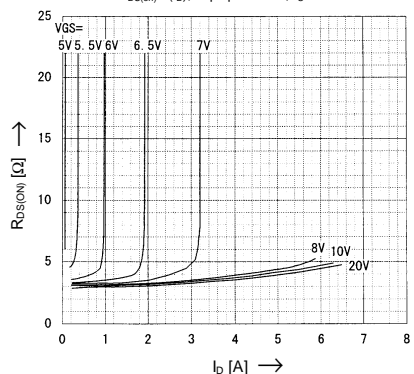

Typical Forward Transconductance vs.  $I_D$

$g_{fs}=f(I_D)$ ; 80μs pulse test;  $V_{DS}=25\text{V}$ ;  $T_{ch}=25^\circ\text{C}$

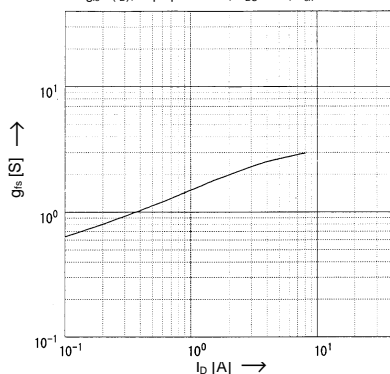

Gate Threshold Voltage vs.  $T_{ch}$

$V_{GS(th)}=f(T_{ch})$ ;  $I_D=1\text{mA}$ ;  $V_{DS}=V_{GS}$

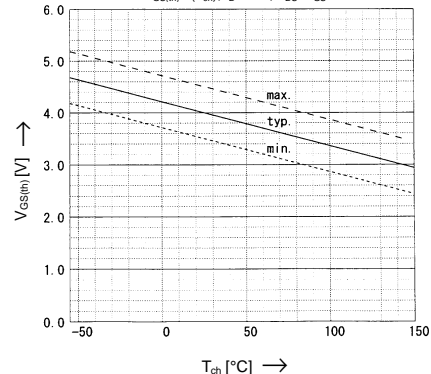

Typical Capacitances vs.  $V_{DS}$

$C=f(V_{DS})$ ;  $V_{GS}=0\text{V}$ ;  $f=1\text{MHz}$

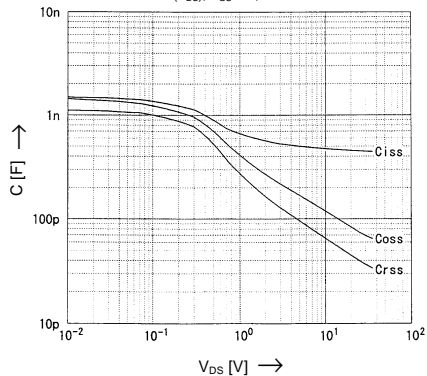

Avalanche Energy Derating

$E_{AS}=f(\text{starting } T_{ch})$ ;  $V_{CC}=80\text{V}$ ;  $I_{AV}=4\text{A}$

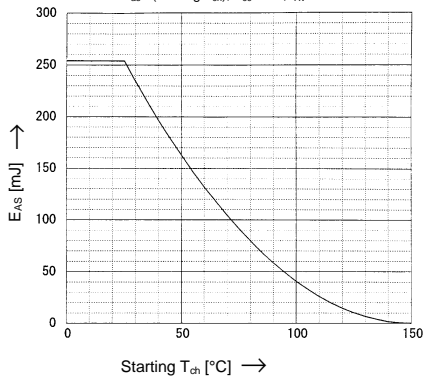

Forward Characteristics of Reverse Diode

$I_F=f(V_{SD})$ ; 80μs pulse test;  $V_{GS}=0\text{V}$

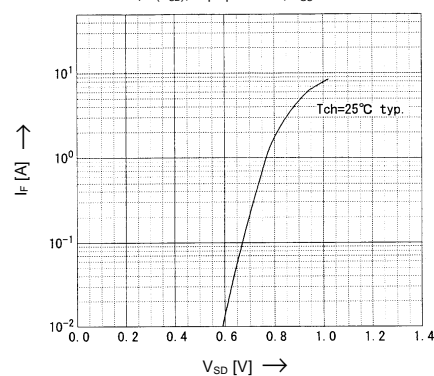

Power Dissipation

$P_D=f(T_C)$

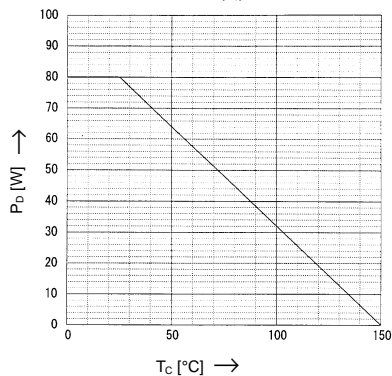

Safe operation area

$I_D=f(V_{DS})$ ;  $D=0.01$ ;  $T_C=25^\circ\text{C}$

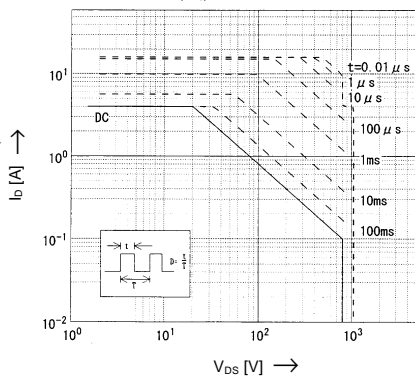

Transient Thermal impedance

Transient Thermal impedance

$Z_{th(ch-e)}=f(t)$  parameter:  $D=l/T$

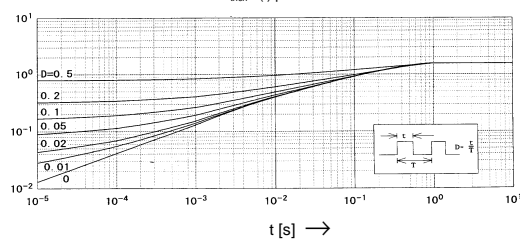



LittleDiode supplies new, hard to find or obsolete electronic components and semiconductors all over the world.

With over two million different components listed you are sure to find the part you need.

Feel free to visit us today at our online store:

[LittleDiode.com](http://LittleDiode.com)

Looking forward to providing you with the best possible service.