

> **Features**

- High Current
- Low On-Resistance
- No Secondary Breakdown
- Low Driving Power
- High Forward Transconductance

> **Applications**

- Motor Control
- General Purpose Power Amplifier
- DC-DC converters

> **Outline Drawing**

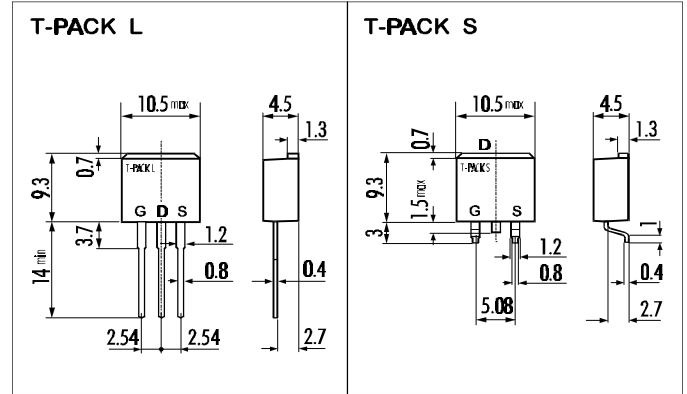

> **Maximum Ratings and Characteristics**

- Absolute Maximum Ratings ($T_C=25^\circ\text{C}$), unless otherwise specified

Item	Symbol	Rating	Unit
Drain-Source-Voltage	V_{DS}	30	V
Drain-Gate-Voltage ($R_{GS}=20K\Omega$)	V_{DGR}	30	V
Continuous Drain Current	I_D	35	A
Pulsed Drain Current	$I_{D(puls)}$	140	A
Gate-Source-Voltage	V_{GS}	± 20	V
Max. Power Dissipation	P_D	60	W
Operating and Storage Temperature Range	T_{ch}	150	$^\circ\text{C}$
	T_{stg}	-55 ~ +150	$^\circ\text{C}$

> **Equivalent Circuit**

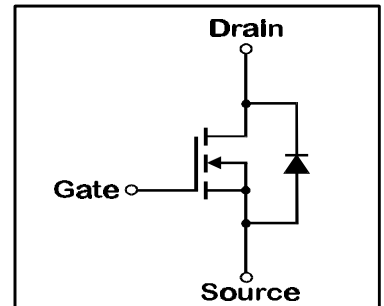

- Electrical Characteristics ($T_C=25^\circ\text{C}$), unless otherwise specified

Item	Symbol	Test conditions	Min.	Typ.	Max.	Unit
Drain-Source Breakdown-Voltage	$V_{(BR)DSS}$	$I_D=1\text{mA}$ $V_{GS}=0\text{V}$	30			V
Gate Threshold Voltage	$V_{GS(th)}$	$I_D=1\text{mA}$ $V_{DS}=V_{GS}$	1,0	1,5	2,5	V
Zero Gate Voltage Drain Current	I_{DSS}	$V_{DS}=30\text{V}$ $T_{ch}=25^\circ\text{C}$		10	500	μA
		$V_{GS}=0\text{V}$ $T_{ch}=125^\circ\text{C}$		0,2	1,0	mA
Gate Source Leakage Current	I_{GSS}	$V_{GS}=\pm 20\text{V}$ $V_{DS}=0\text{V}$		10	100	nA
Drain Source On-State Resistance	$R_{DS(on)}$	$I_D=17,5\text{A}$ $V_{GS}=4\text{V}$		0,025	0,037	Ω
		$I_D=17,5\text{A}$ $V_{GS}=10\text{V}$		0,016	0,022	Ω
Forward Transconductance	g_{fs}	$I_D=17,5\text{A}$ $V_{DS}=12\text{V}$	8	17		S
Input Capacitance	C_{iss}	$V_{DS}=25\text{V}$		1750	2630	pF
Output Capacitance	C_{oss}	$V_{GS}=0\text{V}$		800	1200	pF
Reverse Transfer Capacitance	C_{rss}	$f=1\text{MHz}$		400	600	pF
Turn-On-Time t_{on} ($t_{on}=t_{d(on)}+t_r$)	$t_{d(on)}$	$V_{CC}=12\text{V}$		25	38	ns
	t_r	$I_D=35\text{A}$		100	150	ns
Turn-Off-Time t_{off} ($t_{off}=t_{d(off)}+t_f$)	$t_{d(off)}$	$V_{GS}=10\text{V}$		300	450	ns
	t_f	$R_{GS}=25\Omega$		180	270	ns
Continuous Reverse Drain Current	I_{DR}				35	A
Pulsed Reverse Drain Current	I_{DRM}				140	A
Diode Forward On-Voltage	V_{SD}	$I_F=2I_{DR}$ $V_{GS}=0\text{V}$ $T_{ch}=25^\circ\text{C}$		1,35	2,0	V
Reverse Recovery Time	t_{rr}	$I_F=I_{DR}$ $V_{GS}=0\text{V}$		100		ns
Reverse Recovery Charge	Q_{rr}	$-di_F/dt=100\text{A}/\mu\text{s}$ $T_{ch}=25^\circ\text{C}$		0,5		μC

- Thermal Characteristics

Item	Symbol	Test conditions	Min.	Typ.	Max.	Unit
Thermal Resistance	$R_{th(ch-a)}$	channel to air			125	$^\circ\text{C}/\text{W}$
	$R_{th(ch-c)}$	channel to case			2,08	$^\circ\text{C}/\text{W}$

> Characteristics

Typical Output Characteristics

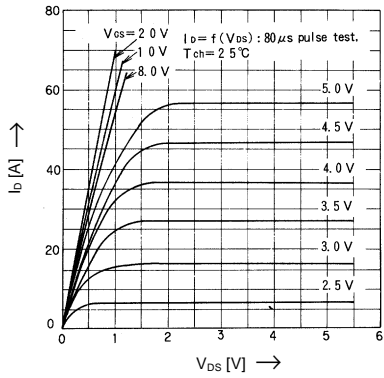

Drain-Source-On-State Resistance vs. T_{ch}

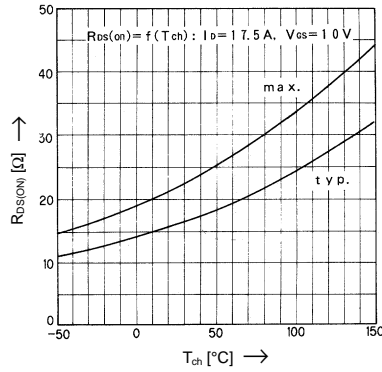

Typical Transfer Characteristics

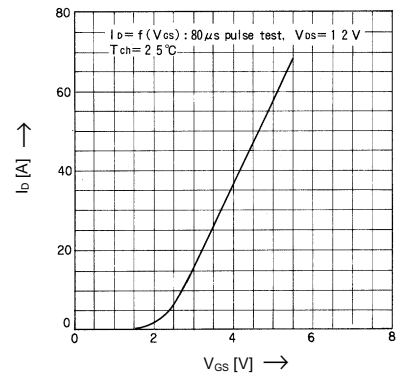

Typical Drain-Source-On-State-Resistance vs. I_D

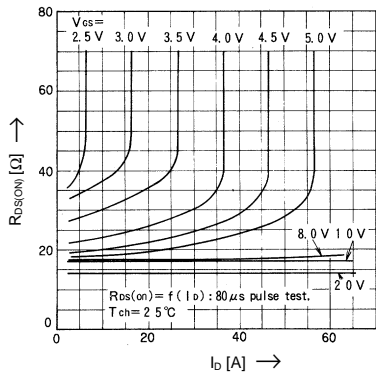

Typical Forward Transconductance vs. I_D

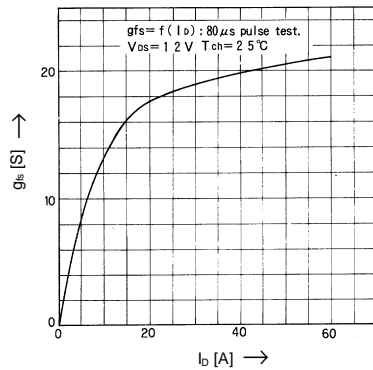

Gate Threshold Voltage vs. T_{ch}

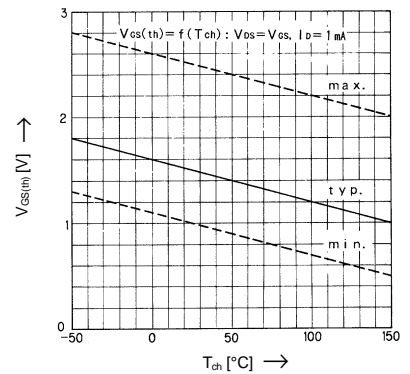

Typical Capacitance vs. V_{DS}

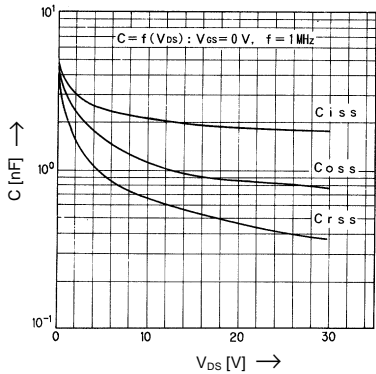

Typical Input Charge

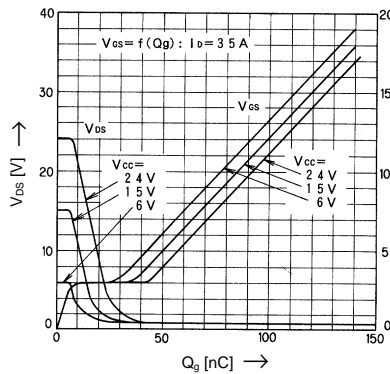

Forward Characteristics of Reverse Diode

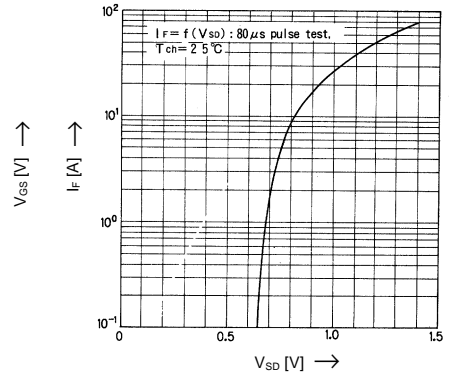

Allowable Power Dissipation vs. T_c

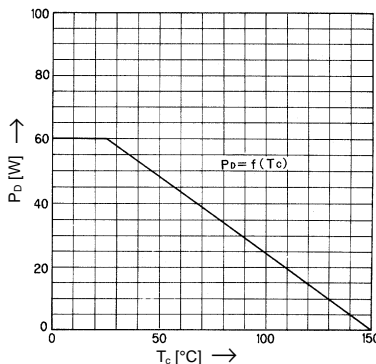

Safe operation area

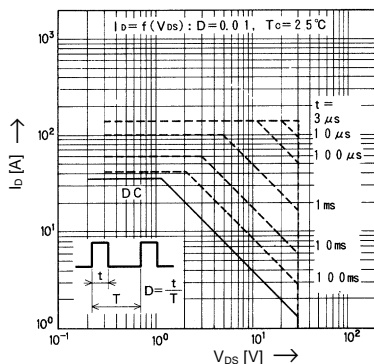

↑

Transient Thermal impedance

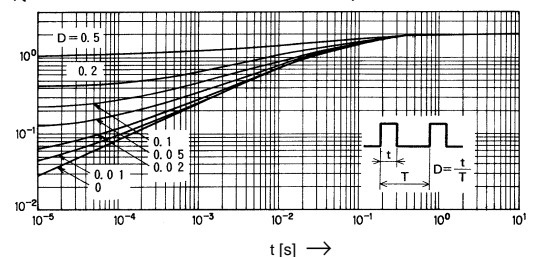



LittleDiode supplies new, hard to find or obsolete electronic components and semiconductors all over the world.

With over two million different components listed you are sure to find the part you need.

Feel free to visit us today at our online store:

LittleDiode.com

Looking forward to providing you with the best possible service.