

> **Features**

- High Speed Switching
- Low On-Resistance
- No Secondary Breakdown
- Low Driving Power
- High Voltage
- $V_{GS} = \pm 30V$  Guarantee
- Avalanche Proof

> **Applications**

- Switching Regulators
- UPS
- DC-DC converters
- General Purpose Power Amplifier

> **Outline Drawing**

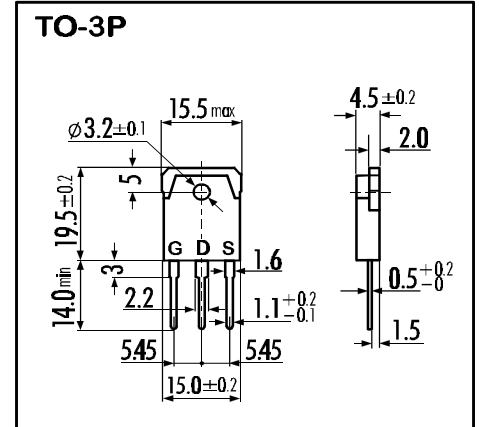

> **Maximum Ratings and Characteristics**

- Absolute Maximum Ratings ( $T_C=25^\circ C$ ), unless otherwise specified

| Item                                      | Symbol        | Rating     | Unit       |
|---|---------------|------------|------------|
| Drain-Source-Voltage                      | $V_{DS}$      | 500        | V          |
| Drain-Gate-Voltage ( $R_{GS}=20K\Omega$ ) | $V_{DGR}$     | 500        | V          |
| Continous Drain Current                   | $I_D$         | 10         | A          |
| Pulsed Drain Current                      | $I_{D(puls)}$ | 40         | A          |
| Gate-Source-Voltage                       | $V_{GS}$      | $\pm 30$   | V          |
| Max. Power Dissipation                    | $P_D$         | 100        | W          |
| Operating and Storage Temperature Range   | $T_{ch}$      | 150        | $^\circ C$ |
|   | $T_{stg}$     | -55 ~ +150 | $^\circ C$ |

> **Equivalent Circuit**

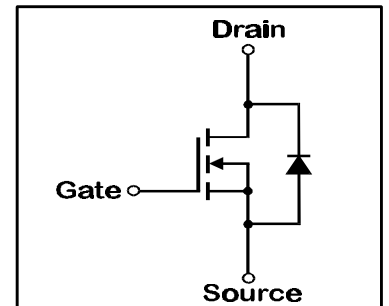

- Electrical Characteristics ( $T_C=25^\circ C$ ), unless otherwise specified

| Item   | Symbol        | Test conditions                               | Min. | Typ. | Max. | Unit     |
|--|---------------|---|------|------|------|----------|
| Drain-Source Breakdown-Voltage                       | $V_{(BR)DSS}$ | $I_D=1mA$ $V_{GS}=0V$                         | 500  |      |      | V        |
| Gate Threshold Voltage                               | $V_{GS(th)}$  | $I_D=1mA$ $V_{DS}=V_{GS}$                     | 2,5  | 3,0  | 3,5  | V        |
| Zero Gate Voltage Drain Current                      | $I_{DSS}$     | $V_{DS}=500V$ $T_{ch}=25^\circ C$             |      | 10   | 500  | $\mu A$  |
|  |               | $V_{GS}=0V$ $T_{ch}=125^\circ C$              |      | 0,2  | 1,0  | mA       |
| Gate Source Leakage Current                          | $I_{GSS}$     | $V_{GS}=\pm 30V$ $V_{DS}=0V$                  |      | 10   | 100  | nA       |
| Drain Source On-State Resistance                     | $R_{DS(on)}$  | $I_D=5A$ $V_{GS}=10V$                         |      | 0,6  | 0,76 | $\Omega$ |
| Forward Transconductance                             | $g_{fs}$      | $I_D=5A$ $V_{DS}=25V$                         | 5,0  | 10,0 |      | S        |
| Input Capacitance                                    | $C_{iss}$     | $V_{DS}=25V$                                  |      | 1500 | 2200 | pF       |
| Output Capacitance                                   | $C_{oss}$     | $V_{GS}=0V$                                   |      | 160  | 240  | pF       |
| Reverse Transfer Capacitance                         | $C_{rss}$     | $f=1MHz$                                      |      | 35   | 50   | pF       |
| Turn-On-Time $t_{on}$ ( $t_{on}=t_{d(on)}+t_r$ )     | $t_{d(on)}$   | $V_{CC}=300V$                                 |      | 15   | 25   | ns       |
|  |               | $I_D=10A$                                     |      | 40   | 60   | ns       |
| Turn-Off-Time $t_{off}$ ( $t_{off}=t_{d(off)}+t_f$ ) | $t_{d(off)}$  | $V_{GS}=10V$                                  |      | 70   | 100  | ns       |
|  |               | $R_{GS}=10\Omega$                             |      | 60   | 90   | ns       |
| Avalanche Capability                                 | $I_{AV}$      | $L = 100\mu H$ $T_{ch}=25^\circ C$            | 10   |      |      | A        |
| Continous Reverse Drain Current                      | $I_{DR}$      |   |      |      | 10   | A        |
| Pulsed Reverse Drain Current                         | $I_{DRM}$     |   |      |      | 40   | A        |
| Diode Forward On-Voltage                             | $V_{SD}$      | $I_F=2I_{DR}$ $V_{GS}=0V$ $T_{ch}=25^\circ C$ |      | 1,12 | 1,70 | V        |
| Reverse Recovery Time                                | $t_{rr}$      | $I_F=I_{DR}$ $V_{GS}=0V$                      |      | 450  |      | ns       |
| Reverse Recovery Charge                              | $Q_{rr}$      | $-dI_F/dt=100A/\mu s$ $T_{ch}=25^\circ C$     |      | 3    |      | $\mu C$  |

- Thermal Characteristics

| Item               | Symbol         | Test conditions | Min. | Typ. | Max. | Unit         |
|--------------------|----------------|-----------------|------|------|------|--------------|
| Thermal Resistance | $R_{th(ch-a)}$ | channel to air  |      |      | 35   | $^\circ C/W$ |
|                    | $R_{th(ch-c)}$ | channel to case |      |      | 1,25 | $^\circ C/W$ |

|                   |       |     |      |
|-------------------|-------|-----|------|
| N-channel MOS-FET |       |     |      |
| 500V              | 0,76Ω | 10A | 100W |

# 2SK1936-01

## FAP-IIA Series



### > Characteristics

Typical Output Characteristics

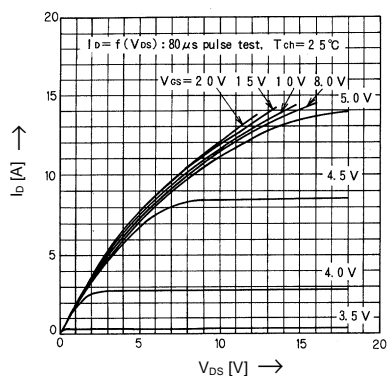

Drain-Source-On-State Resistance vs.  $T_{ch}$

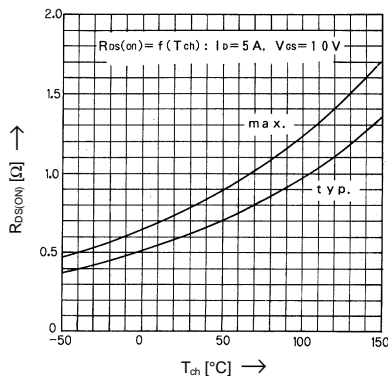

Typical Transfer Characteristics

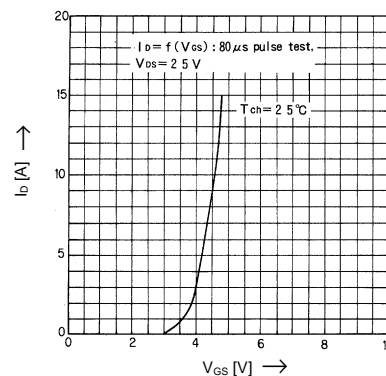

Typical Drain-Source-On-State-Resistance vs.  $I_D$

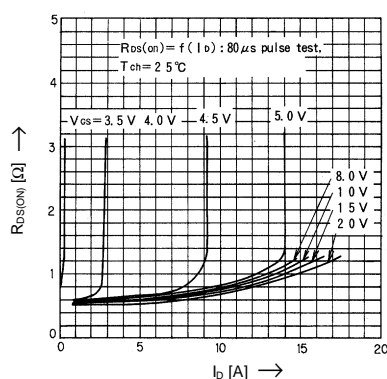

Typical Forward Transconductance vs.  $I_D$

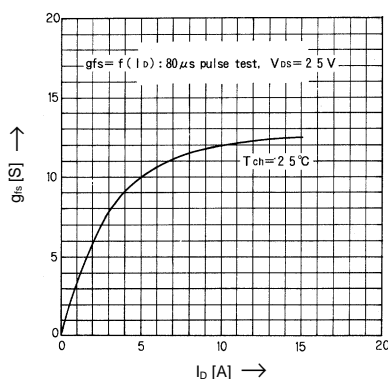

Gate Threshold Voltage vs.  $T_{ch}$

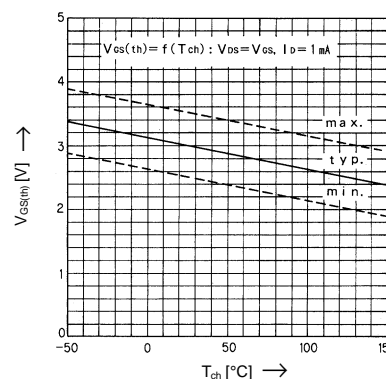

Typical Capacitance vs.  $V_{DS}$

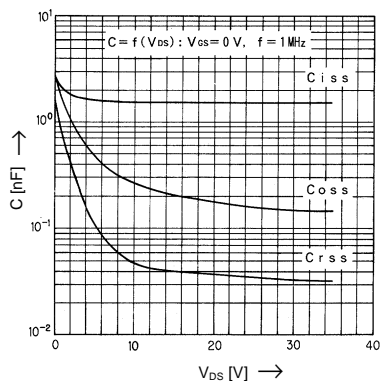

Typical Input Charge

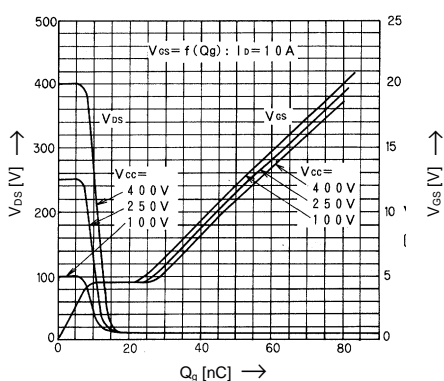

Forward Characteristics of Reverse Diode

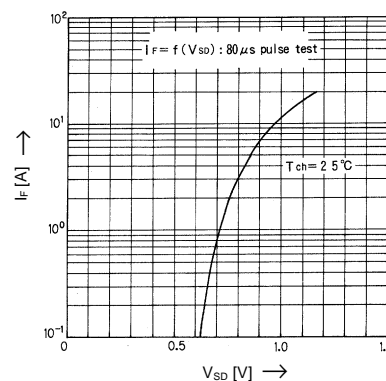

Allowable Power Dissipation vs.  $T_c$

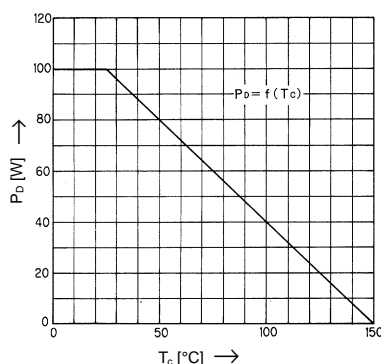

Safe operation area

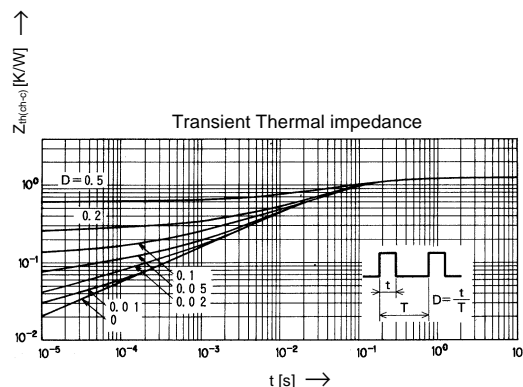
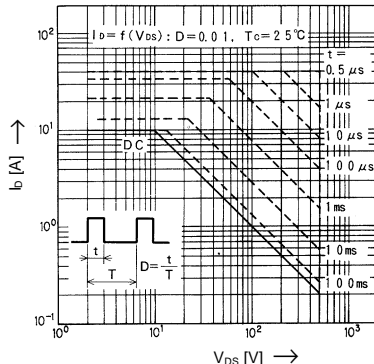



LittleDiode supplies new, hard to find or obsolete electronic components and semiconductors all over the world.

With over two million different components listed you are sure to find the part you need.

Feel free to visit us today at our online store:

[LittleDiode.com](http://LittleDiode.com)

Looking forward to providing you with the best possible service.