

> **Features**

- High Current
- Low On-Resistance
- No Secondary Breakdown
- Low Driving Power
- High Forward Transconductance

> **Applications**

- Motor Control
- General Purpose Power Amplifier
- DC-DC converters

> **Outline Drawing**

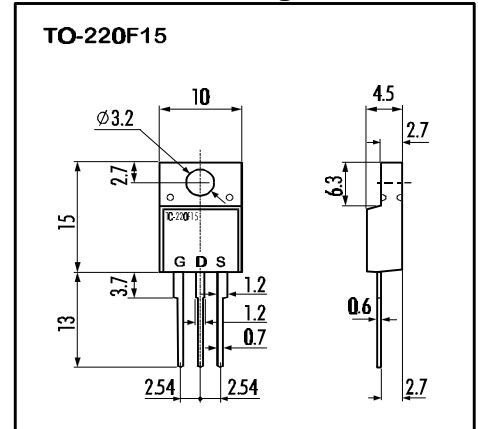

> **Maximum Ratings and Characteristics**

- Absolute Maximum Ratings ($T_C=25^\circ\text{C}$), unless otherwise specified

Item	Symbol	Rating	Unit
Drain-Source-Voltage	V_{DS}	100	V
Continuous Drain Current	I_D	20	A
Pulsed Drain Current	$I_{D(puls)}$	80	A
Continuous Reverse Drain Current	I_{DR}	20	A
Gate-Source-Voltage	V_{GS}	± 20	V
Max. Power Dissipation	P_D	40	W
Operating and Storage Temperature Range	T_{ch}	150	$^\circ\text{C}$
	T_{stg}	-55 ~ +150	$^\circ\text{C}$

> **Equivalent Circuit**

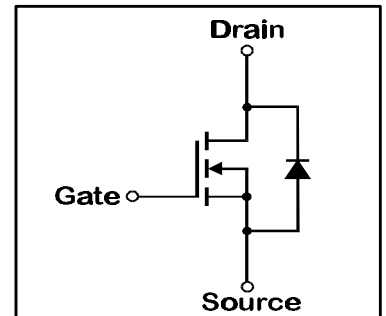

- Electrical Characteristics ($T_C=25^\circ\text{C}$), unless otherwise specified

Item	Symbol	Test conditions	Min.	Typ.	Max.	Unit
Drain-Source Breakdown-Voltage	$V_{(BR)DSS}$	$I_D=1\text{mA}$ $V_{GS}=0\text{V}$	100			V
Gate Threshold Voltage	$V_{GS(th)}$	$I_D=1\text{mA}$ $V_{DS}=V_{GS}$	1,0	1,5	2,5	V
Zero Gate Voltage Drain Current	I_{DSS}	$V_{DS}=100\text{V}$ $T_{ch}=25^\circ\text{C}$		10	500	μA
		$V_{GS}=0\text{V}$ $T_{ch}=125^\circ\text{C}$		0,2	1,0	mA
Gate Source Leakage Current	I_{GSS}	$V_{GS}=\pm 20\text{V}$ $V_{DS}=0\text{V}$		10	100	nA
Drain Source On-State Resistance	$R_{DS(on)}$	$I_D=10\text{A}$ $V_{GS}=4\text{V}$		0,070	0,120	Ω
		$I_D=10\text{A}$ $V_{GS}=10\text{V}$		0,053	0,080	Ω
Forward Transconductance	g_{fs}	$I_D=10\text{A}$ $V_{DS}=25\text{V}$	10	20		S
Input Capacitance	C_{iss}	$V_{DS}=25\text{V}$		1850	2780	pF
Output Capacitance	C_{oss}	$V_{GS}=0\text{V}$		400	600	pF
Reverse Transfer Capacitance	C_{rss}	$f=1\text{MHz}$		120	180	pF
Turn-On-Time t_{on} ($t_{on}=t_{d(on)}+t_r$)	$t_{d(on)}$	$V_{CC}=30\text{V}$		5	8	ns
	t_r	$I_D=20\text{A}$		50	75	ns
Turn-Off-Time t_{off} ($t_{off}=t_{d(off)}+t_f$)	$t_{d(off)}$	$V_{GS}=10\text{V}$		350	530	ns
	t_f	$R_{GS}=25\Omega$		100	150	ns
Diode Forward On-Voltage	V_{SD}	$I_F=2 \times I_{DR}$ $V_{GS}=0\text{V}$ $T_{ch}=25^\circ\text{C}$		1,22	1,83	V
Reverse Recovery Time	t_{rr}	$I_F=I_{DR}$ $V_{GS}=0\text{V}$		70		ns
		$-di_F/dt=100\text{A}/\mu\text{s}$ $T_{ch}=25^\circ\text{C}$				

- Thermal Characteristics

Item	Symbol	Test conditions	Min.	Typ.	Max.	Unit
Thermal Resistance	$R_{th(ch-a)}$	channel to air			62,5	$^\circ\text{C}/\text{W}$
	$R_{th(ch-c)}$	channel to case			3,125	$^\circ\text{C}/\text{W}$

N-channel MOS-FET			
100V	0,08Ω	20A	40W

2SK1817-M

F-III Series



> Characteristics

Typical Output Characteristics

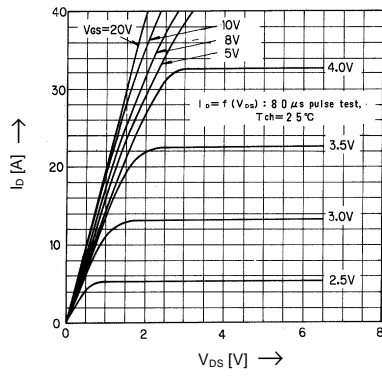

Drain-Source-On-State Resistance vs. T_{ch}

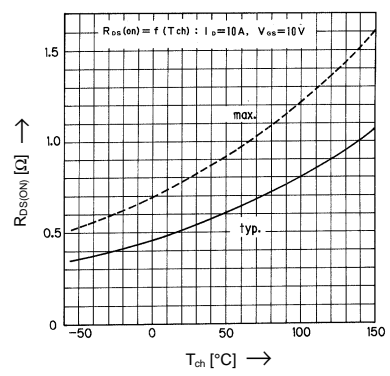

Typical Transfer Characteristics

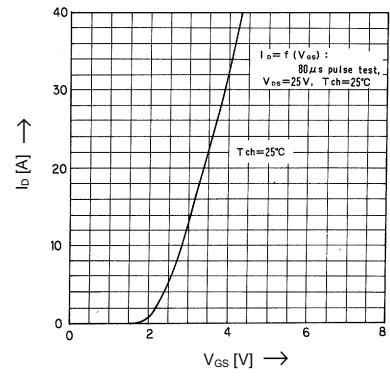

Typical Drain-Source-On-State-Resistance vs. I_D

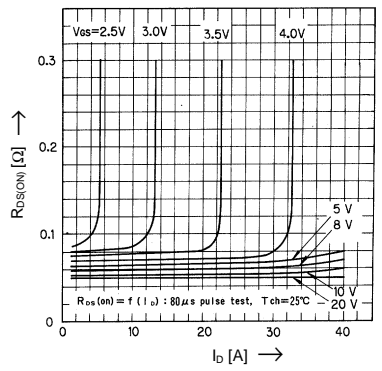

Typical Forward Transconductance vs. I_D

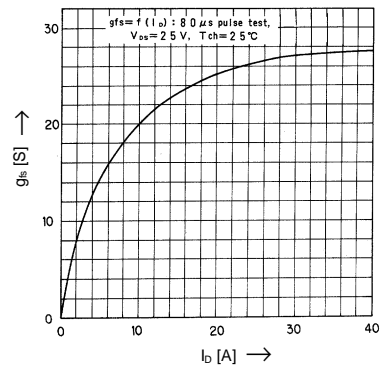

Gate Threshold Voltage vs. T_{ch}

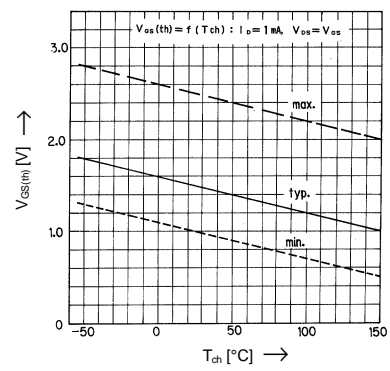

Typical Capacitance vs. V_{DS}

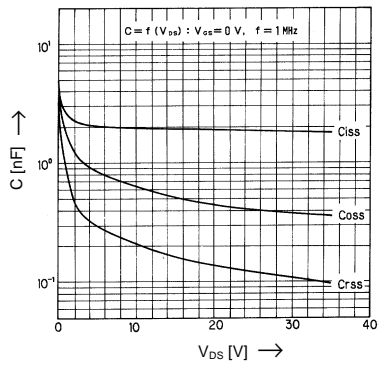

Typical Input Charge

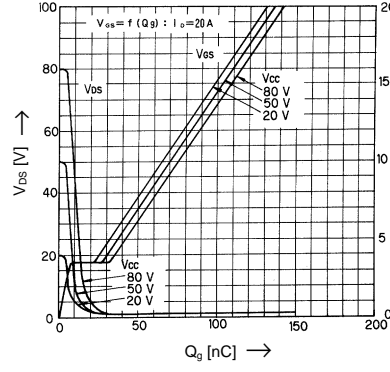

Forward Characteristics of Reverse Diode

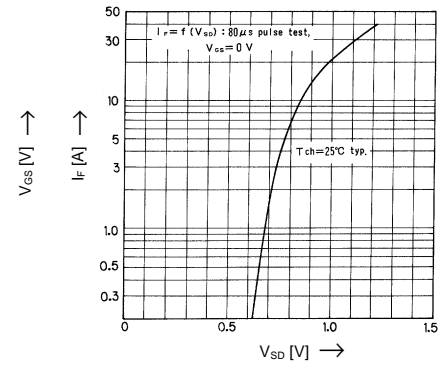

Allowable Power Dissipation vs. T_c

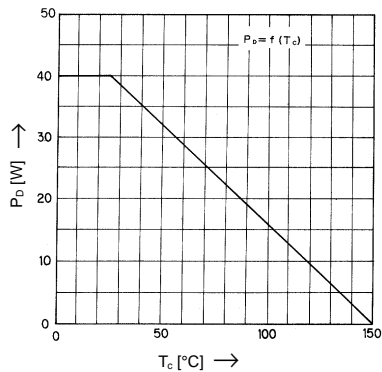

Safe operation area

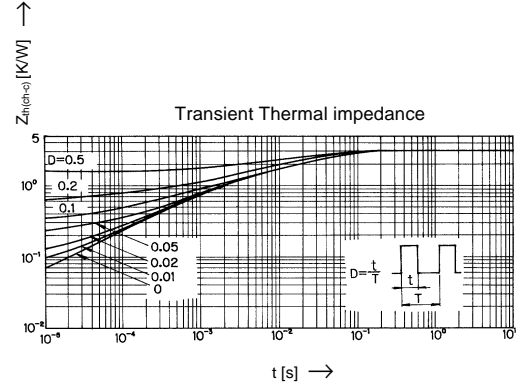
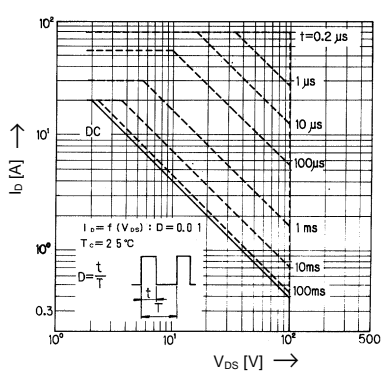



LittleDiode supplies new, hard to find or obsolete electronic components and semiconductors all over the world.

With over two million different components listed you are sure to find the part you need.

Feel free to visit us today at our online store:

LittleDiode.com

Looking forward to providing you with the best possible service.