

> **Features**

- High Current
- Low On-Resistance
- No Secondary Breakdown
- Low Driving Power
- High Forward Transconductance

> **Applications**

- Motor Control
- General Purpose Power Amplifier
- DC-DC converters

> **Outline Drawing**

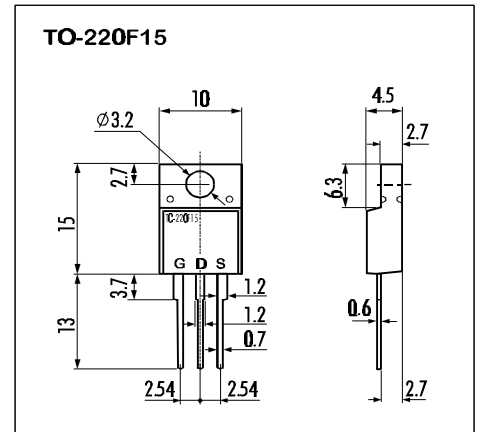

> **Maximum Ratings and Characteristics**

- Absolute Maximum Ratings ( $T_C=25^\circ\text{C}$ ), unless otherwise specified

Item	Symbol	Rating	Unit
Drain-Source-Voltage	$V_{DS}$	150	V
Continuous Drain Current	$I_D$	3	A
Pulsed Drain Current	$I_{D(puls)}$	12	A
Continuous Reverse Drain Current	$I_{DR}$	3	A
Gate-Source-Voltage	$V_{GS}$	$\pm 20$	V
Max. Power Dissipation	$P_D$	20	W
Operating and Storage Temperature Range	$T_{ch}$	150	$^\circ\text{C}$
	$T_{stg}$	-55 ~ +150	$^\circ\text{C}$

> **Equivalent Circuit**

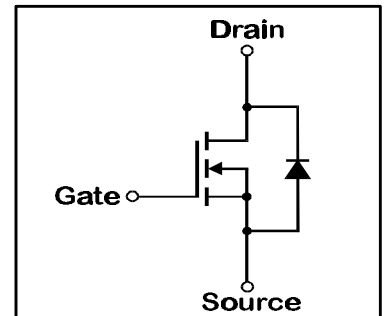

- Electrical Characteristics ( $T_C=25^\circ\text{C}$ ), unless otherwise specified

Item	Symbol	Test conditions	Min.	Typ.	Max.	Unit
Drain-Source Breakdown-Voltage	$V_{(BR)DSS}$	$I_D=1\text{mA}$ $V_{GS}=0\text{V}$	150			V
Gate Threshold Voltage	$V_{GS(th)}$	$I_D=1\text{mA}$ $V_{DS}=V_{GS}$	1,0	1,5	2,5	V
Zero Gate Voltage Drain Current	$I_{DSS}$	$V_{DS}=150\text{V}$ $T_{ch}=25^\circ\text{C}$		10	500	$\mu\text{A}$
		$V_{GS}=0\text{V}$ $T_{ch}=125^\circ\text{C}$		0,2	1,0	mA
Gate Source Leakage Current	$I_{GSS}$	$V_{GS}=\pm 20\text{V}$ $V_{DS}=0\text{V}$		10	100	nA
Drain Source On-State Resistance	$R_{DS(on)}$	$I_D=1,5\text{A}$ $V_{GS}=4\text{V}$		0,72	1,17	$\Omega$
		$I_D=1,5\text{A}$ $V_{GS}=10\text{V}$		0,60	0,90	$\Omega$
Forward Transconductance	$g_{fs}$	$I_D=1,5\text{A}$ $V_{DS}=25\text{V}$	1,5	3		S
Input Capacitance	$C_{iss}$	$V_{DS}=25\text{V}$		350	530	pF
Output Capacitance	$C_{oss}$	$V_{GS}=0\text{V}$		60	90	pF
Reverse Transfer Capacitance	$C_{rss}$	$f=1\text{MHz}$		15	23	pF
Turn-On-Time $t_{on}$ ( $t_{on}=t_{d(on)}+t_r$ )	$t_{d(on)}$	$V_{CC}=30\text{V}$		3	5	ns
	$t_r$	$I_D=3\text{A}$		30	45	ns
Turn-Off-Time $t_{off}$ ( $t_{off}=t_{d(off)}+t_f$ )	$t_{d(off)}$	$V_{GS}=10\text{V}$		60	90	ns
	$t_f$	$R_{GS}=25\Omega$		20	30	ns
Diode Forward On-Voltage	$V_{SD}$	$I_F=2 \times I_{DR}$ $V_{GS}=0\text{V}$ $T_{ch}=25^\circ\text{C}$		0,95	1,43	V
Reverse Recovery Time	$t_{rr}$	$I_F=I_{DR}$ $V_{GS}=0\text{V}$ $-di_F/dt=100\text{A}/\mu\text{s}$ $T_{ch}=25^\circ\text{C}$		70		ns

- Thermal Characteristics

Item	Symbol	Test conditions	Min.	Typ.	Max.	Unit
Thermal Resistance	$R_{th(ch-a)}$	channel to air			62,5	$^\circ\text{C}/\text{W}$
	$R_{th(ch-c)}$	channel to case			6,25	$^\circ\text{C}/\text{W}$

> Characteristics

Typical Output Characteristics

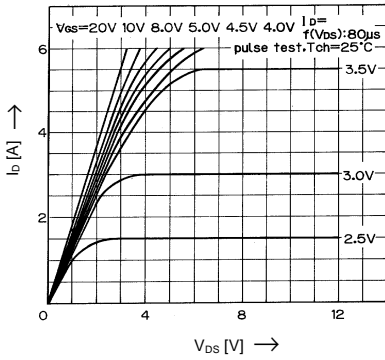

Drain-Source-On-State Resistance vs.  $T_{ch}$

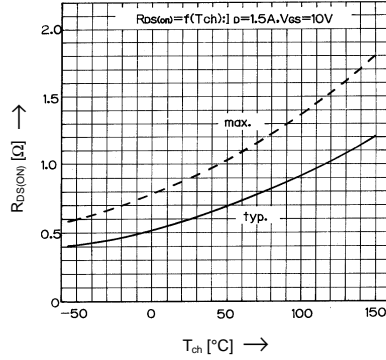

Typical Transfer Characteristics

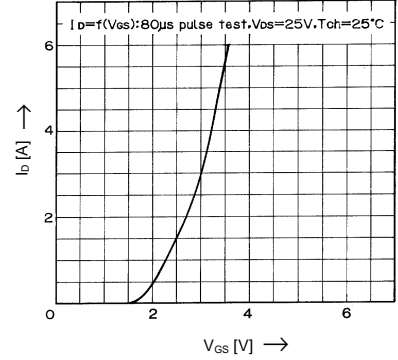

Typical Drain-Source-On-State-Resistance vs.  $I_D$

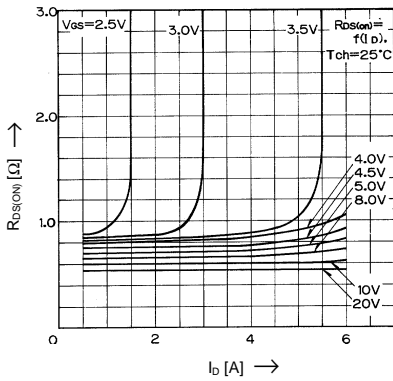

Typical Forward Transconductance vs.  $I_D$

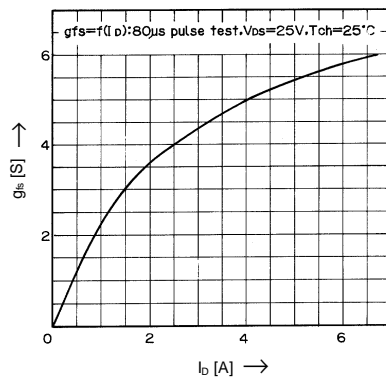

Gate Threshold Voltage vs.  $T_{ch}$

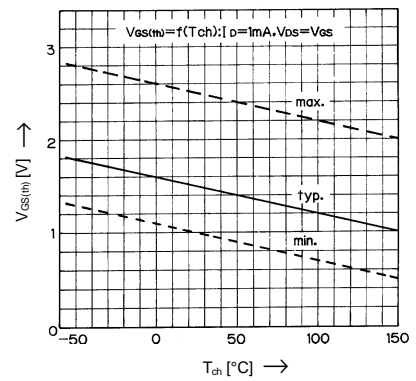

Typical Capacitance vs.  $V_{DS}$

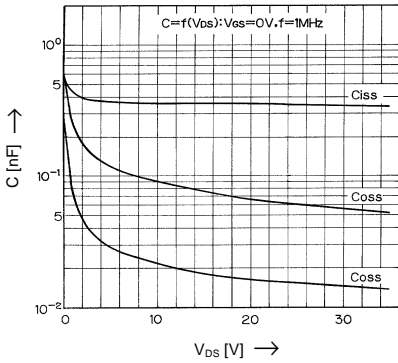

Typical Input Charge

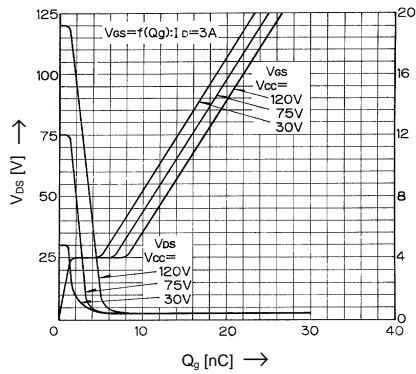

Forward Characteristics of Reverse Diode

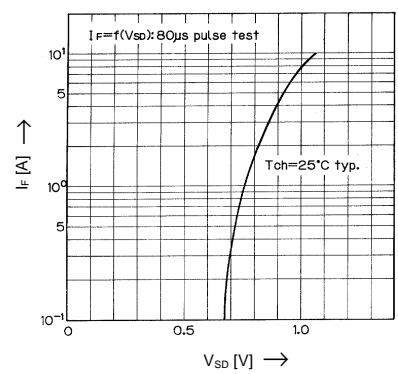

Allowable Power Dissipation vs.  $T_c$

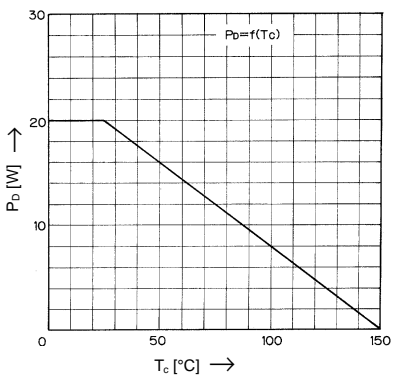

Safe operation area

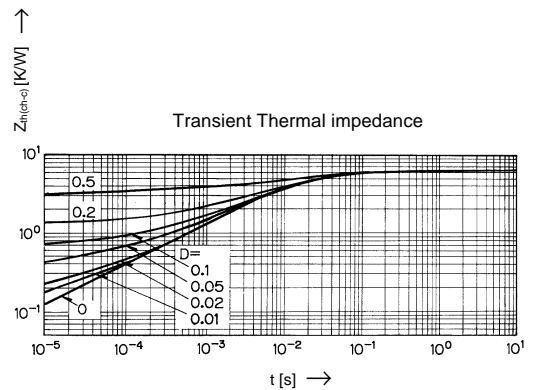
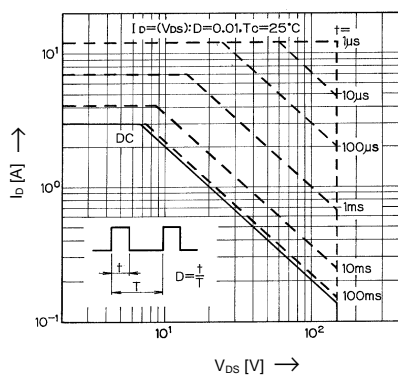



LittleDiode supplies new, hard to find or obsolete electronic components and semiconductors all over the world.

With over two million different components listed you are sure to find the part you need.

Feel free to visit us today at our online store:

**[LittleDiode.com](http://LittleDiode.com)**

Looking forward to providing you with the best possible service.