

2SJ586

Silicon P Channel MOS FET
High Speed Switching

HITACHI

ADE-208-771A (Z)
2nd.Edition.
June 1999

Features

- Low on-resistance
 $R_{DS} = 4.1$ typ. ($V_{GS} = -4$ V , $I_D = -50$ mA)
 $R_{DS} = 6.0$ typ. ($V_{GS} = -2.5$ V , $I_D = -50$ mA)
- 2.5 V gate drive device.
- Small package (CMPAK)

Outline

CMPAK

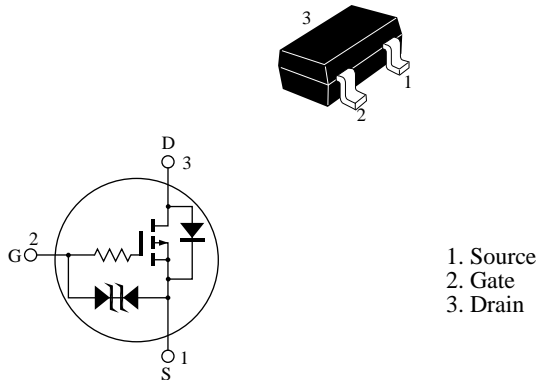

Absolute Maximum Ratings (Ta = 25°C)

Item	Symbol	Ratings	Unit
Drain to source voltage	V_{DSS}	-20	V
Gate to source voltage	V_{GSS}	±10	V
Drain current	I_D	-100	mA
Drain peak current	$I_{D(pulse)}$ ^{Note 1}	-400	mA
Body-drain diode reverse drain current	I_{DR}	-100	mA
Channel dissipation	Pch ^{Note 2}	300	mW
Channel temperature	Tch	150	°C
Storage temperature	Tstg	-55 to +150	°C

Note: 1. PW 10 μs, duty cycle 1%

2. Value on the alumina ceramic board (12.5x 20 x0.7 mm)

Electrical Characteristics (Ta = 25°C)

Item	Symbol	Min	Typ	Max	Unit	Test Conditions
Drain to source breakdown voltage	$V_{(BR)DSS}$	-20	—	—	V	$I_D = -100 \mu A, V_{GS} = 0$
Gate to source breakdown voltage	$V_{(BR)GSS}$	±10	—	—	V	$I_G = \pm 100 \mu A, V_{DS} = 0$
Gate to source leak current	I_{GSS}	—	—	±5	μA	$V_{GS} = \pm 8 V, V_{DS} = 0$
Zero gate voltage drain current	I_{DSS}	—	—	-1	μA	$V_{DS} = -20 V, V_{GS} = 0$
Gate to source cutoff voltage	$V_{GS(off)}$	-0.8	—	-1.8	V	$I_D = -10 \mu A, V_{DS} = -5 V$
Static drain to source on state resistance	$R_{DS(on)}$	—	4.1	5.0		$I_D = -50 mA, V_{GS} = -4 V$ ^{Note 3}
	$R_{DS(on)}$	—	6.0	8.5		$I_D = -50 mA, V_{GS} = -2.5 V$ ^{Note 3}
Forward transfer admittance	$ y_{fs} $	94	144	—	mS	$I_D = -50 mA, V_{DS} = -10 V$ ^{Note 3}
Input capacitance	Ciss	—	28	—	pF	$V_{DS} = -10 V$
Output capacitance	Coss	—	21	—	pF	$V_{GS} = 0$
Reverse transfer capacitance	Crss	—	7	—	pF	f = 1 MHz
Turn-on delay time	$t_{d(on)}$	—	30	—	ns	$I_D = -50 mA, V_{GS} = -4 V$
Rise time	t_r	—	90	—	ns	$R_L = 200$
Turn-off delay time	$t_{d(off)}$	—	87	—	ns	
Fall time	t_f	—	97	—	ns	

Note: 3. Pulse test

4. Marking is CP

Main Characteristics

Power vs. Temperature Derating

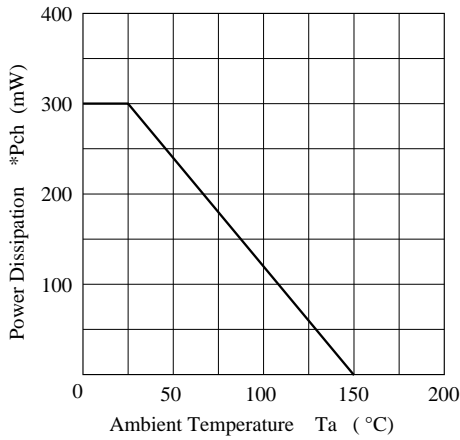

*Value on the alumina ceramic board.(12.5x20x0.7mm)

Maximum Safe Operation Area

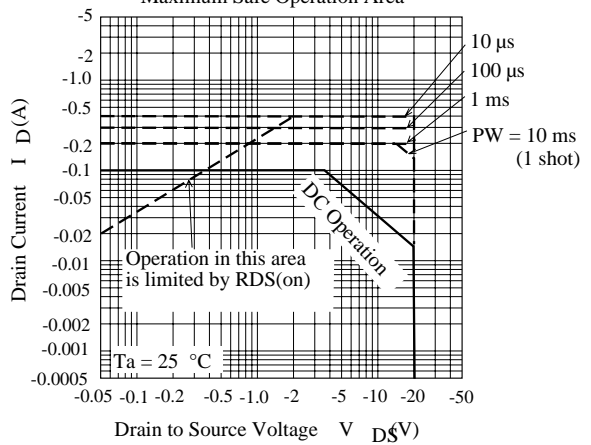

Value on the alumina ceramic board.(12.5x20x0.7mm)

Typical Output Characteristics

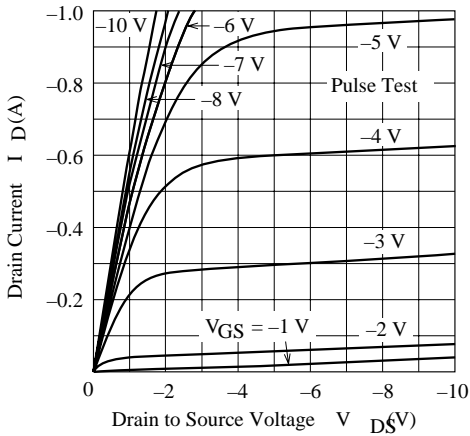

Typical Transfer Characteristics

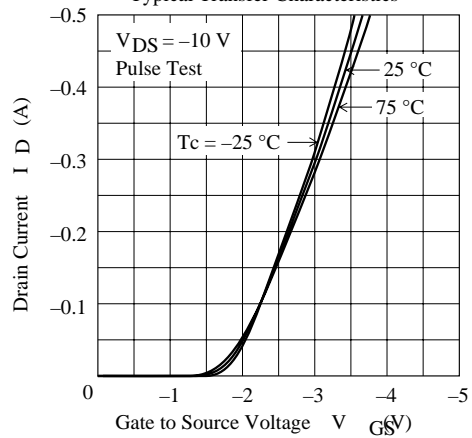

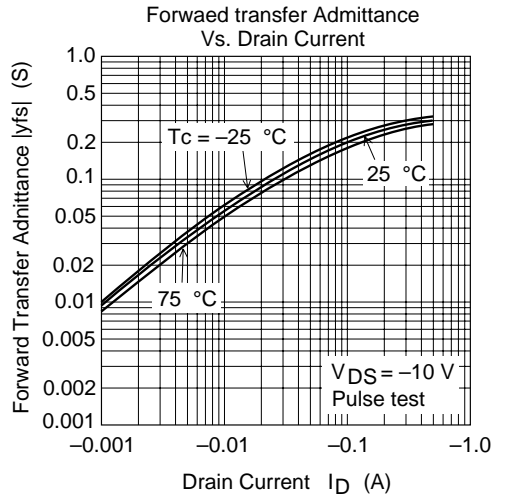
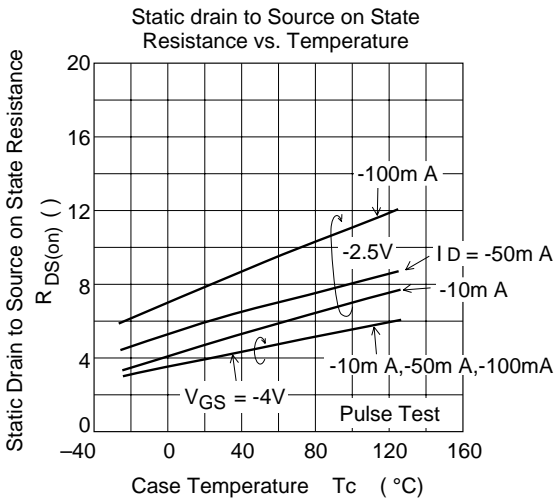
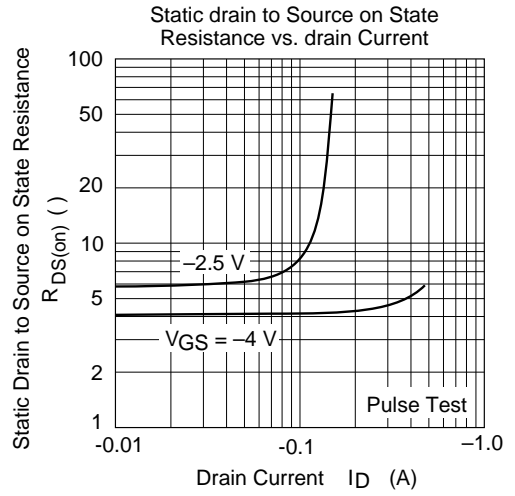
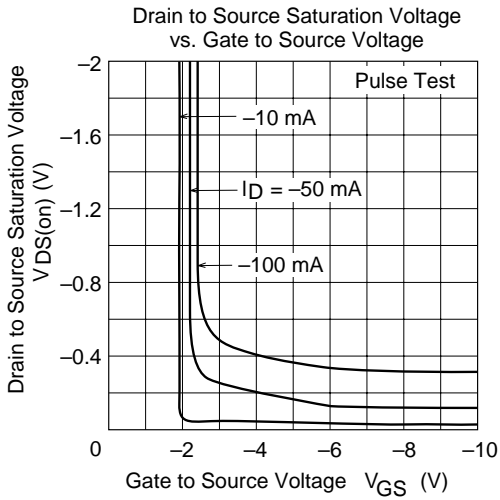

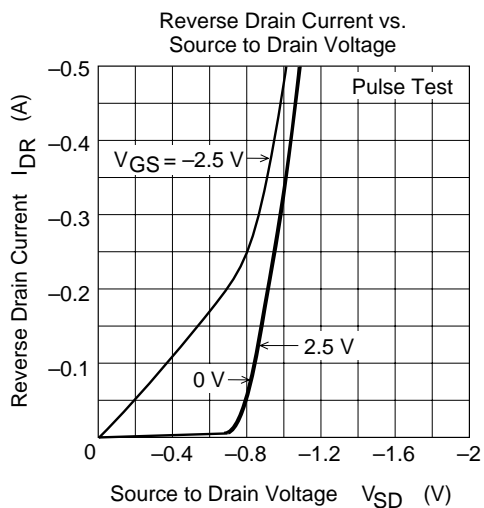
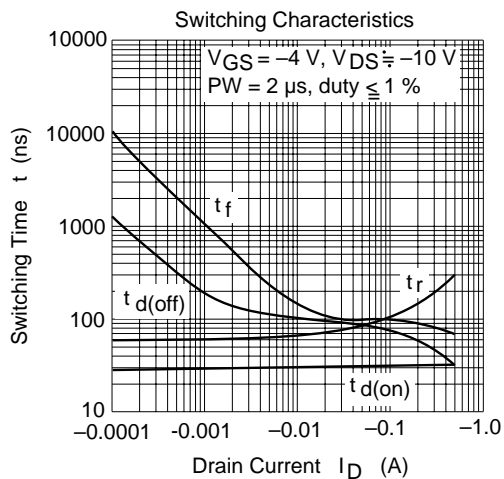
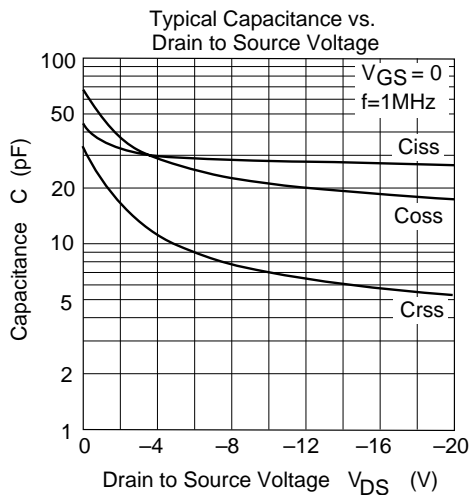

Switching Time Test Circuit

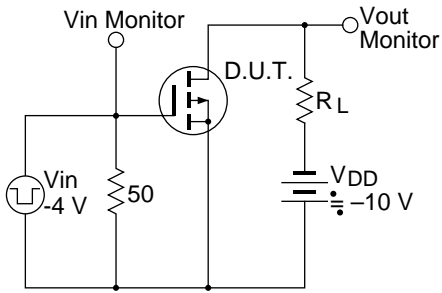

Waveforms

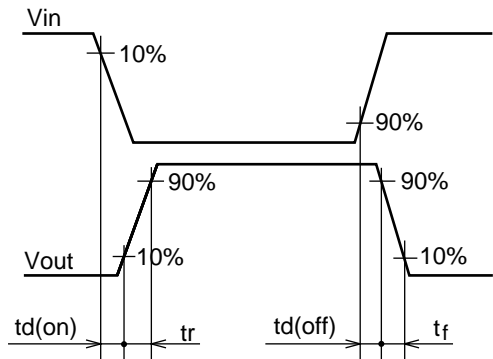

Package Dimensions

As of January, 2001

Unit: mm

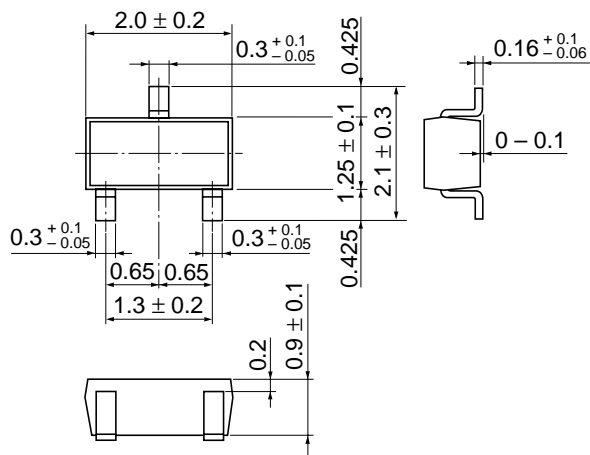

Hitachi Code	CMPAK
JEDEC	—
EIAJ	Conforms
Mass (reference value)	0.006 g

Cautions

1. Hitachi neither warrants nor grants licenses of any rights of Hitachi's or any third party's patent, copyright, trademark, or other intellectual property rights for information contained in this document. Hitachi bears no responsibility for problems that may arise with third party's rights, including intellectual property rights, in connection with use of the information contained in this document.
2. Products and product specifications may be subject to change without notice. Confirm that you have received the latest product standards or specifications before final design, purchase or use.
3. Hitachi makes every attempt to ensure that its products are of high quality and reliability. However, contact Hitachi's sales office before using the product in an application that demands especially high quality and reliability or where its failure or malfunction may directly threaten human life or cause risk of bodily injury, such as aerospace, aeronautics, nuclear power, combustion control, transportation, traffic, safety equipment or medical equipment for life support.
4. Design your application so that the product is used within the ranges guaranteed by Hitachi particularly for maximum rating, operating supply voltage range, heat radiation characteristics, installation conditions and other characteristics. Hitachi bears no responsibility for failure or damage when used beyond the guaranteed ranges. Even within the guaranteed ranges, consider normally foreseeable failure rates or failure modes in semiconductor devices and employ systemic measures such as fail-safes, so that the equipment incorporating Hitachi product does not cause bodily injury, fire or other consequential damage due to operation of the Hitachi product.
5. This product is not designed to be radiation resistant.
6. No one is permitted to reproduce or duplicate, in any form, the whole or part of this document without written approval from Hitachi.
7. Contact Hitachi's sales office for any questions regarding this document or Hitachi semiconductor products.

HITACHI

Hitachi, Ltd.

Semiconductor & Integrated Circuits.
 Nippon Bldg., 2-6-2, Ohte-machi, Chiyoda-ku, Tokyo 100-0004, Japan
 Tel: Tokyo (03) 3270-2111 Fax: (03) 3270-5109

URL	NorthAmerica	: http://semiconductor.hitachi.com/
	Europe	: http://www.hitachi-eu.com/hel/ecg
	Asia	: http://sicapac.hitachi-asia.com
	Japan	: http://www.hitachi.co.jp/Sicd/indx.htm

For further information write to:

Hitachi Semiconductor
 (America) Inc.
 179 East Tasman Drive,
 San Jose, CA 95134
 Tel: <1> (408) 433-1990
 Fax: <1> (408) 433-0223

Hitachi Europe GmbH
 Electronic Components Group
 Dornacher Straße 3
 D-85622 Feldkirchen, Munich
 Germany
 Tel: <49> (89) 9 9180-0
 Fax: <49> (89) 9 29 30 00

Hitachi Europe Ltd.
 Electronic Components Group.
 Whitebrook Park
 Lower Cookham Road
 Maidenhead
 Berkshire SL6 8YA, United Kingdom
 Tel: <44> (1628) 585000
 Fax: <44> (1628) 585160

Hitachi Asia Ltd.
 Hitachi Tower
 16 Collyer Quay #20-00,
 Singapore 049318
 Tel : <65>-538-6533/538-8577
 Fax : <65>-538-6933/538-3877
 URL : <http://www.hitachi.com.sg>

Hitachi Asia Ltd.
 (Taipei Branch Office)
 4/F, No. 167, Tun Hwa North Road,
 Hung-Kuo Building,
 Taipei (105), Taiwan
 Tel : <886>-(2)-2718-3666
 Fax : <886>-(2)-2718-8180
 Telex : 23222 HAS-TP
 URL : <http://www.hitachi.com.tw>

Hitachi Asia (Hong Kong) Ltd.
 Group III (Electronic Components)
 7/F., North Tower,
 World Finance Centre,
 Harbour City, Canton Road
 Tsim Sha Tsui, Kowloon,
 Hong Kong
 Tel : <852>-(2)-735-9218
 Fax : <852>-(2)-730-0281
 URL : <http://www.hitachi.com.hk>

Copyright © Hitachi, Ltd., 2000. All rights reserved. Printed in Japan.
 Colophon 2.0



LittleDiode supplies new, hard to find or obsolete electronic components and semiconductors all over the world.

With over two million different components listed you are sure to find the part you need.

Feel free to visit us today at our online store:

LittleDiode.com

Looking forward to providing you with the best possible service.