

2SC5945

Si NPN Epitaxial High Frequency Medium Power Amplifier

REJ03G0443-0100

Rev.1.00

Oct.28.2004

Features

- Excellent Linearity
P1dB at output = +26 dBm typ. f = 2.4 GHz
- High Collector to Emitter Voltage
 $V_{CEO} = 5\text{ V}$
- Ideal for 2 GHz Band applications. e.g 2.4 GHz WLAN, Digital cordless phone.
- 7 Pin, Lead less, Small mounting area (2.0 × 2.0 × 0.8 mm).

Outline

WSON0202-6V

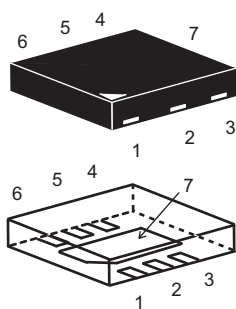

1. Collector
2. Collector
3. Collector
4. Emitter
5. Base
6. Emitter
7. Emitter

Note: Marking is "5945".

Absolute Maximum Ratings

($T_a = 25^\circ\text{C}$)

| Item | Symbol | Ratings | Unit |
|------------------------------|-----------|-------------------|------------------|
| Collector to base voltage | V_{CBO} | 13 | V |
| Collector to emitter voltage | V_{CEO} | 5 | V |
| Emitter to base voltage | V_{EBO} | 1.5 | V |
| Collector current | I_c | 500 | mA |
| Collector power dissipation | P_c | 1 ^{Note} | W |
| Junction temperature | T_j | 150 | $^\circ\text{C}$ |
| Storage temperature | T_{stg} | -55 to +150 | $^\circ\text{C}$ |

Note: Value on PCB (40 x 40 x 1.0 mm)

Electrical Characteristics

(Ta = 25°C)

| Item | Symbol | Min | Typ | Max | Unit | Test Conditions |
|---------------------------------|----------|-----|------|-----|------|--|
| DC current transfer ratio | h_{FE} | 110 | 150 | 190 | — | $V_{CE} = 3\text{ V}$, $I_C = 100\text{ mA}$ |
| Reverse Transfer Capacitance | C_{re} | — | 1.0 | — | pF | $V_{CB} = 2\text{ V}$, $I_E = 0$, $f = 1\text{ MHz}$ emitter grounded |
| Transition Frequency | f_T | — | 15.5 | — | GHz | $V_{CE} = 3\text{ V}$, $I_C = 100\text{ mA}$ $f = 1\text{ GHz}$ |
| Maximum Available Gain | MAG | — | 9 | — | dB | $V_{CE} = 3\text{ V}$, $I_C = 100\text{ mA}$, $f = 2.4\text{ GHz}$, |
| Power Gain | PG | 4 | 6 | — | dB | $V_{CE} = 3.3\text{ V}$, $I_{Cq} = 100\text{ mA}$, $f = 2.4\text{ GHz}$, $P_{in} = +20\text{ dBm}$ |
| Added Power Efficiency | PAE | 30 | 40 | — | % | $V_{CE} = 3.3\text{ V}$, $I_{Cq} = 100\text{ mA}$, $f = 2.4\text{ GHz}$ |
| 1dB Compression Point at output | P1dB | — | +24 | — | dBm | $V_{CE} = 3.3\text{ V}$, $I_{Cq} = 100\text{ mA}$, $f = 2.4\text{ GHz}$ |
| 1dB Compression Point at output | P1dB | — | +26 | — | dBm | $V_{CE} = 3.3\text{ V}$, $I_{Cq} = 250\text{ mA}$, $f = 2.4\text{ GHz}$ |

Main Characteristics

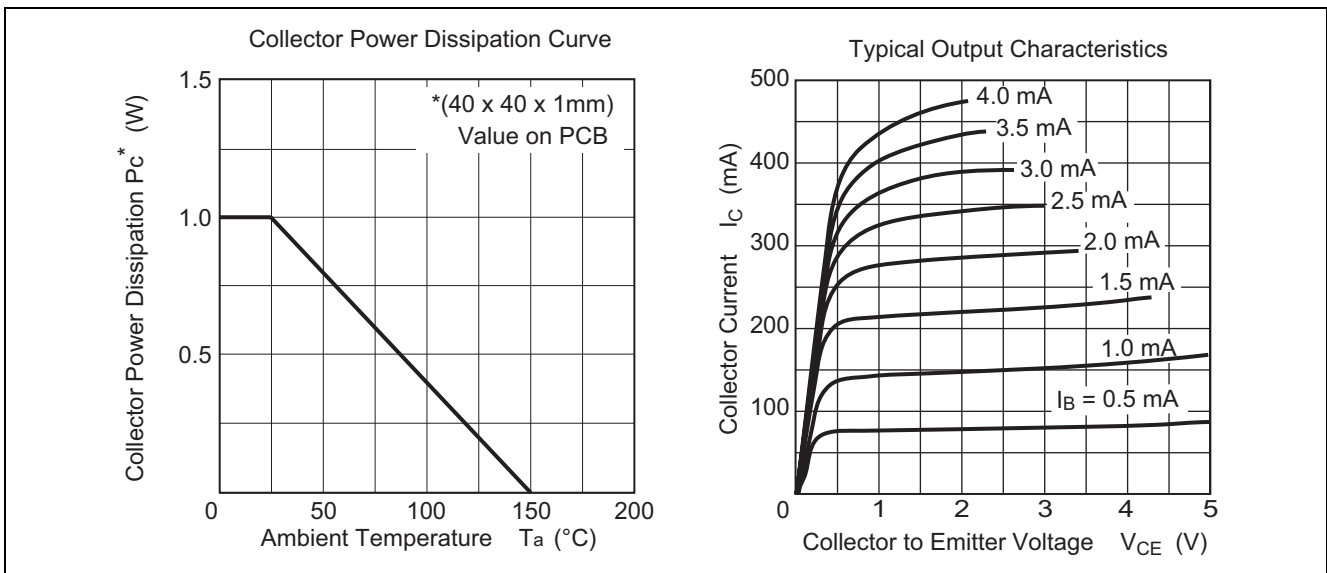

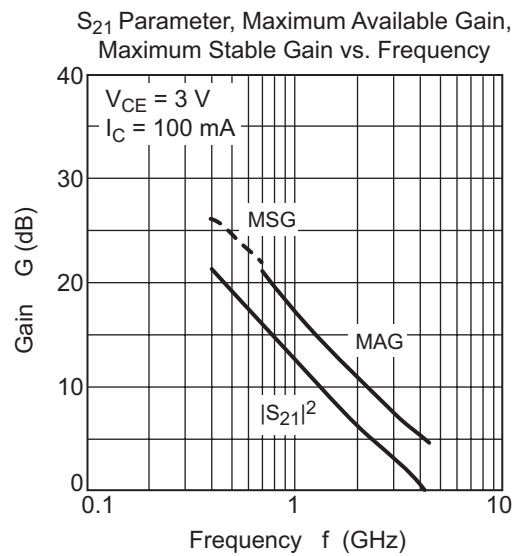
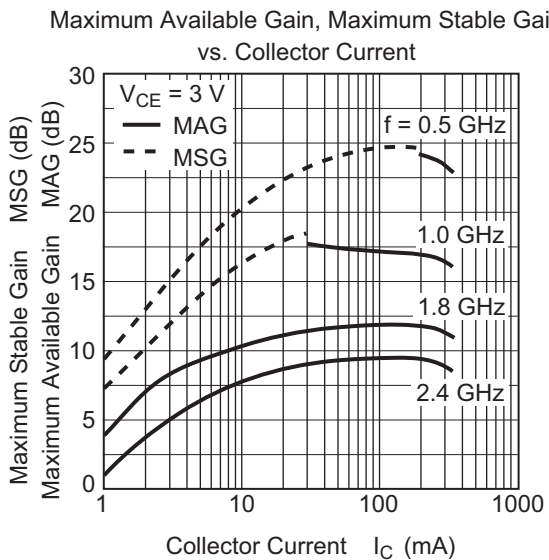
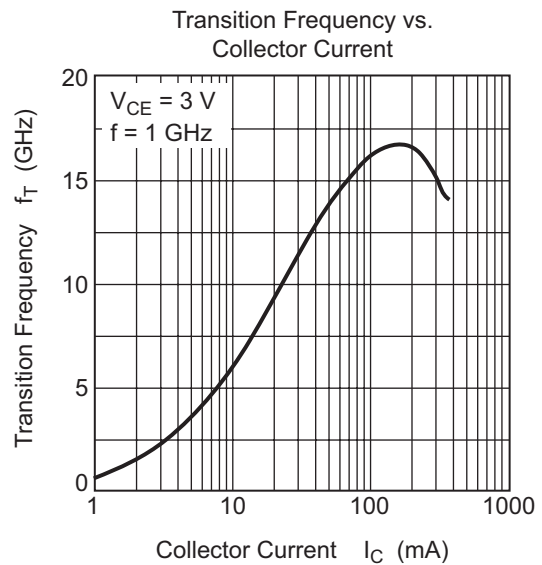
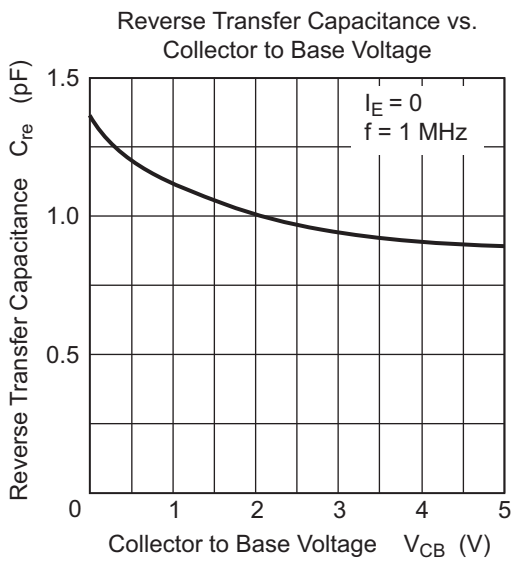
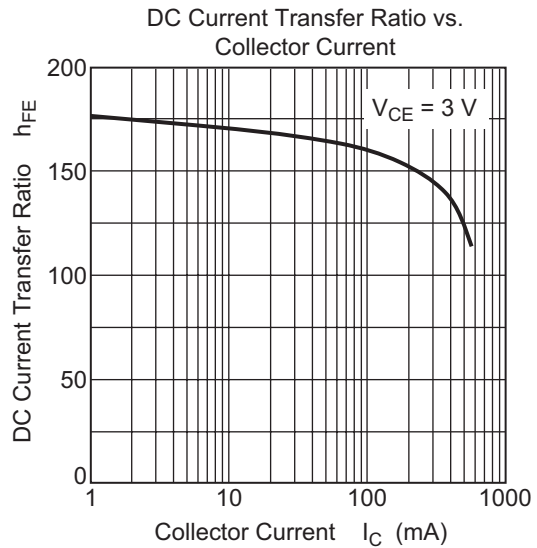
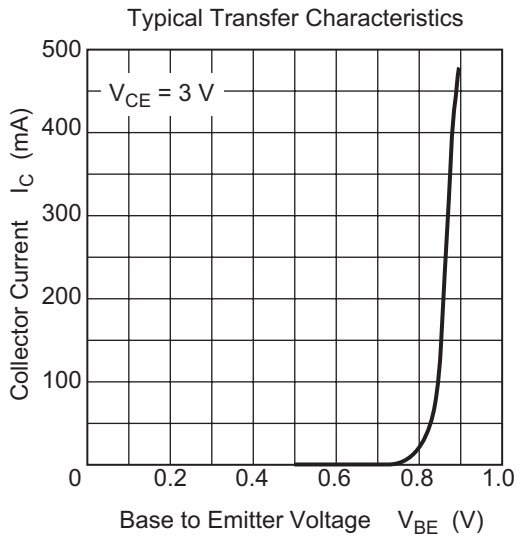

Pin-Pout Characteristics

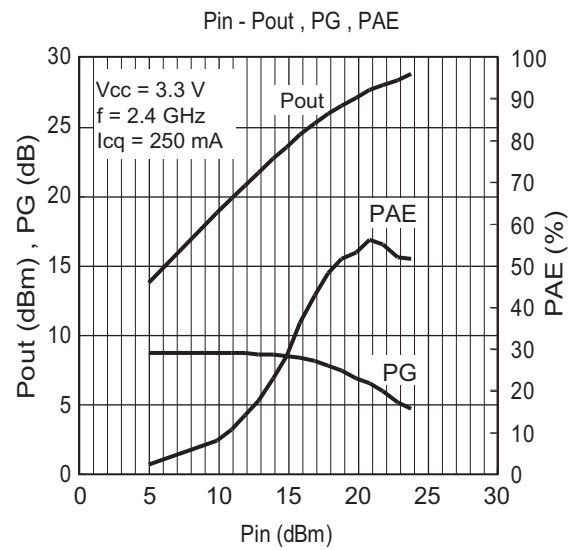
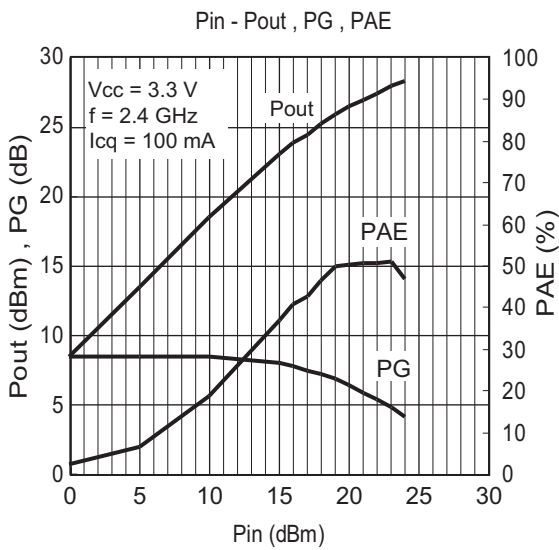
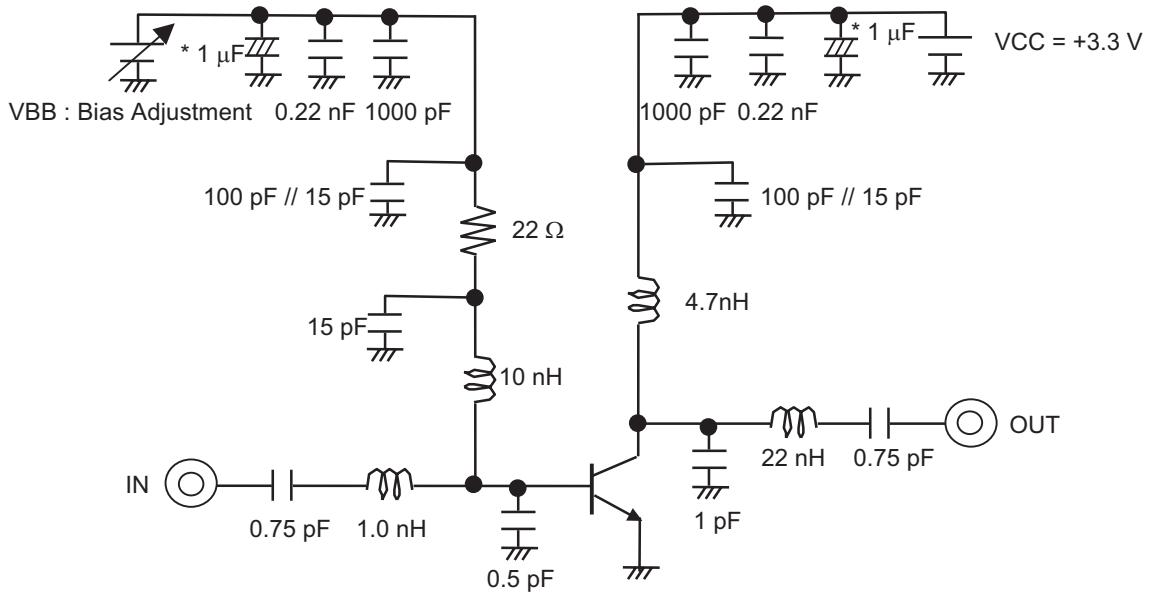

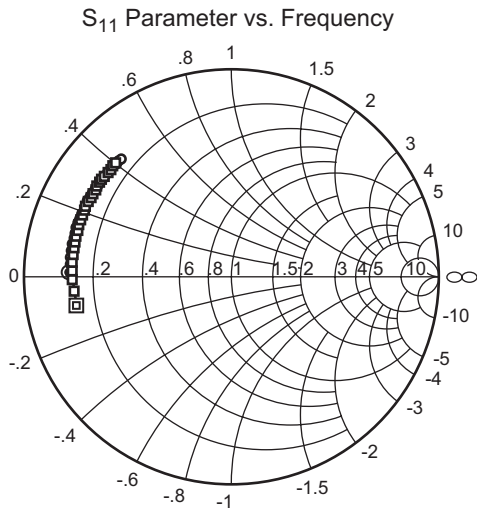

Condition: $V_{CE} = 3\text{ V}$, $Z_0 = 50\ \Omega$
 400 to 3000 MHz (100 MHz Step)
 ○ ($I_C = 100\text{ mA}$)
 □ ($I_C = 250\text{ mA}$)

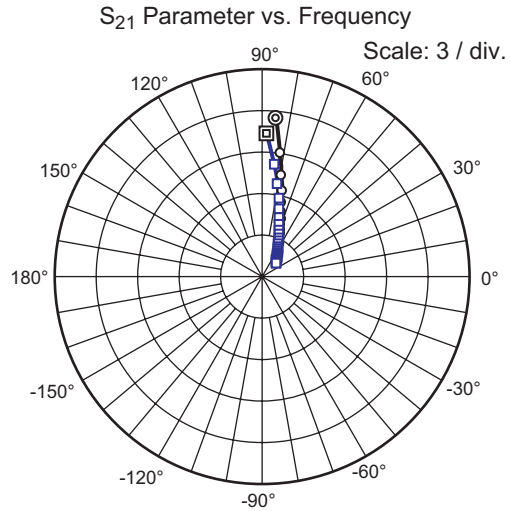

Condition: $V_{CE} = 3\text{ V}$, $Z_0 = 50\ \Omega$
 400 to 3000 MHz (100 MHz Step)
 ○ ($I_C = 100\text{ mA}$)
 □ ($I_C = 250\text{ mA}$)

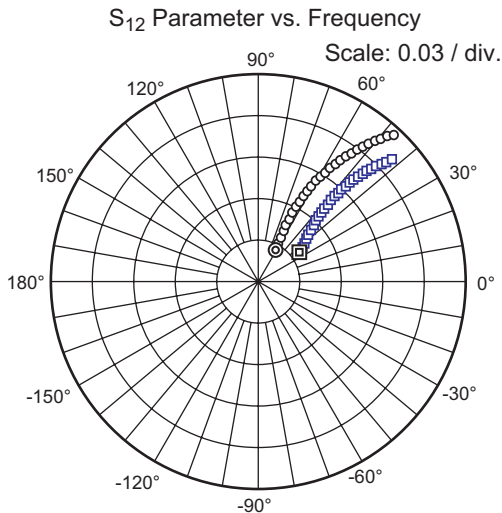

Condition: $V_{CE} = 3\text{ V}$, $Z_0 = 50\ \Omega$
 400 to 3000 MHz (100 MHz Step)
 ○ ($I_C = 100\text{ mA}$)
 □ ($I_C = 250\text{ mA}$)

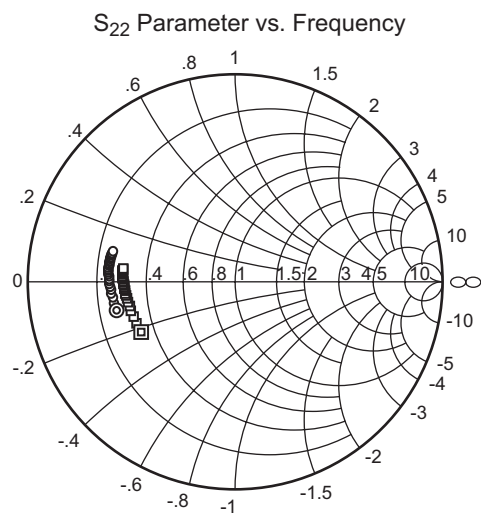

Condition: $V_{CE} = 3\text{ V}$, $Z_0 = 50\ \Omega$
 400 to 3000 MHz (100 MHz Step)
 ○ ($I_C = 100\text{ mA}$)
 □ ($I_C = 250\text{ mA}$)

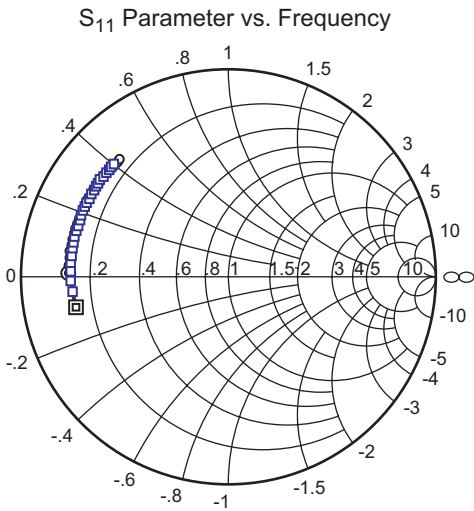

Condition: $V_{CE} = 3.3\text{ V}$, $Z_o = 50\ \Omega$
 400 to 3000 MHz (100 MHz Step)
 ○ ($I_C = 100\text{ mA}$)
 □ ($I_C = 250\text{ mA}$)

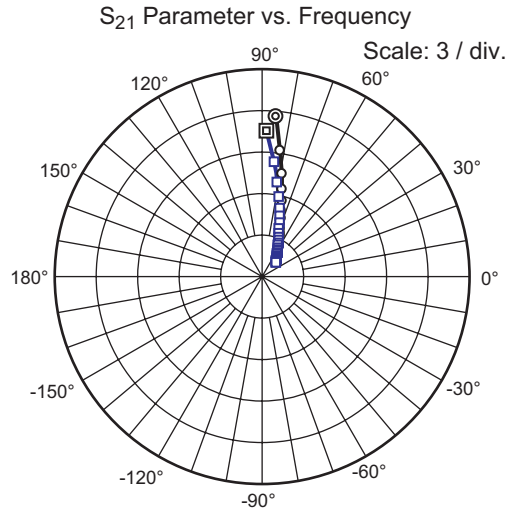

Condition: $V_{CE} = 3.3\text{ V}$, $Z_o = 50\ \Omega$
 400 to 3000 MHz (100 MHz Step)
 ○ ($I_C = 100\text{ mA}$)
 □ ($I_C = 250\text{ mA}$)

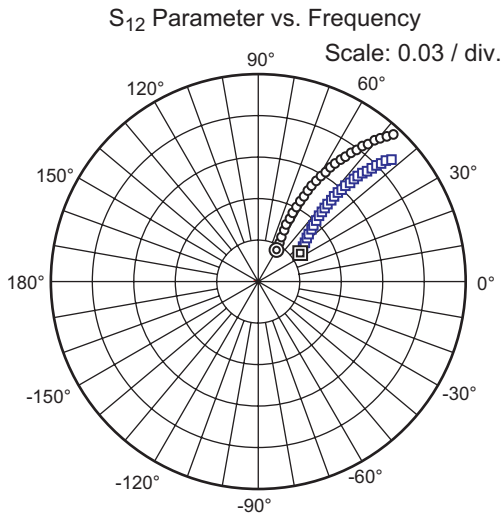

Condition: $V_{CE} = 3.3\text{ V}$, $Z_o = 50\ \Omega$
 400 to 3000 MHz (100 MHz Step)
 ○ ($I_C = 100\text{ mA}$)
 □ ($I_C = 250\text{ mA}$)

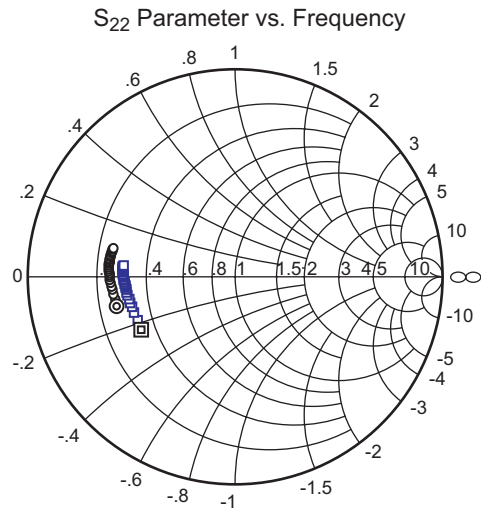

Condition: $V_{CE} = 3.3\text{ V}$, $Z_o = 50\ \Omega$
 400 to 3000 MHz (100 MHz Step)
 ○ ($I_C = 100\text{ mA}$)
 □ ($I_C = 250\text{ mA}$)

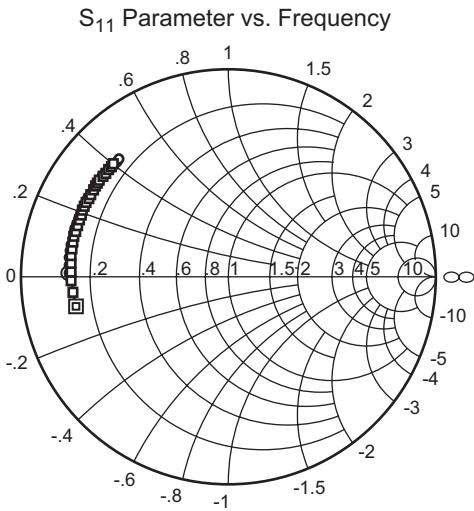

Condition: $V_{CE} = 3.6\text{ V}$, $Z_0 = 50\ \Omega$
 400 to 3000 MHz (100 MHz Step)
 ○ ($I_C = 100\text{ mA}$)
 □ ($I_C = 250\text{ mA}$)

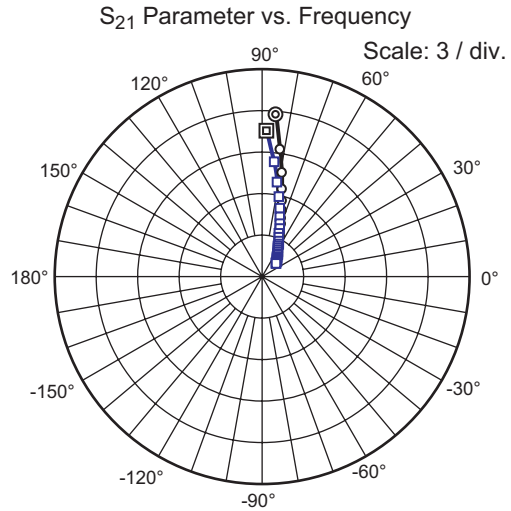

Condition: $V_{CE} = 3.6\text{ V}$, $Z_0 = 50\ \Omega$
 400 to 3000 MHz (100 MHz Step)
 ○ ($I_C = 100\text{ mA}$)
 □ ($I_C = 250\text{ mA}$)

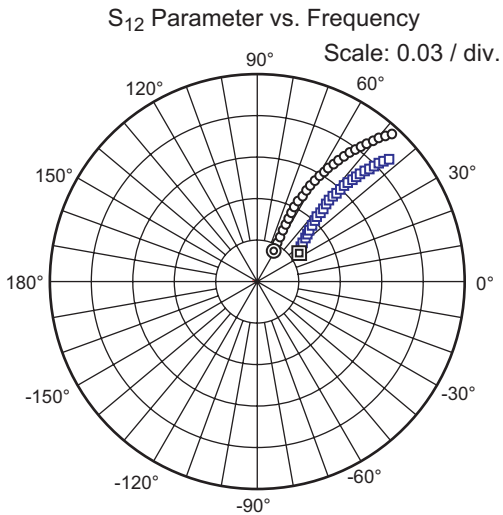

Condition: $V_{CE} = 3.6\text{ V}$, $Z_0 = 50\ \Omega$
 400 to 3000 MHz (100 MHz Step)
 ○ ($I_C = 100\text{ mA}$)
 □ ($I_C = 250\text{ mA}$)

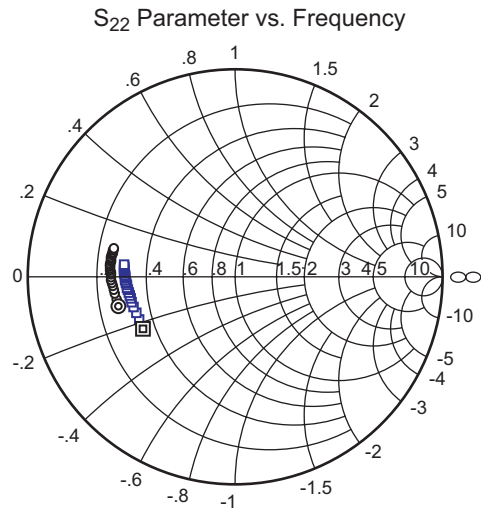

Condition: $V_{CE} = 3.6\text{ V}$, $Z_0 = 50\ \Omega$
 400 to 3000 MHz (100 MHz Step)
 ○ ($I_C = 100\text{ mA}$)
 □ ($I_C = 250\text{ mA}$)

S parameter

 $(V_{CE} = 3 \text{ V}, I_C = 10 \text{ mA}, Z_o = 50 \Omega)$

| f (MHz) | S11 | | S21 | | S12 | | S22 | |
|---------|-------|--------|------|------|-------|------|-------|--------|
| | MAG | ANG | MAG | ANG | MAG | ANG | MAG | ANG |
| 400 | 0.748 | -149.1 | 7.99 | 94.1 | 0.061 | 23.0 | 0.475 | -124.4 |
| 500 | 0.751 | -158.6 | 6.48 | 88.1 | 0.063 | 22.1 | 0.457 | -133.2 |
| 600 | 0.755 | -165.6 | 5.42 | 83.5 | 0.064 | 21.5 | 0.449 | -139.7 |
| 700 | 0.758 | -170.8 | 4.63 | 79.8 | 0.065 | 21.8 | 0.445 | -144.6 |
| 800 | 0.760 | -175.2 | 4.02 | 76.6 | 0.066 | 22.1 | 0.443 | -148.6 |
| 900 | 0.762 | -178.9 | 3.55 | 73.8 | 0.067 | 22.7 | 0.443 | -151.8 |
| 1000 | 0.765 | 177.8 | 3.17 | 71.3 | 0.068 | 23.5 | 0.444 | -154.5 |
| 1100 | 0.768 | 174.9 | 2.87 | 69.0 | 0.070 | 24.6 | 0.446 | -156.8 |
| 1200 | 0.770 | 172.1 | 2.62 | 66.7 | 0.071 | 25.5 | 0.447 | -158.7 |
| 1300 | 0.771 | 169.7 | 2.41 | 64.5 | 0.073 | 26.1 | 0.449 | -160.4 |
| 1400 | 0.772 | 167.2 | 2.23 | 62.4 | 0.074 | 27.2 | 0.452 | -161.8 |
| 1500 | 0.774 | 164.8 | 2.07 | 60.4 | 0.076 | 27.9 | 0.454 | -163.1 |
| 1600 | 0.776 | 162.7 | 1.94 | 58.5 | 0.077 | 29.0 | 0.456 | -164.2 |
| 1700 | 0.780 | 160.7 | 1.82 | 56.7 | 0.079 | 29.7 | 0.459 | -165.2 |
| 1800 | 0.781 | 158.9 | 1.71 | 54.8 | 0.081 | 30.3 | 0.462 | -166.1 |
| 1900 | 0.781 | 157.1 | 1.62 | 52.9 | 0.083 | 31.1 | 0.465 | -166.9 |
| 2000 | 0.781 | 155.1 | 1.54 | 51.1 | 0.085 | 31.6 | 0.468 | -167.6 |
| 2100 | 0.782 | 153.2 | 1.47 | 49.3 | 0.088 | 32.1 | 0.470 | -168.3 |
| 2200 | 0.784 | 151.4 | 1.40 | 47.5 | 0.090 | 32.7 | 0.473 | -168.9 |
| 2300 | 0.788 | 149.8 | 1.34 | 46.0 | 0.092 | 33.1 | 0.476 | -169.5 |
| 2400 | 0.790 | 148.3 | 1.28 | 44.3 | 0.095 | 33.4 | 0.478 | -170.1 |
| 2500 | 0.791 | 146.8 | 1.23 | 42.7 | 0.097 | 33.8 | 0.481 | -170.6 |
| 2600 | 0.789 | 145.1 | 1.18 | 40.9 | 0.100 | 33.9 | 0.483 | -171.1 |
| 2700 | 0.789 | 143.3 | 1.14 | 39.2 | 0.102 | 34.2 | 0.486 | -171.7 |
| 2800 | 0.790 | 141.6 | 1.10 | 37.5 | 0.105 | 34.4 | 0.488 | -172.2 |
| 2900 | 0.793 | 140.1 | 1.07 | 36.1 | 0.108 | 34.4 | 0.491 | -172.7 |
| 3000 | 0.795 | 138.7 | 1.03 | 34.5 | 0.111 | 34.3 | 0.493 | -173.3 |

S parameter

 $(V_{CE} = 3 \text{ V}, I_C = 20 \text{ mA}, Z_o = 50 \Omega)$

| f (MHz) | S11 | | S21 | | S12 | | S22 | |
|---------|-------|--------|------|------|-------|------|-------|--------|
| | MAG | ANG | MAG | ANG | MAG | ANG | MAG | ANG |
| 400 | 0.750 | -165.7 | 9.73 | 89.3 | 0.042 | 31.0 | 0.505 | -146.0 |
| 500 | 0.754 | -171.7 | 7.74 | 84.8 | 0.044 | 33.1 | 0.501 | -152.5 |
| 600 | 0.758 | -176.3 | 6.39 | 81.3 | 0.046 | 34.3 | 0.501 | -157.1 |
| 700 | 0.761 | 180.0 | 5.43 | 78.4 | 0.049 | 36.2 | 0.503 | -160.6 |
| 800 | 0.762 | 176.7 | 4.70 | 75.8 | 0.052 | 37.5 | 0.504 | -163.5 |
| 900 | 0.763 | 173.8 | 4.14 | 73.5 | 0.055 | 38.8 | 0.506 | -165.8 |
| 1000 | 0.766 | 171.2 | 3.69 | 71.5 | 0.058 | 40.2 | 0.508 | -167.8 |
| 1100 | 0.768 | 168.8 | 3.34 | 69.6 | 0.061 | 41.5 | 0.510 | -169.5 |
| 1200 | 0.768 | 166.5 | 3.04 | 67.6 | 0.064 | 42.3 | 0.512 | -171.0 |
| 1300 | 0.769 | 164.4 | 2.80 | 65.8 | 0.067 | 42.8 | 0.513 | -172.3 |
| 1400 | 0.769 | 162.2 | 2.59 | 64.0 | 0.071 | 43.5 | 0.515 | -173.4 |
| 1500 | 0.770 | 160.1 | 2.41 | 62.2 | 0.074 | 43.8 | 0.516 | -174.5 |
| 1600 | 0.772 | 158.2 | 2.26 | 60.6 | 0.078 | 44.2 | 0.518 | -175.5 |
| 1700 | 0.775 | 156.5 | 2.12 | 58.9 | 0.081 | 44.4 | 0.519 | -176.3 |
| 1800 | 0.775 | 154.9 | 2.00 | 57.3 | 0.084 | 44.4 | 0.521 | -177.1 |
| 1900 | 0.775 | 153.2 | 1.89 | 55.6 | 0.087 | 44.6 | 0.522 | -177.8 |
| 2000 | 0.774 | 151.4 | 1.80 | 53.9 | 0.091 | 44.4 | 0.523 | -178.4 |
| 2100 | 0.774 | 149.6 | 1.71 | 52.3 | 0.095 | 44.2 | 0.524 | -179.0 |
| 2200 | 0.776 | 148.0 | 1.64 | 50.7 | 0.098 | 43.9 | 0.525 | -179.7 |
| 2300 | 0.778 | 146.4 | 1.57 | 49.3 | 0.101 | 43.8 | 0.526 | 179.7 |
| 2400 | 0.780 | 145.0 | 1.50 | 47.8 | 0.105 | 43.4 | 0.527 | 179.2 |
| 2500 | 0.780 | 143.6 | 1.44 | 46.3 | 0.108 | 43.1 | 0.527 | 178.7 |
| 2600 | 0.778 | 142.0 | 1.39 | 44.6 | 0.112 | 42.6 | 0.528 | 178.1 |
| 2700 | 0.777 | 140.3 | 1.34 | 43.0 | 0.115 | 42.3 | 0.528 | 177.6 |
| 2800 | 0.777 | 138.7 | 1.30 | 41.4 | 0.119 | 41.8 | 0.529 | 177.1 |
| 2900 | 0.779 | 137.3 | 1.26 | 40.0 | 0.123 | 41.3 | 0.530 | 176.5 |
| 3000 | 0.781 | 136.0 | 1.22 | 38.6 | 0.126 | 40.7 | 0.530 | 176.0 |

S parameter

 $(V_{CE} = 3 \text{ V}, I_C = 30 \text{ mA}, Z_o = 50 \Omega)$

| f (MHz) | S11 | | S21 | | S12 | | S22 | |
|---------|-------|--------|-------|------|-------|------|-------|--------|
| | MAG | ANG | MAG | ANG | MAG | ANG | MAG | ANG |
| 400 | 0.755 | -172.0 | 10.39 | 87.5 | 0.035 | 38.2 | 0.531 | -154.4 |
| 500 | 0.759 | -176.8 | 8.22 | 83.6 | 0.038 | 41.0 | 0.531 | -159.7 |
| 600 | 0.763 | 179.5 | 6.78 | 80.5 | 0.041 | 42.9 | 0.534 | -163.4 |
| 700 | 0.764 | 176.3 | 5.75 | 77.9 | 0.045 | 45.1 | 0.536 | -166.3 |
| 800 | 0.766 | 173.4 | 4.98 | 75.5 | 0.048 | 46.5 | 0.538 | -168.7 |
| 900 | 0.766 | 170.8 | 4.39 | 73.5 | 0.052 | 47.5 | 0.540 | -170.7 |
| 1000 | 0.768 | 168.4 | 3.91 | 71.6 | 0.056 | 48.7 | 0.543 | -172.4 |
| 1100 | 0.770 | 166.3 | 3.54 | 69.9 | 0.060 | 49.6 | 0.544 | -173.9 |
| 1200 | 0.770 | 164.2 | 3.22 | 68.1 | 0.063 | 50.1 | 0.546 | -175.2 |
| 1300 | 0.770 | 162.2 | 2.97 | 66.4 | 0.067 | 50.2 | 0.547 | -176.4 |
| 1400 | 0.770 | 160.2 | 2.75 | 64.7 | 0.071 | 50.4 | 0.549 | -177.5 |
| 1500 | 0.771 | 158.2 | 2.56 | 63.0 | 0.075 | 50.3 | 0.550 | -178.5 |
| 1600 | 0.772 | 156.4 | 2.39 | 61.5 | 0.079 | 50.4 | 0.551 | -179.4 |
| 1700 | 0.774 | 154.7 | 2.25 | 60.0 | 0.083 | 50.3 | 0.552 | 179.9 |
| 1800 | 0.775 | 153.2 | 2.12 | 58.4 | 0.087 | 49.8 | 0.554 | 179.1 |
| 1900 | 0.774 | 151.5 | 2.01 | 56.8 | 0.090 | 49.7 | 0.554 | 178.4 |
| 2000 | 0.773 | 149.8 | 1.91 | 55.2 | 0.094 | 49.3 | 0.555 | 177.8 |
| 2100 | 0.773 | 148.1 | 1.82 | 53.6 | 0.098 | 48.8 | 0.555 | 177.1 |
| 2200 | 0.774 | 146.5 | 1.74 | 52.1 | 0.102 | 48.3 | 0.556 | 176.5 |
| 2300 | 0.776 | 145.0 | 1.67 | 50.7 | 0.106 | 47.8 | 0.556 | 175.9 |
| 2400 | 0.777 | 143.6 | 1.60 | 49.3 | 0.110 | 47.2 | 0.556 | 175.4 |
| 2500 | 0.777 | 142.2 | 1.54 | 47.9 | 0.114 | 46.7 | 0.556 | 174.8 |
| 2600 | 0.775 | 140.7 | 1.48 | 46.3 | 0.117 | 45.9 | 0.556 | 174.3 |
| 2700 | 0.774 | 139.0 | 1.43 | 44.7 | 0.121 | 45.4 | 0.556 | 173.7 |
| 2800 | 0.774 | 137.4 | 1.38 | 43.1 | 0.125 | 44.7 | 0.556 | 173.1 |
| 2900 | 0.775 | 136.1 | 1.34 | 41.8 | 0.129 | 44.0 | 0.556 | 172.6 |
| 3000 | 0.776 | 134.7 | 1.30 | 40.4 | 0.133 | 43.2 | 0.556 | 172.0 |

S parameter

 $(V_{CE} = 3 \text{ V}, I_C = 50 \text{ mA}, Z_o = 50 \Omega)$

| f (MHz) | S11 | | S21 | | S12 | | S22 | |
|---------|-------|--------|-------|------|-------|------|-------|--------|
| | MAG | ANG | MAG | ANG | MAG | ANG | MAG | ANG |
| 400 | 0.762 | -177.4 | 10.93 | 86.0 | 0.029 | 48.2 | 0.561 | -161.3 |
| 500 | 0.765 | 178.9 | 8.64 | 82.6 | 0.033 | 51.2 | 0.564 | -165.5 |
| 600 | 0.768 | 175.9 | 7.11 | 79.8 | 0.037 | 53.0 | 0.567 | -168.5 |
| 700 | 0.770 | 173.1 | 6.03 | 77.5 | 0.042 | 54.7 | 0.570 | -170.9 |
| 800 | 0.770 | 170.6 | 5.22 | 75.4 | 0.046 | 55.4 | 0.573 | -172.9 |
| 900 | 0.770 | 168.3 | 4.60 | 73.5 | 0.050 | 56.2 | 0.575 | -174.6 |
| 1000 | 0.772 | 166.1 | 4.10 | 71.8 | 0.055 | 56.7 | 0.577 | -176.1 |
| 1100 | 0.773 | 164.1 | 3.71 | 70.2 | 0.059 | 57.0 | 0.579 | -177.4 |
| 1200 | 0.773 | 162.2 | 3.38 | 68.6 | 0.063 | 56.9 | 0.580 | -178.6 |
| 1300 | 0.772 | 160.3 | 3.11 | 67.0 | 0.068 | 56.5 | 0.581 | -179.7 |
| 1400 | 0.772 | 158.4 | 2.89 | 65.3 | 0.072 | 56.5 | 0.582 | 179.4 |
| 1500 | 0.772 | 156.5 | 2.69 | 63.8 | 0.077 | 56.1 | 0.584 | 178.4 |
| 1600 | 0.774 | 154.7 | 2.52 | 62.3 | 0.081 | 55.8 | 0.585 | 177.6 |
| 1700 | 0.776 | 153.1 | 2.36 | 60.9 | 0.085 | 55.3 | 0.585 | 176.8 |
| 1800 | 0.775 | 151.6 | 2.23 | 59.5 | 0.089 | 54.5 | 0.586 | 176.1 |
| 1900 | 0.775 | 150.1 | 2.11 | 57.9 | 0.094 | 54.1 | 0.586 | 175.4 |
| 2000 | 0.773 | 148.4 | 2.01 | 56.4 | 0.098 | 53.4 | 0.586 | 174.8 |
| 2100 | 0.772 | 146.7 | 1.92 | 54.8 | 0.102 | 52.6 | 0.586 | 174.1 |
| 2200 | 0.773 | 145.1 | 1.83 | 53.4 | 0.106 | 52.0 | 0.586 | 173.5 |
| 2300 | 0.776 | 143.7 | 1.75 | 52.1 | 0.110 | 51.2 | 0.586 | 172.9 |
| 2400 | 0.776 | 142.4 | 1.68 | 50.7 | 0.114 | 50.4 | 0.586 | 172.3 |
| 2500 | 0.776 | 141.0 | 1.62 | 49.3 | 0.119 | 49.7 | 0.586 | 171.7 |
| 2600 | 0.774 | 139.4 | 1.56 | 47.8 | 0.122 | 48.7 | 0.585 | 171.2 |
| 2700 | 0.772 | 137.8 | 1.51 | 46.3 | 0.127 | 48.0 | 0.585 | 170.6 |
| 2800 | 0.772 | 136.3 | 1.46 | 44.8 | 0.131 | 47.2 | 0.584 | 170.0 |
| 2900 | 0.773 | 134.9 | 1.41 | 43.4 | 0.135 | 46.2 | 0.584 | 169.4 |
| 3000 | 0.774 | 133.6 | 1.37 | 42.1 | 0.139 | 45.3 | 0.583 | 168.8 |

S parameter

 $(V_{CE} = 3 \text{ V}, I_C = 70 \text{ mA}, Z_o = 50 \Omega)$

| f (MHz) | S11 | | S21 | | S12 | | S22 | |
|---------|-------|--------|-------|------|-------|------|-------|--------|
| | MAG | ANG | MAG | ANG | MAG | ANG | MAG | ANG |
| 400 | 0.767 | -179.7 | 11.15 | 85.3 | 0.027 | 54.1 | 0.576 | -164.2 |
| 500 | 0.769 | 177.0 | 8.80 | 82.2 | 0.032 | 56.7 | 0.580 | -167.9 |
| 600 | 0.772 | 174.3 | 7.24 | 79.6 | 0.036 | 58.8 | 0.584 | -170.7 |
| 700 | 0.773 | 171.7 | 6.14 | 77.4 | 0.041 | 59.5 | 0.587 | -172.8 |
| 800 | 0.773 | 169.3 | 5.32 | 75.4 | 0.045 | 59.9 | 0.589 | -174.7 |
| 900 | 0.773 | 167.1 | 4.69 | 73.6 | 0.050 | 60.1 | 0.591 | -176.3 |
| 1000 | 0.774 | 165.0 | 4.18 | 72.0 | 0.055 | 60.4 | 0.594 | -177.7 |
| 1100 | 0.775 | 163.1 | 3.78 | 70.4 | 0.060 | 60.7 | 0.595 | -178.9 |
| 1200 | 0.775 | 161.3 | 3.45 | 68.8 | 0.064 | 60.1 | 0.597 | 180.0 |
| 1300 | 0.774 | 159.4 | 3.18 | 67.3 | 0.069 | 59.5 | 0.597 | 179.0 |
| 1400 | 0.774 | 157.6 | 2.95 | 65.7 | 0.073 | 59.2 | 0.599 | 178.0 |
| 1500 | 0.774 | 155.7 | 2.74 | 64.2 | 0.078 | 58.6 | 0.600 | 177.1 |
| 1600 | 0.775 | 154.0 | 2.57 | 62.8 | 0.082 | 58.0 | 0.600 | 176.3 |
| 1700 | 0.777 | 152.4 | 2.42 | 61.4 | 0.087 | 57.4 | 0.601 | 175.6 |
| 1800 | 0.776 | 150.9 | 2.28 | 60.0 | 0.091 | 56.7 | 0.601 | 174.9 |
| 1900 | 0.776 | 149.4 | 2.16 | 58.5 | 0.095 | 56.0 | 0.602 | 174.2 |
| 2000 | 0.773 | 147.7 | 2.05 | 57.0 | 0.099 | 55.2 | 0.602 | 173.5 |
| 2100 | 0.773 | 146.1 | 1.96 | 55.5 | 0.104 | 54.4 | 0.601 | 172.9 |
| 2200 | 0.774 | 144.5 | 1.87 | 54.1 | 0.108 | 53.6 | 0.601 | 172.2 |
| 2300 | 0.776 | 143.1 | 1.79 | 52.8 | 0.112 | 52.8 | 0.601 | 171.6 |
| 2400 | 0.776 | 141.8 | 1.72 | 51.4 | 0.117 | 51.9 | 0.601 | 171.1 |
| 2500 | 0.776 | 140.4 | 1.66 | 50.1 | 0.121 | 51.0 | 0.600 | 170.5 |
| 2600 | 0.773 | 138.9 | 1.60 | 48.5 | 0.125 | 50.0 | 0.599 | 169.9 |
| 2700 | 0.772 | 137.3 | 1.54 | 47.0 | 0.129 | 49.2 | 0.599 | 169.3 |
| 2800 | 0.771 | 135.7 | 1.49 | 45.5 | 0.133 | 48.2 | 0.598 | 168.7 |
| 2900 | 0.773 | 134.4 | 1.45 | 44.2 | 0.138 | 47.4 | 0.597 | 168.1 |
| 3000 | 0.773 | 133.1 | 1.40 | 42.9 | 0.142 | 46.3 | 0.597 | 167.5 |

S parameter

(V_{CE} = 3 V, I_C = 100 mA, Z_o = 50 Ω)

| f (MHz) | S11 | | S21 | | S12 | | S22 | |
|---------|-------|-------|-------|------|-------|------|-------|--------|
| | MAG | ANG | MAG | ANG | MAG | ANG | MAG | ANG |
| 400 | 0.771 | 178.5 | 11.27 | 84.9 | 0.026 | 59.9 | 0.588 | -166.4 |
| 500 | 0.773 | 175.5 | 8.90 | 81.9 | 0.031 | 62.2 | 0.592 | -169.7 |
| 600 | 0.775 | 173.0 | 7.32 | 79.4 | 0.035 | 63.0 | 0.596 | -172.2 |
| 700 | 0.776 | 170.6 | 6.21 | 77.3 | 0.040 | 63.2 | 0.599 | -174.2 |
| 800 | 0.776 | 168.3 | 5.38 | 75.4 | 0.045 | 63.7 | 0.602 | -176.0 |
| 900 | 0.776 | 166.2 | 4.74 | 73.7 | 0.050 | 63.4 | 0.604 | -177.5 |
| 1000 | 0.776 | 164.2 | 4.23 | 72.1 | 0.055 | 63.3 | 0.606 | -178.8 |
| 1100 | 0.777 | 162.4 | 3.83 | 70.6 | 0.060 | 63.1 | 0.608 | -180.0 |
| 1200 | 0.777 | 160.6 | 3.49 | 69.1 | 0.064 | 62.4 | 0.609 | 178.9 |
| 1300 | 0.776 | 158.8 | 3.22 | 67.6 | 0.069 | 62.0 | 0.610 | 178.0 |
| 1400 | 0.776 | 156.9 | 2.99 | 66.0 | 0.074 | 61.3 | 0.611 | 177.0 |
| 1500 | 0.776 | 155.1 | 2.78 | 64.5 | 0.078 | 60.7 | 0.612 | 176.2 |
| 1600 | 0.777 | 153.4 | 2.60 | 63.2 | 0.083 | 60.0 | 0.612 | 175.4 |
| 1700 | 0.779 | 151.8 | 2.45 | 61.8 | 0.088 | 59.2 | 0.613 | 174.7 |
| 1800 | 0.778 | 150.4 | 2.31 | 60.4 | 0.092 | 58.3 | 0.613 | 173.9 |
| 1900 | 0.777 | 148.9 | 2.19 | 58.9 | 0.096 | 57.6 | 0.613 | 173.2 |
| 2000 | 0.775 | 147.2 | 2.08 | 57.4 | 0.101 | 56.6 | 0.613 | 172.6 |
| 2100 | 0.775 | 145.6 | 1.99 | 56.0 | 0.105 | 55.7 | 0.613 | 172.0 |
| 2200 | 0.775 | 144.0 | 1.90 | 54.6 | 0.110 | 54.9 | 0.613 | 171.3 |
| 2300 | 0.777 | 142.6 | 1.82 | 53.3 | 0.114 | 53.9 | 0.612 | 170.7 |
| 2400 | 0.778 | 141.3 | 1.75 | 52.0 | 0.118 | 53.0 | 0.612 | 170.1 |
| 2500 | 0.777 | 139.9 | 1.68 | 50.6 | 0.123 | 52.1 | 0.611 | 169.6 |
| 2600 | 0.774 | 138.4 | 1.62 | 49.1 | 0.127 | 51.1 | 0.610 | 168.9 |
| 2700 | 0.773 | 136.8 | 1.57 | 47.6 | 0.131 | 50.1 | 0.610 | 168.3 |
| 2800 | 0.772 | 135.3 | 1.51 | 46.1 | 0.135 | 49.3 | 0.609 | 167.7 |
| 2900 | 0.773 | 133.9 | 1.47 | 44.9 | 0.140 | 48.2 | 0.608 | 167.1 |
| 3000 | 0.774 | 132.6 | 1.43 | 43.5 | 0.144 | 47.1 | 0.607 | 166.5 |

S parameter

(V_{CE} = 3 V, I_C = 150 mA, Z_o = 50 Ω)

| f (MHz) | S11 | | S21 | | S12 | | S22 | |
|---------|-------|-------|-------|------|-------|------|-------|--------|
| | MAG | ANG | MAG | ANG | MAG | ANG | MAG | ANG |
| 400 | 0.776 | 177.0 | 11.25 | 84.6 | 0.025 | 64.8 | 0.597 | -168.1 |
| 500 | 0.777 | 174.3 | 8.88 | 81.7 | 0.030 | 65.7 | 0.602 | -171.1 |
| 600 | 0.780 | 172.0 | 7.30 | 79.4 | 0.035 | 66.7 | 0.606 | -173.4 |
| 700 | 0.780 | 169.7 | 6.20 | 77.3 | 0.040 | 66.5 | 0.609 | -175.3 |
| 800 | 0.780 | 167.5 | 5.38 | 75.5 | 0.045 | 66.3 | 0.611 | -177.0 |
| 900 | 0.779 | 165.5 | 4.74 | 73.8 | 0.050 | 66.1 | 0.613 | -178.4 |
| 1000 | 0.780 | 163.5 | 4.23 | 72.3 | 0.055 | 65.8 | 0.615 | -179.7 |
| 1100 | 0.781 | 161.8 | 3.83 | 70.9 | 0.060 | 65.3 | 0.617 | 179.2 |
| 1200 | 0.781 | 160.0 | 3.50 | 69.3 | 0.065 | 64.4 | 0.618 | 178.1 |
| 1300 | 0.780 | 158.2 | 3.22 | 67.9 | 0.069 | 63.7 | 0.619 | 177.2 |
| 1400 | 0.779 | 156.4 | 2.99 | 66.3 | 0.074 | 63.0 | 0.620 | 176.3 |
| 1500 | 0.779 | 154.6 | 2.79 | 64.9 | 0.079 | 62.2 | 0.620 | 175.4 |
| 1600 | 0.780 | 152.9 | 2.61 | 63.5 | 0.084 | 61.6 | 0.621 | 174.7 |
| 1700 | 0.782 | 151.4 | 2.46 | 62.2 | 0.088 | 60.6 | 0.622 | 173.9 |
| 1800 | 0.781 | 150.0 | 2.32 | 60.7 | 0.093 | 59.6 | 0.622 | 173.2 |
| 1900 | 0.780 | 148.4 | 2.20 | 59.3 | 0.097 | 58.9 | 0.621 | 172.5 |
| 2000 | 0.778 | 146.8 | 2.09 | 57.8 | 0.102 | 57.9 | 0.621 | 171.9 |
| 2100 | 0.778 | 145.2 | 1.99 | 56.3 | 0.106 | 56.9 | 0.621 | 171.3 |
| 2200 | 0.778 | 143.6 | 1.91 | 54.9 | 0.111 | 56.0 | 0.621 | 170.6 |
| 2300 | 0.780 | 142.2 | 1.83 | 53.7 | 0.115 | 55.0 | 0.620 | 170.0 |
| 2400 | 0.780 | 140.9 | 1.76 | 52.4 | 0.119 | 54.0 | 0.620 | 169.4 |
| 2500 | 0.780 | 139.6 | 1.69 | 51.0 | 0.124 | 53.1 | 0.619 | 168.8 |
| 2600 | 0.777 | 138.0 | 1.63 | 49.5 | 0.128 | 52.0 | 0.618 | 168.2 |
| 2700 | 0.776 | 136.4 | 1.57 | 48.0 | 0.132 | 51.1 | 0.618 | 167.6 |
| 2800 | 0.775 | 134.9 | 1.52 | 46.6 | 0.137 | 50.0 | 0.617 | 167.0 |
| 2900 | 0.776 | 133.6 | 1.48 | 45.3 | 0.141 | 49.0 | 0.616 | 166.4 |
| 3000 | 0.777 | 132.3 | 1.43 | 44.0 | 0.145 | 47.8 | 0.615 | 165.8 |

S parameter

 $(V_{CE} = 3 \text{ V}, I_C = 200 \text{ mA}, Z_o = 50 \Omega)$

| f (MHz) | S11 | | S21 | | S12 | | S22 | |
|---------|-------|-------|-------|------|-------|------|-------|--------|
| | MAG | ANG | MAG | ANG | MAG | ANG | MAG | ANG |
| 400 | 0.781 | 176.2 | 11.06 | 84.5 | 0.025 | 67.5 | 0.602 | -168.9 |
| 500 | 0.782 | 173.7 | 8.73 | 81.7 | 0.030 | 68.0 | 0.606 | -171.9 |
| 600 | 0.784 | 171.4 | 7.18 | 79.4 | 0.035 | 68.4 | 0.610 | -174.1 |
| 700 | 0.785 | 169.3 | 6.10 | 77.4 | 0.040 | 68.4 | 0.613 | -175.9 |
| 800 | 0.785 | 167.1 | 5.29 | 75.6 | 0.045 | 67.7 | 0.615 | -177.6 |
| 900 | 0.784 | 165.1 | 4.67 | 74.0 | 0.050 | 67.2 | 0.618 | -178.9 |
| 1000 | 0.785 | 163.2 | 4.17 | 72.5 | 0.055 | 66.7 | 0.619 | 179.8 |
| 1100 | 0.786 | 161.4 | 3.78 | 71.0 | 0.060 | 66.4 | 0.620 | 178.7 |
| 1200 | 0.785 | 159.7 | 3.45 | 69.5 | 0.065 | 65.6 | 0.621 | 177.7 |
| 1300 | 0.784 | 157.9 | 3.18 | 68.0 | 0.070 | 64.7 | 0.622 | 176.8 |
| 1400 | 0.784 | 156.1 | 2.95 | 66.5 | 0.074 | 64.0 | 0.623 | 175.9 |
| 1500 | 0.783 | 154.3 | 2.75 | 65.0 | 0.079 | 63.0 | 0.623 | 175.0 |
| 1600 | 0.784 | 152.6 | 2.58 | 63.7 | 0.084 | 62.2 | 0.624 | 174.3 |
| 1700 | 0.786 | 151.2 | 2.43 | 62.3 | 0.089 | 61.3 | 0.625 | 173.6 |
| 1800 | 0.786 | 149.7 | 2.29 | 60.9 | 0.093 | 60.3 | 0.625 | 172.8 |
| 1900 | 0.784 | 148.2 | 2.17 | 59.4 | 0.098 | 59.4 | 0.625 | 172.2 |
| 2000 | 0.782 | 146.6 | 2.06 | 58.0 | 0.102 | 58.5 | 0.624 | 171.6 |
| 2100 | 0.782 | 145.0 | 1.97 | 56.5 | 0.107 | 57.5 | 0.624 | 171.0 |
| 2200 | 0.782 | 143.4 | 1.89 | 55.1 | 0.111 | 56.5 | 0.624 | 170.3 |
| 2300 | 0.784 | 142.0 | 1.81 | 53.8 | 0.116 | 55.5 | 0.624 | 169.7 |
| 2400 | 0.785 | 140.7 | 1.74 | 52.5 | 0.120 | 54.5 | 0.623 | 169.1 |
| 2500 | 0.784 | 139.4 | 1.67 | 51.1 | 0.124 | 53.6 | 0.622 | 168.5 |
| 2600 | 0.781 | 137.8 | 1.61 | 49.6 | 0.129 | 52.4 | 0.621 | 167.9 |
| 2700 | 0.780 | 136.3 | 1.56 | 48.1 | 0.133 | 51.5 | 0.621 | 167.3 |
| 2800 | 0.779 | 134.7 | 1.51 | 46.7 | 0.138 | 50.5 | 0.620 | 166.7 |
| 2900 | 0.780 | 133.4 | 1.46 | 45.4 | 0.142 | 49.4 | 0.619 | 166.0 |
| 3000 | 0.780 | 132.1 | 1.42 | 44.1 | 0.146 | 48.3 | 0.618 | 165.4 |

S parameter

 $(V_{CE} = 3 \text{ V}, I_C = 250 \text{ mA}, Z_o = 50 \Omega)$

| f (MHz) | S11 | | S21 | | S12 | | S22 | |
|---------|-------|--------|-------|------|-------|------|-------|--------|
| | MAG | ANG | MAG | ANG | MAG | ANG | MAG | ANG |
| 400 | 0.752 | -169.6 | 10.13 | 88.1 | 0.037 | 35.1 | 0.519 | -151.2 |
| 500 | 0.757 | -174.8 | 8.03 | 84.0 | 0.040 | 37.3 | 0.518 | -156.9 |
| 600 | 0.761 | -178.8 | 6.62 | 80.7 | 0.043 | 39.4 | 0.520 | -161.0 |
| 700 | 0.763 | 177.8 | 5.62 | 78.0 | 0.046 | 41.4 | 0.522 | -164.2 |
| 800 | 0.764 | 174.7 | 4.87 | 75.5 | 0.050 | 42.8 | 0.524 | -166.7 |
| 900 | 0.765 | 172.0 | 4.29 | 73.4 | 0.053 | 44.0 | 0.526 | -168.9 |
| 1000 | 0.767 | 169.5 | 3.83 | 71.4 | 0.057 | 45.4 | 0.528 | -170.7 |
| 1100 | 0.768 | 167.3 | 3.46 | 69.6 | 0.060 | 46.3 | 0.530 | -172.3 |
| 1200 | 0.769 | 165.2 | 3.15 | 67.8 | 0.064 | 46.7 | 0.531 | -173.6 |
| 1300 | 0.769 | 163.1 | 2.90 | 66.0 | 0.067 | 47.1 | 0.533 | -174.9 |
| 1400 | 0.770 | 161.0 | 2.69 | 64.3 | 0.071 | 47.6 | 0.535 | -176.0 |
| 1500 | 0.770 | 159.0 | 2.50 | 62.6 | 0.074 | 47.7 | 0.536 | -177.0 |
| 1600 | 0.772 | 157.1 | 2.34 | 61.0 | 0.078 | 47.9 | 0.537 | -177.9 |
| 1700 | 0.774 | 155.4 | 2.20 | 59.4 | 0.082 | 48.0 | 0.539 | -178.7 |
| 1800 | 0.775 | 153.8 | 2.07 | 57.8 | 0.086 | 47.7 | 0.540 | -179.4 |
| 1900 | 0.774 | 152.2 | 1.96 | 56.2 | 0.089 | 47.6 | 0.540 | 179.8 |
| 2000 | 0.772 | 150.5 | 1.86 | 54.6 | 0.093 | 47.3 | 0.541 | 179.2 |
| 2100 | 0.773 | 148.7 | 1.78 | 53.0 | 0.097 | 47.0 | 0.542 | 178.6 |
| 2200 | 0.774 | 147.1 | 1.70 | 51.4 | 0.100 | 46.6 | 0.543 | 177.9 |
| 2300 | 0.777 | 145.6 | 1.63 | 50.0 | 0.104 | 46.2 | 0.543 | 177.3 |
| 2400 | 0.778 | 144.2 | 1.56 | 48.6 | 0.108 | 45.7 | 0.543 | 176.8 |
| 2500 | 0.778 | 142.8 | 1.50 | 47.1 | 0.111 | 45.3 | 0.544 | 176.3 |
| 2600 | 0.776 | 141.2 | 1.44 | 45.5 | 0.115 | 44.7 | 0.544 | 175.7 |
| 2700 | 0.775 | 139.6 | 1.39 | 43.9 | 0.119 | 44.2 | 0.544 | 175.1 |
| 2800 | 0.775 | 137.9 | 1.35 | 42.3 | 0.122 | 43.6 | 0.544 | 174.6 |
| 2900 | 0.776 | 136.6 | 1.31 | 40.9 | 0.126 | 42.9 | 0.544 | 174.1 |
| 3000 | 0.778 | 135.2 | 1.27 | 39.5 | 0.130 | 42.2 | 0.545 | 173.5 |

S parameter

 $(V_{CE} = 3.3 \text{ V}, I_C = 10 \text{ mA}, Z_o = 50 \Omega)$

| f (MHz) | S11 | | S21 | | S12 | | S22 | |
|---------|-------|--------|------|------|-------|------|-------|--------|
| | MAG | ANG | MAG | ANG | MAG | ANG | MAG | ANG |
| 400 | 0.748 | -148.7 | 8.07 | 94.2 | 0.061 | 23.5 | 0.473 | -123.3 |
| 500 | 0.751 | -158.3 | 6.56 | 88.2 | 0.062 | 22.2 | 0.454 | -132.2 |
| 600 | 0.755 | -165.3 | 5.49 | 83.5 | 0.063 | 21.8 | 0.445 | -138.7 |
| 700 | 0.757 | -170.6 | 4.69 | 79.8 | 0.065 | 22.0 | 0.441 | -143.8 |
| 800 | 0.760 | -175.0 | 4.07 | 76.5 | 0.066 | 22.2 | 0.439 | -147.7 |
| 900 | 0.761 | -178.7 | 3.59 | 73.8 | 0.067 | 22.7 | 0.439 | -151.1 |
| 1000 | 0.764 | 178.0 | 3.21 | 71.2 | 0.068 | 23.7 | 0.440 | -153.8 |
| 1100 | 0.767 | 175.0 | 2.90 | 68.9 | 0.069 | 24.8 | 0.441 | -156.1 |
| 1200 | 0.769 | 172.3 | 2.65 | 66.7 | 0.071 | 25.6 | 0.443 | -158.1 |
| 1300 | 0.770 | 169.8 | 2.43 | 64.4 | 0.072 | 26.3 | 0.445 | -159.7 |
| 1400 | 0.771 | 167.3 | 2.25 | 62.4 | 0.074 | 27.3 | 0.448 | -161.2 |
| 1500 | 0.772 | 164.9 | 2.10 | 60.3 | 0.075 | 28.2 | 0.450 | -162.5 |
| 1600 | 0.775 | 162.8 | 1.96 | 58.5 | 0.077 | 29.2 | 0.452 | -163.6 |
| 1700 | 0.779 | 160.8 | 1.84 | 56.6 | 0.079 | 29.9 | 0.456 | -164.6 |
| 1800 | 0.780 | 159.0 | 1.73 | 54.7 | 0.081 | 30.5 | 0.458 | -165.5 |
| 1900 | 0.780 | 157.1 | 1.64 | 52.9 | 0.083 | 31.3 | 0.461 | -166.3 |
| 2000 | 0.779 | 155.2 | 1.55 | 51.0 | 0.085 | 31.8 | 0.464 | -167.0 |
| 2100 | 0.781 | 153.3 | 1.48 | 49.2 | 0.087 | 32.4 | 0.466 | -167.7 |
| 2200 | 0.783 | 151.5 | 1.41 | 47.5 | 0.090 | 32.8 | 0.469 | -168.4 |
| 2300 | 0.787 | 149.8 | 1.35 | 45.9 | 0.092 | 33.3 | 0.472 | -169.0 |
| 2400 | 0.788 | 148.3 | 1.29 | 44.3 | 0.094 | 33.6 | 0.474 | -169.6 |
| 2500 | 0.790 | 146.8 | 1.24 | 42.6 | 0.097 | 34.0 | 0.477 | -170.1 |
| 2600 | 0.788 | 145.1 | 1.20 | 40.8 | 0.099 | 34.1 | 0.480 | -170.6 |
| 2700 | 0.788 | 143.3 | 1.15 | 39.1 | 0.102 | 34.3 | 0.482 | -171.2 |
| 2800 | 0.789 | 141.6 | 1.11 | 37.4 | 0.105 | 34.6 | 0.485 | -171.7 |
| 2900 | 0.791 | 140.1 | 1.08 | 36.0 | 0.107 | 34.6 | 0.487 | -172.3 |
| 3000 | 0.794 | 138.7 | 1.04 | 34.5 | 0.110 | 34.6 | 0.490 | -172.8 |

S parameter

 $(V_{CE} = 3.3 \text{ V}, I_C = 20 \text{ mA}, Z_o = 50 \Omega)$

| f (MHz) | S11 | | S21 | | S12 | | S22 | |
|---------|-------|--------|------|------|-------|------|-------|--------|
| | MAG | ANG | MAG | ANG | MAG | ANG | MAG | ANG |
| 400 | 0.748 | -165.5 | 9.86 | 89.3 | 0.041 | 31.3 | 0.500 | -145.4 |
| 500 | 0.752 | -171.6 | 7.85 | 84.8 | 0.044 | 33.0 | 0.496 | -151.9 |
| 600 | 0.757 | -176.1 | 6.48 | 81.3 | 0.046 | 34.4 | 0.496 | -156.6 |
| 700 | 0.759 | -179.9 | 5.50 | 78.3 | 0.049 | 36.3 | 0.497 | -160.1 |
| 800 | 0.761 | 176.8 | 4.77 | 75.7 | 0.052 | 37.7 | 0.499 | -163.0 |
| 900 | 0.762 | 173.9 | 4.20 | 73.4 | 0.054 | 39.0 | 0.501 | -165.4 |
| 1000 | 0.764 | 171.2 | 3.75 | 71.4 | 0.058 | 40.3 | 0.503 | -167.4 |
| 1100 | 0.766 | 168.9 | 3.38 | 69.5 | 0.061 | 41.6 | 0.505 | -169.1 |
| 1200 | 0.767 | 166.6 | 3.08 | 67.6 | 0.064 | 42.4 | 0.507 | -170.6 |
| 1300 | 0.767 | 164.5 | 2.84 | 65.7 | 0.067 | 42.8 | 0.508 | -171.9 |
| 1400 | 0.768 | 162.3 | 2.63 | 63.9 | 0.070 | 43.6 | 0.510 | -173.1 |
| 1500 | 0.768 | 160.2 | 2.44 | 62.1 | 0.074 | 43.9 | 0.512 | -174.2 |
| 1600 | 0.770 | 158.3 | 2.29 | 60.5 | 0.077 | 44.4 | 0.513 | -175.1 |
| 1700 | 0.773 | 156.5 | 2.15 | 58.8 | 0.081 | 44.6 | 0.515 | -175.9 |
| 1800 | 0.774 | 154.9 | 2.02 | 57.2 | 0.084 | 44.5 | 0.516 | -176.7 |
| 1900 | 0.773 | 153.2 | 1.91 | 55.5 | 0.087 | 44.6 | 0.517 | -177.5 |
| 2000 | 0.772 | 151.5 | 1.82 | 53.9 | 0.091 | 44.5 | 0.518 | -178.1 |
| 2100 | 0.773 | 149.7 | 1.73 | 52.2 | 0.094 | 44.3 | 0.520 | -178.7 |
| 2200 | 0.774 | 148.0 | 1.66 | 50.6 | 0.098 | 44.2 | 0.521 | -179.4 |
| 2300 | 0.777 | 146.5 | 1.59 | 49.2 | 0.101 | 43.9 | 0.522 | -179.9 |
| 2400 | 0.778 | 145.1 | 1.52 | 47.7 | 0.104 | 43.6 | 0.522 | 179.5 |
| 2500 | 0.779 | 143.7 | 1.46 | 46.2 | 0.108 | 43.3 | 0.523 | 179.0 |
| 2600 | 0.776 | 142.0 | 1.41 | 44.5 | 0.111 | 42.8 | 0.524 | 178.5 |
| 2700 | 0.776 | 140.4 | 1.36 | 42.9 | 0.115 | 42.4 | 0.524 | 177.9 |
| 2800 | 0.776 | 138.8 | 1.31 | 41.3 | 0.118 | 41.9 | 0.525 | 177.4 |
| 2900 | 0.778 | 137.4 | 1.27 | 39.9 | 0.122 | 41.4 | 0.525 | 176.9 |
| 3000 | 0.779 | 136.0 | 1.23 | 38.5 | 0.125 | 40.8 | 0.526 | 176.3 |

S parameter

(V_{CE} = 3.3 V, I_C = 30 mA, Z_o = 50 Ω)

| f (MHz) | S11 | | S21 | | S12 | | S22 | |
|---------|-------|--------|-------|------|-------|------|-------|--------|
| | MAG | ANG | MAG | ANG | MAG | ANG | MAG | ANG |
| 400 | 0.753 | -171.8 | 10.53 | 87.5 | 0.034 | 38.6 | 0.525 | -153.8 |
| 500 | 0.757 | -176.5 | 8.34 | 83.6 | 0.038 | 40.8 | 0.526 | -159.1 |
| 600 | 0.761 | 179.7 | 6.87 | 80.5 | 0.041 | 43.4 | 0.528 | -162.9 |
| 700 | 0.763 | 176.4 | 5.83 | 77.8 | 0.044 | 45.1 | 0.530 | -165.9 |
| 800 | 0.764 | 173.6 | 5.05 | 75.5 | 0.048 | 46.5 | 0.532 | -168.3 |
| 900 | 0.765 | 170.9 | 4.44 | 73.4 | 0.052 | 47.5 | 0.535 | -170.4 |
| 1000 | 0.766 | 168.5 | 3.97 | 71.5 | 0.056 | 48.8 | 0.537 | -172.1 |
| 1100 | 0.768 | 166.4 | 3.58 | 69.8 | 0.059 | 49.5 | 0.539 | -173.5 |
| 1200 | 0.768 | 164.3 | 3.27 | 68.0 | 0.063 | 49.8 | 0.541 | -174.9 |
| 1300 | 0.768 | 162.3 | 3.00 | 66.3 | 0.067 | 50.1 | 0.542 | -176.0 |
| 1400 | 0.768 | 160.3 | 2.78 | 64.6 | 0.071 | 50.4 | 0.543 | -177.1 |
| 1500 | 0.768 | 158.3 | 2.59 | 62.9 | 0.075 | 50.4 | 0.545 | -178.1 |
| 1600 | 0.770 | 156.5 | 2.42 | 61.4 | 0.079 | 50.4 | 0.546 | -179.0 |
| 1700 | 0.773 | 154.8 | 2.28 | 59.8 | 0.083 | 50.2 | 0.547 | -179.8 |
| 1800 | 0.773 | 153.2 | 2.15 | 58.3 | 0.086 | 50.0 | 0.548 | 179.4 |
| 1900 | 0.772 | 151.6 | 2.03 | 56.7 | 0.090 | 49.7 | 0.549 | 178.7 |
| 2000 | 0.770 | 149.9 | 1.93 | 55.1 | 0.094 | 49.3 | 0.549 | 178.1 |
| 2100 | 0.771 | 148.2 | 1.84 | 53.5 | 0.098 | 48.9 | 0.550 | 177.5 |
| 2200 | 0.772 | 146.5 | 1.76 | 52.0 | 0.102 | 48.4 | 0.551 | 176.8 |
| 2300 | 0.775 | 145.0 | 1.69 | 50.6 | 0.105 | 47.9 | 0.551 | 176.2 |
| 2400 | 0.775 | 143.7 | 1.62 | 49.2 | 0.109 | 47.3 | 0.551 | 175.7 |
| 2500 | 0.776 | 142.3 | 1.55 | 47.7 | 0.113 | 46.8 | 0.551 | 175.1 |
| 2600 | 0.773 | 140.7 | 1.50 | 46.2 | 0.117 | 46.0 | 0.551 | 174.6 |
| 2700 | 0.772 | 139.1 | 1.44 | 44.6 | 0.121 | 45.5 | 0.551 | 174.0 |
| 2800 | 0.772 | 137.5 | 1.40 | 43.0 | 0.124 | 44.7 | 0.551 | 173.5 |
| 2900 | 0.773 | 136.1 | 1.35 | 41.7 | 0.128 | 44.1 | 0.551 | 172.9 |
| 3000 | 0.775 | 134.8 | 1.31 | 40.3 | 0.132 | 43.2 | 0.551 | 172.3 |

S parameter

(V_{CE} = 3.3 V, I_C = 50 mA, Z_o = 50 Ω)

| f (MHz) | S11 | | S21 | | S12 | | S22 | |
|---------|-------|--------|-------|------|-------|------|-------|--------|
| | MAG | ANG | MAG | ANG | MAG | ANG | MAG | ANG |
| 400 | 0.760 | -177.2 | 11.09 | 86.0 | 0.029 | 48.6 | 0.554 | -160.8 |
| 500 | 0.763 | 179.1 | 8.76 | 82.6 | 0.033 | 51.5 | 0.557 | -165.1 |
| 600 | 0.766 | 176.0 | 7.21 | 79.8 | 0.037 | 53.2 | 0.561 | -168.1 |
| 700 | 0.767 | 173.3 | 6.11 | 77.4 | 0.042 | 54.6 | 0.564 | -170.5 |
| 800 | 0.768 | 170.7 | 5.30 | 75.3 | 0.046 | 55.5 | 0.567 | -172.6 |
| 900 | 0.768 | 168.3 | 4.66 | 73.4 | 0.050 | 56.0 | 0.569 | -174.3 |
| 1000 | 0.770 | 166.2 | 4.16 | 71.7 | 0.055 | 56.7 | 0.571 | -175.8 |
| 1100 | 0.771 | 164.2 | 3.76 | 70.1 | 0.059 | 57.1 | 0.573 | -177.1 |
| 1200 | 0.771 | 162.3 | 3.43 | 68.5 | 0.063 | 56.8 | 0.575 | -178.3 |
| 1300 | 0.770 | 160.4 | 3.16 | 66.9 | 0.068 | 56.6 | 0.576 | -179.4 |
| 1400 | 0.770 | 158.4 | 2.93 | 65.2 | 0.072 | 56.6 | 0.577 | 179.6 |
| 1500 | 0.770 | 156.5 | 2.72 | 63.7 | 0.076 | 56.1 | 0.578 | 178.7 |
| 1600 | 0.771 | 154.8 | 2.55 | 62.3 | 0.081 | 55.8 | 0.579 | 177.9 |
| 1700 | 0.774 | 153.2 | 2.40 | 60.8 | 0.085 | 55.3 | 0.580 | 177.1 |
| 1800 | 0.773 | 151.7 | 2.26 | 59.3 | 0.089 | 54.6 | 0.581 | 176.4 |
| 1900 | 0.772 | 150.1 | 2.14 | 57.8 | 0.093 | 54.1 | 0.581 | 175.6 |
| 2000 | 0.770 | 148.5 | 2.03 | 56.3 | 0.097 | 53.4 | 0.581 | 175.0 |
| 2100 | 0.771 | 146.8 | 1.94 | 54.8 | 0.102 | 52.7 | 0.581 | 174.4 |
| 2200 | 0.771 | 145.2 | 1.85 | 53.3 | 0.106 | 51.9 | 0.581 | 173.7 |
| 2300 | 0.774 | 143.7 | 1.78 | 52.0 | 0.110 | 51.3 | 0.581 | 173.1 |
| 2400 | 0.774 | 142.4 | 1.70 | 50.7 | 0.114 | 50.5 | 0.581 | 172.6 |
| 2500 | 0.774 | 141.1 | 1.64 | 49.2 | 0.118 | 49.7 | 0.581 | 172.0 |
| 2600 | 0.771 | 139.5 | 1.58 | 47.7 | 0.122 | 48.8 | 0.580 | 171.4 |
| 2700 | 0.770 | 137.9 | 1.52 | 46.2 | 0.126 | 48.1 | 0.580 | 170.8 |
| 2800 | 0.770 | 136.3 | 1.47 | 44.7 | 0.130 | 47.2 | 0.579 | 170.2 |
| 2900 | 0.771 | 135.0 | 1.43 | 43.3 | 0.134 | 46.3 | 0.579 | 169.7 |
| 3000 | 0.772 | 133.7 | 1.39 | 42.0 | 0.138 | 45.4 | 0.578 | 169.1 |

S parameter

(V_{CE} = 3.3 V, I_C = 70 mA, Z_o = 50 Ω)

| f (MHz) | S11 | | S21 | | S12 | | S22 | |
|---------|-------|--------|-------|------|-------|------|-------|--------|
| | MAG | ANG | MAG | ANG | MAG | ANG | MAG | ANG |
| 400 | 0.764 | -179.6 | 11.32 | 85.4 | 0.027 | 54.3 | 0.570 | -163.9 |
| 500 | 0.767 | 177.1 | 8.94 | 82.2 | 0.031 | 57.0 | 0.574 | -167.6 |
| 600 | 0.769 | 174.4 | 7.35 | 79.6 | 0.036 | 58.7 | 0.578 | -170.3 |
| 700 | 0.770 | 171.8 | 6.23 | 77.3 | 0.041 | 59.5 | 0.581 | -172.5 |
| 800 | 0.771 | 169.4 | 5.40 | 75.3 | 0.045 | 60.0 | 0.583 | -174.4 |
| 900 | 0.771 | 167.2 | 4.75 | 73.5 | 0.050 | 60.5 | 0.586 | -176.0 |
| 1000 | 0.772 | 165.1 | 4.25 | 71.9 | 0.055 | 60.4 | 0.588 | -177.4 |
| 1100 | 0.773 | 163.2 | 3.84 | 70.3 | 0.059 | 60.6 | 0.590 | -178.6 |
| 1200 | 0.773 | 161.3 | 3.50 | 68.8 | 0.064 | 60.2 | 0.591 | -179.8 |
| 1300 | 0.772 | 159.5 | 3.22 | 67.2 | 0.068 | 59.5 | 0.592 | 179.2 |
| 1400 | 0.772 | 157.6 | 2.99 | 65.6 | 0.073 | 59.3 | 0.594 | 178.2 |
| 1500 | 0.771 | 155.7 | 2.78 | 64.1 | 0.077 | 58.6 | 0.594 | 177.3 |
| 1600 | 0.773 | 154.0 | 2.60 | 62.8 | 0.082 | 58.2 | 0.595 | 176.5 |
| 1700 | 0.775 | 152.4 | 2.45 | 61.3 | 0.086 | 57.4 | 0.596 | 175.8 |
| 1800 | 0.775 | 151.0 | 2.31 | 59.9 | 0.090 | 56.7 | 0.596 | 175.1 |
| 1900 | 0.773 | 149.4 | 2.19 | 58.4 | 0.095 | 56.1 | 0.596 | 174.3 |
| 2000 | 0.771 | 147.8 | 2.08 | 56.9 | 0.099 | 55.3 | 0.596 | 173.8 |
| 2100 | 0.771 | 146.1 | 1.98 | 55.4 | 0.103 | 54.4 | 0.596 | 173.1 |
| 2200 | 0.772 | 144.5 | 1.90 | 54.0 | 0.108 | 53.6 | 0.597 | 172.5 |
| 2300 | 0.774 | 143.1 | 1.82 | 52.7 | 0.112 | 52.8 | 0.596 | 171.8 |
| 2400 | 0.774 | 141.8 | 1.74 | 51.4 | 0.116 | 52.0 | 0.596 | 171.3 |
| 2500 | 0.774 | 140.5 | 1.68 | 50.0 | 0.120 | 51.2 | 0.595 | 170.7 |
| 2600 | 0.771 | 138.9 | 1.62 | 48.4 | 0.124 | 50.2 | 0.594 | 170.1 |
| 2700 | 0.770 | 137.3 | 1.56 | 46.9 | 0.129 | 49.3 | 0.594 | 169.5 |
| 2800 | 0.770 | 135.7 | 1.51 | 45.5 | 0.133 | 48.4 | 0.593 | 168.9 |
| 2900 | 0.770 | 134.4 | 1.46 | 44.2 | 0.137 | 47.5 | 0.592 | 168.3 |
| 3000 | 0.772 | 133.1 | 1.42 | 42.8 | 0.141 | 46.3 | 0.592 | 167.7 |

S parameter

(V_{CE} = 3.3 V, I_C = 100 mA, Z_o = 50 Ω)

| f (MHz) | S11 | | S21 | | S12 | | S22 | |
|---------|-------|-------|-------|------|-------|------|-------|--------|
| | MAG | ANG | MAG | ANG | MAG | ANG | MAG | ANG |
| 400 | 0.768 | 178.6 | 11.44 | 84.9 | 0.026 | 60.2 | 0.582 | -166.1 |
| 500 | 0.770 | 175.7 | 9.03 | 81.9 | 0.031 | 61.7 | 0.587 | -169.5 |
| 600 | 0.773 | 173.1 | 7.43 | 79.4 | 0.035 | 62.5 | 0.591 | -172.0 |
| 700 | 0.773 | 170.7 | 6.30 | 77.3 | 0.040 | 63.4 | 0.594 | -174.0 |
| 800 | 0.773 | 168.4 | 5.46 | 75.4 | 0.045 | 63.7 | 0.596 | -175.8 |
| 900 | 0.774 | 166.3 | 4.81 | 73.6 | 0.050 | 63.2 | 0.599 | -177.3 |
| 1000 | 0.774 | 164.2 | 4.30 | 72.0 | 0.055 | 63.2 | 0.601 | -178.6 |
| 1100 | 0.775 | 162.4 | 3.88 | 70.6 | 0.059 | 63.0 | 0.602 | -179.8 |
| 1200 | 0.775 | 160.6 | 3.54 | 69.0 | 0.064 | 62.4 | 0.604 | 179.1 |
| 1300 | 0.774 | 158.8 | 3.26 | 67.5 | 0.069 | 61.8 | 0.605 | 178.1 |
| 1400 | 0.774 | 156.9 | 3.03 | 66.0 | 0.074 | 61.4 | 0.606 | 177.2 |
| 1500 | 0.773 | 155.1 | 2.82 | 64.5 | 0.078 | 60.7 | 0.606 | 176.4 |
| 1600 | 0.775 | 153.5 | 2.64 | 63.2 | 0.083 | 60.1 | 0.607 | 175.6 |
| 1700 | 0.777 | 151.9 | 2.48 | 61.7 | 0.087 | 59.1 | 0.608 | 174.8 |
| 1800 | 0.776 | 150.4 | 2.34 | 60.3 | 0.092 | 58.2 | 0.609 | 174.1 |
| 1900 | 0.775 | 148.9 | 2.22 | 58.9 | 0.096 | 57.6 | 0.608 | 173.4 |
| 2000 | 0.772 | 147.3 | 2.11 | 57.4 | 0.100 | 56.7 | 0.608 | 172.8 |
| 2100 | 0.773 | 145.6 | 2.01 | 55.9 | 0.105 | 55.8 | 0.608 | 172.2 |
| 2200 | 0.773 | 144.0 | 1.92 | 54.5 | 0.109 | 54.9 | 0.608 | 171.5 |
| 2300 | 0.775 | 142.6 | 1.84 | 53.3 | 0.113 | 54.0 | 0.608 | 170.9 |
| 2400 | 0.775 | 141.3 | 1.77 | 51.9 | 0.118 | 53.0 | 0.607 | 170.3 |
| 2500 | 0.776 | 140.0 | 1.70 | 50.6 | 0.122 | 52.2 | 0.607 | 169.7 |
| 2600 | 0.773 | 138.4 | 1.64 | 49.0 | 0.126 | 51.2 | 0.606 | 169.1 |
| 2700 | 0.771 | 136.8 | 1.59 | 47.5 | 0.131 | 50.3 | 0.605 | 168.5 |
| 2800 | 0.771 | 135.3 | 1.53 | 46.1 | 0.135 | 49.3 | 0.604 | 167.9 |
| 2900 | 0.771 | 134.0 | 1.49 | 44.8 | 0.139 | 48.3 | 0.604 | 167.3 |
| 3000 | 0.772 | 132.7 | 1.44 | 43.5 | 0.143 | 47.2 | 0.603 | 166.7 |

S parameter $(V_{CE} = 3.3 \text{ V}, I_C = 150 \text{ mA}, Z_o = 50 \Omega)$

| f (MHz) | S11 | | S21 | | S12 | | S22 | |
|---------|-------|-------|-------|------|-------|------|-------|--------|
| | MAG | ANG | MAG | ANG | MAG | ANG | MAG | ANG |
| 400 | 0.773 | 177.1 | 11.42 | 84.6 | 0.025 | 64.5 | 0.593 | -167.8 |
| 500 | 0.775 | 174.4 | 9.01 | 81.7 | 0.030 | 65.7 | 0.598 | -170.9 |
| 600 | 0.777 | 172.1 | 7.41 | 79.4 | 0.035 | 66.5 | 0.602 | -173.2 |
| 700 | 0.778 | 169.8 | 6.29 | 77.3 | 0.040 | 66.5 | 0.605 | -175.2 |
| 800 | 0.777 | 167.6 | 5.45 | 75.5 | 0.045 | 66.2 | 0.607 | -176.8 |
| 900 | 0.777 | 165.5 | 4.81 | 73.8 | 0.050 | 66.2 | 0.609 | -178.3 |
| 1000 | 0.778 | 163.6 | 4.30 | 72.3 | 0.055 | 65.7 | 0.611 | -179.6 |
| 1100 | 0.779 | 161.8 | 3.89 | 70.8 | 0.060 | 65.3 | 0.612 | 179.3 |
| 1200 | 0.779 | 160.0 | 3.55 | 69.3 | 0.065 | 64.6 | 0.613 | 178.3 |
| 1300 | 0.777 | 158.3 | 3.27 | 67.8 | 0.069 | 63.8 | 0.614 | 177.3 |
| 1400 | 0.777 | 156.4 | 3.03 | 66.3 | 0.074 | 63.1 | 0.615 | 176.4 |
| 1500 | 0.776 | 154.6 | 2.83 | 64.8 | 0.079 | 62.2 | 0.616 | 175.5 |
| 1600 | 0.778 | 153.0 | 2.65 | 63.5 | 0.084 | 61.4 | 0.616 | 174.8 |
| 1700 | 0.780 | 151.4 | 2.49 | 62.1 | 0.088 | 60.5 | 0.618 | 174.1 |
| 1800 | 0.779 | 150.0 | 2.35 | 60.7 | 0.093 | 59.6 | 0.618 | 173.3 |
| 1900 | 0.778 | 148.4 | 2.23 | 59.3 | 0.097 | 58.9 | 0.617 | 172.6 |
| 2000 | 0.775 | 146.9 | 2.12 | 57.8 | 0.101 | 57.9 | 0.617 | 172.1 |
| 2100 | 0.776 | 145.2 | 2.02 | 56.4 | 0.106 | 56.9 | 0.617 | 171.5 |
| 2200 | 0.776 | 143.6 | 1.93 | 54.9 | 0.110 | 55.9 | 0.617 | 170.8 |
| 2300 | 0.778 | 142.2 | 1.85 | 53.7 | 0.115 | 55.0 | 0.616 | 170.1 |
| 2400 | 0.778 | 140.9 | 1.78 | 52.4 | 0.119 | 54.1 | 0.615 | 169.6 |
| 2500 | 0.778 | 139.6 | 1.71 | 51.0 | 0.124 | 53.1 | 0.615 | 169.0 |
| 2600 | 0.775 | 138.0 | 1.65 | 49.5 | 0.128 | 52.0 | 0.614 | 168.4 |
| 2700 | 0.774 | 136.5 | 1.59 | 48.0 | 0.132 | 51.0 | 0.614 | 167.8 |
| 2800 | 0.773 | 134.9 | 1.54 | 46.5 | 0.136 | 50.0 | 0.613 | 167.1 |
| 2900 | 0.774 | 133.6 | 1.50 | 45.3 | 0.141 | 49.1 | 0.612 | 166.5 |
| 3000 | 0.775 | 132.3 | 1.45 | 44.0 | 0.145 | 47.9 | 0.611 | 165.9 |

S parameter $(V_{CE} = 3.3 \text{ V}, I_C = 200 \text{ mA}, Z_o = 50 \Omega)$

| f (MHz) | S11 | | S21 | | S12 | | S22 | |
|---------|-------|-------|-------|------|-------|------|-------|--------|
| | MAG | ANG | MAG | ANG | MAG | ANG | MAG | ANG |
| 400 | 0.778 | 176.3 | 11.25 | 84.5 | 0.025 | 66.8 | 0.598 | -168.7 |
| 500 | 0.780 | 173.8 | 8.87 | 81.7 | 0.030 | 68.3 | 0.603 | -171.7 |
| 600 | 0.782 | 171.5 | 7.30 | 79.4 | 0.035 | 68.4 | 0.606 | -173.9 |
| 700 | 0.782 | 169.3 | 6.20 | 77.4 | 0.040 | 68.2 | 0.609 | -175.8 |
| 800 | 0.782 | 167.2 | 5.38 | 75.6 | 0.045 | 67.8 | 0.611 | -177.4 |
| 900 | 0.782 | 165.1 | 4.74 | 74.0 | 0.050 | 67.4 | 0.614 | -178.8 |
| 1000 | 0.782 | 163.2 | 4.24 | 72.5 | 0.055 | 66.9 | 0.615 | 179.9 |
| 1100 | 0.783 | 161.5 | 3.84 | 71.0 | 0.060 | 66.5 | 0.616 | 178.8 |
| 1200 | 0.783 | 159.7 | 3.50 | 69.5 | 0.065 | 65.5 | 0.617 | 177.8 |
| 1300 | 0.782 | 158.0 | 3.23 | 68.0 | 0.070 | 64.5 | 0.618 | 176.9 |
| 1400 | 0.781 | 156.1 | 3.00 | 66.5 | 0.075 | 63.9 | 0.619 | 175.9 |
| 1500 | 0.780 | 154.3 | 2.79 | 65.0 | 0.079 | 63.1 | 0.619 | 175.1 |
| 1600 | 0.782 | 152.7 | 2.62 | 63.7 | 0.084 | 62.3 | 0.620 | 174.5 |
| 1700 | 0.784 | 151.2 | 2.47 | 62.3 | 0.089 | 61.4 | 0.622 | 173.7 |
| 1800 | 0.783 | 149.7 | 2.32 | 60.9 | 0.093 | 60.3 | 0.621 | 172.9 |
| 1900 | 0.782 | 148.2 | 2.20 | 59.4 | 0.097 | 59.6 | 0.621 | 172.2 |
| 2000 | 0.779 | 146.6 | 2.10 | 58.0 | 0.102 | 58.5 | 0.620 | 171.7 |
| 2100 | 0.779 | 145.0 | 2.00 | 56.5 | 0.107 | 57.5 | 0.621 | 171.1 |
| 2200 | 0.780 | 143.4 | 1.92 | 55.1 | 0.111 | 56.5 | 0.620 | 170.4 |
| 2300 | 0.782 | 142.0 | 1.84 | 53.8 | 0.115 | 55.6 | 0.620 | 169.8 |
| 2400 | 0.782 | 140.7 | 1.76 | 52.5 | 0.120 | 54.6 | 0.619 | 169.2 |
| 2500 | 0.782 | 139.4 | 1.70 | 51.2 | 0.125 | 53.6 | 0.619 | 168.6 |
| 2600 | 0.779 | 137.8 | 1.64 | 49.6 | 0.129 | 52.5 | 0.618 | 168.0 |
| 2700 | 0.777 | 136.3 | 1.58 | 48.2 | 0.133 | 51.6 | 0.617 | 167.4 |
| 2800 | 0.777 | 134.7 | 1.53 | 46.7 | 0.137 | 50.5 | 0.616 | 166.8 |
| 2900 | 0.778 | 133.4 | 1.48 | 45.4 | 0.142 | 49.5 | 0.615 | 166.2 |
| 3000 | 0.779 | 132.1 | 1.44 | 44.1 | 0.146 | 48.4 | 0.615 | 165.5 |

S parameter

 $(V_{CE} = 3.3 \text{ V}, I_C = 250 \text{ mA}, Z_o = 50 \Omega)$

| f (MHz) | S11 | | S21 | | S12 | | S22 | |
|---------|-------|--------|-------|------|-------|------|-------|--------|
| | MAG | ANG | MAG | ANG | MAG | ANG | MAG | ANG |
| 400 | 0.750 | -169.3 | 10.27 | 88.2 | 0.037 | 35.1 | 0.513 | -150.5 |
| 500 | 0.755 | -174.5 | 8.14 | 84.1 | 0.040 | 37.2 | 0.513 | -156.2 |
| 600 | 0.759 | -178.6 | 6.71 | 80.8 | 0.043 | 39.2 | 0.514 | -160.4 |
| 700 | 0.761 | 177.9 | 5.70 | 78.0 | 0.046 | 41.4 | 0.516 | -163.6 |
| 800 | 0.762 | 174.9 | 4.94 | 75.6 | 0.049 | 42.9 | 0.518 | -166.2 |
| 900 | 0.763 | 172.1 | 4.34 | 73.4 | 0.053 | 44.0 | 0.520 | -168.4 |
| 1000 | 0.765 | 169.6 | 3.88 | 71.4 | 0.056 | 45.3 | 0.522 | -170.2 |
| 1100 | 0.767 | 167.4 | 3.50 | 69.6 | 0.060 | 46.3 | 0.524 | -171.8 |
| 1200 | 0.767 | 165.3 | 3.19 | 67.8 | 0.063 | 46.8 | 0.526 | -173.2 |
| 1300 | 0.768 | 163.2 | 2.94 | 66.0 | 0.067 | 47.2 | 0.528 | -174.4 |
| 1400 | 0.768 | 161.1 | 2.72 | 64.3 | 0.071 | 47.5 | 0.529 | -175.6 |
| 1500 | 0.768 | 159.1 | 2.53 | 62.6 | 0.074 | 47.8 | 0.531 | -176.6 |
| 1600 | 0.770 | 157.2 | 2.37 | 61.0 | 0.078 | 48.0 | 0.532 | -177.5 |
| 1700 | 0.773 | 155.5 | 2.22 | 59.4 | 0.082 | 48.0 | 0.534 | -178.3 |
| 1800 | 0.773 | 153.9 | 2.10 | 57.8 | 0.085 | 47.8 | 0.535 | -179.1 |
| 1900 | 0.772 | 152.2 | 1.98 | 56.2 | 0.089 | 47.6 | 0.536 | -179.8 |
| 2000 | 0.771 | 150.5 | 1.88 | 54.6 | 0.093 | 47.4 | 0.536 | 179.6 |
| 2100 | 0.772 | 148.8 | 1.80 | 53.0 | 0.096 | 47.1 | 0.537 | 179.0 |
| 2200 | 0.773 | 147.2 | 1.72 | 51.4 | 0.100 | 46.7 | 0.538 | 178.3 |
| 2300 | 0.776 | 145.6 | 1.64 | 50.0 | 0.104 | 46.2 | 0.538 | 177.7 |
| 2400 | 0.776 | 144.3 | 1.58 | 48.6 | 0.107 | 45.8 | 0.538 | 177.2 |
| 2500 | 0.776 | 142.9 | 1.52 | 47.1 | 0.111 | 45.3 | 0.539 | 176.7 |
| 2600 | 0.775 | 141.3 | 1.46 | 45.5 | 0.114 | 44.8 | 0.539 | 176.1 |
| 2700 | 0.774 | 139.6 | 1.41 | 43.9 | 0.118 | 44.2 | 0.539 | 175.6 |
| 2800 | 0.773 | 138.0 | 1.36 | 42.3 | 0.122 | 43.6 | 0.540 | 175.0 |
| 2900 | 0.775 | 136.6 | 1.32 | 40.9 | 0.126 | 43.1 | 0.540 | 174.5 |
| 3000 | 0.777 | 135.3 | 1.28 | 39.6 | 0.129 | 42.2 | 0.540 | 173.9 |

S parameter

 $(V_{CE} = 3.6 \text{ V}, I_C = 10 \text{ mA}, Z_o = 50 \Omega)$

| f (MHz) | S11 | | S21 | | S12 | | S22 | |
|---------|-------|--------|------|------|-------|------|-------|--------|
| | MAG | ANG | MAG | ANG | MAG | ANG | MAG | ANG |
| 400 | 0.747 | -147.9 | 8.12 | 94.5 | 0.060 | 23.5 | 0.470 | -122.0 |
| 500 | 0.750 | -157.7 | 6.61 | 88.4 | 0.062 | 22.2 | 0.451 | -131.0 |
| 600 | 0.754 | -164.9 | 5.53 | 83.7 | 0.063 | 21.6 | 0.441 | -137.6 |
| 700 | 0.756 | -170.2 | 4.73 | 79.9 | 0.064 | 21.8 | 0.437 | -142.7 |
| 800 | 0.759 | -174.7 | 4.11 | 76.6 | 0.065 | 22.1 | 0.435 | -146.8 |
| 900 | 0.761 | -178.4 | 3.62 | 73.8 | 0.066 | 22.8 | 0.435 | -150.1 |
| 1000 | 0.764 | -178.2 | 3.23 | 71.3 | 0.068 | 23.7 | 0.436 | -152.9 |
| 1100 | 0.766 | -175.2 | 2.93 | 68.9 | 0.069 | 24.7 | 0.437 | -155.3 |
| 1200 | 0.768 | -172.5 | 2.67 | 66.7 | 0.070 | 25.5 | 0.439 | -157.3 |
| 1300 | 0.769 | -170.0 | 2.45 | 64.4 | 0.072 | 26.3 | 0.441 | -158.9 |
| 1400 | 0.770 | -167.5 | 2.27 | 62.3 | 0.073 | 27.3 | 0.443 | -160.4 |
| 1500 | 0.771 | -165.1 | 2.11 | 60.3 | 0.075 | 28.1 | 0.446 | -161.7 |
| 1600 | 0.774 | -163.0 | 1.97 | 58.5 | 0.077 | 29.0 | 0.448 | -162.9 |
| 1700 | 0.778 | -161.0 | 1.85 | 56.6 | 0.079 | 29.9 | 0.452 | -163.9 |
| 1800 | 0.779 | -159.1 | 1.74 | 54.7 | 0.080 | 30.4 | 0.454 | -164.8 |
| 1900 | 0.779 | -157.2 | 1.65 | 52.8 | 0.082 | 31.2 | 0.457 | -165.7 |
| 2000 | 0.778 | -155.4 | 1.57 | 51.0 | 0.084 | 31.9 | 0.459 | -166.3 |
| 2100 | 0.781 | -153.5 | 1.49 | 49.2 | 0.087 | 32.3 | 0.462 | -167.0 |
| 2200 | 0.783 | -151.6 | 1.42 | 47.4 | 0.089 | 32.8 | 0.465 | -167.7 |
| 2300 | 0.786 | -149.9 | 1.36 | 45.9 | 0.091 | 33.3 | 0.468 | -168.3 |
| 2400 | 0.788 | -148.4 | 1.30 | 44.3 | 0.094 | 33.7 | 0.470 | -168.9 |
| 2500 | 0.789 | -146.9 | 1.25 | 42.6 | 0.096 | 34.0 | 0.473 | -169.4 |
| 2600 | 0.788 | -145.2 | 1.20 | 40.8 | 0.098 | 34.0 | 0.476 | -170.0 |
| 2700 | 0.788 | -143.4 | 1.16 | 39.1 | 0.101 | 34.5 | 0.478 | -170.5 |
| 2800 | 0.788 | -141.7 | 1.12 | 37.4 | 0.104 | 34.6 | 0.481 | -171.1 |
| 2900 | 0.791 | -140.2 | 1.08 | 35.9 | 0.107 | 34.7 | 0.484 | -171.6 |
| 3000 | 0.793 | -138.8 | 1.05 | 34.4 | 0.110 | 34.7 | 0.486 | -172.1 |

S parameter

 $(V_{CE} = 3.6 \text{ V}, I_C = 20 \text{ mA}, Z_o = 50 \Omega)$

| f (MHz) | S11 | | S21 | | S12 | | S22 | |
|---------|-------|--------|------|------|-------|------|-------|--------|
| | MAG | ANG | MAG | ANG | MAG | ANG | MAG | ANG |
| 400 | 0.746 | -165.2 | 9.97 | 89.5 | 0.041 | 31.0 | 0.494 | -144.7 |
| 500 | 0.751 | -171.3 | 7.94 | 84.9 | 0.044 | 32.7 | 0.491 | -151.3 |
| 600 | 0.755 | -175.9 | 6.56 | 81.4 | 0.046 | 34.2 | 0.491 | -156.0 |
| 700 | 0.758 | -179.7 | 5.57 | 78.4 | 0.049 | 36.5 | 0.492 | -159.6 |
| 800 | 0.759 | 177.0 | 4.82 | 75.8 | 0.051 | 37.9 | 0.494 | -162.5 |
| 900 | 0.760 | 174.0 | 4.25 | 73.5 | 0.054 | 39.3 | 0.496 | -164.9 |
| 1000 | 0.763 | 171.4 | 3.79 | 71.4 | 0.058 | 40.5 | 0.498 | -166.9 |
| 1100 | 0.764 | 169.0 | 3.42 | 69.5 | 0.061 | 41.6 | 0.500 | -168.7 |
| 1200 | 0.765 | 166.7 | 3.12 | 67.6 | 0.064 | 42.5 | 0.502 | -170.2 |
| 1300 | 0.766 | 164.6 | 2.87 | 65.7 | 0.067 | 42.9 | 0.503 | -171.5 |
| 1400 | 0.766 | 162.4 | 2.66 | 63.8 | 0.070 | 43.7 | 0.505 | -172.7 |
| 1500 | 0.767 | 160.3 | 2.47 | 62.1 | 0.073 | 44.0 | 0.507 | -173.8 |
| 1600 | 0.769 | 158.4 | 2.31 | 60.5 | 0.077 | 44.5 | 0.508 | -174.7 |
| 1700 | 0.772 | 156.6 | 2.17 | 58.8 | 0.080 | 44.6 | 0.511 | -175.5 |
| 1800 | 0.772 | 155.0 | 2.04 | 57.2 | 0.083 | 44.5 | 0.512 | -176.4 |
| 1900 | 0.772 | 153.3 | 1.93 | 55.5 | 0.087 | 44.7 | 0.513 | -177.1 |
| 2000 | 0.770 | 151.5 | 1.84 | 53.9 | 0.090 | 44.6 | 0.514 | -177.7 |
| 2100 | 0.771 | 149.8 | 1.75 | 52.2 | 0.094 | 44.4 | 0.515 | -178.3 |
| 2200 | 0.773 | 148.1 | 1.67 | 50.6 | 0.097 | 44.2 | 0.516 | -179.0 |
| 2300 | 0.775 | 146.6 | 1.60 | 49.2 | 0.100 | 44.0 | 0.517 | -179.6 |
| 2400 | 0.777 | 145.2 | 1.53 | 47.7 | 0.104 | 43.7 | 0.518 | 179.9 |
| 2500 | 0.777 | 143.7 | 1.48 | 46.2 | 0.108 | 43.3 | 0.519 | 179.4 |
| 2600 | 0.775 | 142.1 | 1.42 | 44.5 | 0.111 | 42.9 | 0.519 | 178.9 |
| 2700 | 0.774 | 140.4 | 1.37 | 42.9 | 0.115 | 42.6 | 0.520 | 178.3 |
| 2800 | 0.775 | 138.8 | 1.32 | 41.3 | 0.118 | 42.0 | 0.521 | 177.8 |
| 2900 | 0.776 | 137.4 | 1.28 | 39.9 | 0.121 | 41.5 | 0.521 | 177.3 |
| 3000 | 0.778 | 136.1 | 1.24 | 38.5 | 0.125 | 40.8 | 0.522 | 176.7 |

S parameter

(V_{CE} = 3.6 V, I_C = 30 mA, Z_o = 50 Ω)

| f (MHz) | S11 | | S21 | | S12 | | S22 | |
|---------|-------|--------|-------|------|-------|------|-------|--------|
| | MAG | ANG | MAG | ANG | MAG | ANG | MAG | ANG |
| 400 | 0.751 | -171.6 | 10.66 | 87.6 | 0.034 | 38.4 | 0.519 | -153.4 |
| 500 | 0.755 | -176.4 | 8.45 | 83.7 | 0.037 | 41.4 | 0.520 | -158.7 |
| 600 | 0.759 | 179.8 | 6.96 | 80.5 | 0.040 | 43.3 | 0.523 | -162.5 |
| 700 | 0.761 | 176.6 | 5.90 | 77.8 | 0.044 | 45.3 | 0.525 | -165.5 |
| 800 | 0.762 | 173.7 | 5.11 | 75.5 | 0.048 | 46.4 | 0.527 | -168.0 |
| 900 | 0.763 | 171.0 | 4.50 | 73.4 | 0.051 | 47.7 | 0.529 | -170.0 |
| 1000 | 0.765 | 168.6 | 4.01 | 71.5 | 0.055 | 48.8 | 0.532 | -171.7 |
| 1100 | 0.766 | 166.5 | 3.63 | 69.8 | 0.059 | 49.5 | 0.534 | -173.2 |
| 1200 | 0.767 | 164.4 | 3.30 | 68.0 | 0.063 | 50.1 | 0.536 | -174.6 |
| 1300 | 0.767 | 162.4 | 3.04 | 66.3 | 0.067 | 50.3 | 0.537 | -175.8 |
| 1400 | 0.767 | 160.3 | 2.82 | 64.5 | 0.071 | 50.5 | 0.539 | -176.9 |
| 1500 | 0.767 | 158.3 | 2.62 | 62.9 | 0.074 | 50.5 | 0.540 | -177.9 |
| 1600 | 0.768 | 156.5 | 2.45 | 61.4 | 0.078 | 50.5 | 0.541 | -178.7 |
| 1700 | 0.772 | 154.8 | 2.30 | 59.8 | 0.082 | 50.3 | 0.543 | -179.5 |
| 1800 | 0.771 | 153.3 | 2.17 | 58.3 | 0.086 | 50.0 | 0.544 | 179.7 |
| 1900 | 0.771 | 151.6 | 2.05 | 56.7 | 0.090 | 49.8 | 0.544 | 179.0 |
| 2000 | 0.769 | 150.0 | 1.95 | 55.1 | 0.093 | 49.4 | 0.545 | 178.4 |
| 2100 | 0.769 | 148.2 | 1.86 | 53.5 | 0.097 | 48.9 | 0.546 | 177.8 |
| 2200 | 0.770 | 146.6 | 1.78 | 52.0 | 0.101 | 48.4 | 0.546 | 177.1 |
| 2300 | 0.773 | 145.1 | 1.70 | 50.6 | 0.105 | 47.9 | 0.546 | 176.5 |
| 2400 | 0.774 | 143.7 | 1.63 | 49.2 | 0.109 | 47.4 | 0.546 | 175.9 |
| 2500 | 0.774 | 142.4 | 1.57 | 47.7 | 0.113 | 46.8 | 0.547 | 175.4 |
| 2600 | 0.772 | 140.8 | 1.51 | 46.1 | 0.116 | 46.0 | 0.547 | 174.8 |
| 2700 | 0.771 | 139.1 | 1.46 | 44.6 | 0.120 | 45.6 | 0.547 | 174.3 |
| 2800 | 0.771 | 137.6 | 1.41 | 43.0 | 0.124 | 44.9 | 0.547 | 173.7 |
| 2900 | 0.772 | 136.2 | 1.37 | 41.7 | 0.128 | 44.1 | 0.547 | 173.2 |
| 3000 | 0.773 | 134.8 | 1.33 | 40.3 | 0.132 | 43.3 | 0.547 | 172.6 |

S parameter

(V_{CE} = 3.6 V, I_C = 50 mA, Z_o = 50 Ω)

| f (MHz) | S11 | | S21 | | S12 | | S22 | |
|---------|-------|--------|-------|------|-------|------|-------|--------|
| | MAG | ANG | MAG | ANG | MAG | ANG | MAG | ANG |
| 400 | 0.758 | -177.0 | 11.23 | 86.1 | 0.029 | 48.2 | 0.548 | -160.4 |
| 500 | 0.761 | 179.2 | 8.87 | 82.7 | 0.033 | 51.3 | 0.552 | -164.7 |
| 600 | 0.764 | 176.1 | 7.30 | 79.9 | 0.037 | 53.2 | 0.556 | -167.8 |
| 700 | 0.766 | 173.4 | 6.19 | 77.5 | 0.041 | 54.8 | 0.559 | -170.2 |
| 800 | 0.766 | 170.8 | 5.36 | 75.4 | 0.046 | 55.7 | 0.561 | -172.3 |
| 900 | 0.766 | 168.4 | 4.72 | 73.5 | 0.050 | 56.3 | 0.564 | -174.0 |
| 1000 | 0.768 | 166.3 | 4.21 | 71.7 | 0.055 | 56.6 | 0.566 | -175.5 |
| 1100 | 0.769 | 164.3 | 3.81 | 70.1 | 0.059 | 57.0 | 0.568 | -176.9 |
| 1200 | 0.769 | 162.3 | 3.47 | 68.5 | 0.063 | 56.9 | 0.570 | -178.1 |
| 1300 | 0.769 | 160.5 | 3.19 | 66.9 | 0.067 | 56.7 | 0.571 | -179.1 |
| 1400 | 0.768 | 158.5 | 2.96 | 65.2 | 0.072 | 56.5 | 0.572 | 179.9 |
| 1500 | 0.768 | 156.6 | 2.75 | 63.7 | 0.076 | 56.0 | 0.573 | 178.9 |
| 1600 | 0.769 | 154.9 | 2.58 | 62.3 | 0.080 | 55.8 | 0.574 | 178.1 |
| 1700 | 0.772 | 153.2 | 2.42 | 60.8 | 0.085 | 55.2 | 0.576 | 177.3 |
| 1800 | 0.772 | 151.7 | 2.28 | 59.3 | 0.089 | 54.6 | 0.576 | 176.6 |
| 1900 | 0.771 | 150.1 | 2.16 | 57.8 | 0.093 | 54.1 | 0.576 | 175.9 |
| 2000 | 0.768 | 148.5 | 2.05 | 56.3 | 0.097 | 53.4 | 0.576 | 175.3 |
| 2100 | 0.769 | 146.8 | 1.96 | 54.8 | 0.101 | 52.7 | 0.577 | 174.7 |
| 2200 | 0.770 | 145.2 | 1.87 | 53.3 | 0.105 | 52.0 | 0.577 | 174.0 |
| 2300 | 0.772 | 143.8 | 1.79 | 52.0 | 0.109 | 51.3 | 0.577 | 173.4 |
| 2400 | 0.773 | 142.4 | 1.72 | 50.7 | 0.113 | 50.5 | 0.576 | 172.8 |
| 2500 | 0.772 | 141.1 | 1.66 | 49.2 | 0.118 | 49.8 | 0.576 | 172.2 |
| 2600 | 0.770 | 139.5 | 1.60 | 47.7 | 0.121 | 48.9 | 0.576 | 171.7 |
| 2700 | 0.769 | 137.9 | 1.54 | 46.2 | 0.126 | 48.2 | 0.575 | 171.1 |
| 2800 | 0.768 | 136.4 | 1.49 | 44.7 | 0.130 | 47.2 | 0.575 | 170.5 |
| 2900 | 0.769 | 135.0 | 1.44 | 43.3 | 0.134 | 46.4 | 0.574 | 169.9 |
| 3000 | 0.771 | 133.7 | 1.40 | 42.0 | 0.138 | 45.4 | 0.574 | 169.3 |

S parameter

 $(V_{CE} = 3.6 \text{ V}, I_C = 70 \text{ mA}, Z_o = 50 \Omega)$

| f (MHz) | S11 | | S21 | | S12 | | S22 | |
|---------|-------|--------|-------|------|-------|------|-------|--------|
| | MAG | ANG | MAG | ANG | MAG | ANG | MAG | ANG |
| 400 | 0.762 | -179.4 | 11.46 | 85.5 | 0.027 | 53.7 | 0.565 | -163.5 |
| 500 | 0.765 | 177.3 | 9.05 | 82.3 | 0.031 | 56.9 | 0.568 | -167.3 |
| 600 | 0.767 | 174.5 | 7.44 | 79.6 | 0.036 | 58.5 | 0.573 | -170.0 |
| 700 | 0.768 | 171.9 | 6.31 | 77.4 | 0.041 | 59.5 | 0.576 | -172.2 |
| 800 | 0.769 | 169.5 | 5.47 | 75.4 | 0.045 | 59.9 | 0.578 | -174.2 |
| 900 | 0.769 | 167.2 | 4.81 | 73.5 | 0.050 | 60.2 | 0.581 | -175.8 |
| 1000 | 0.770 | 165.2 | 4.30 | 71.9 | 0.055 | 60.3 | 0.583 | -177.2 |
| 1100 | 0.771 | 163.3 | 3.88 | 70.3 | 0.059 | 60.4 | 0.585 | -178.4 |
| 1200 | 0.771 | 161.4 | 3.54 | 68.8 | 0.064 | 60.3 | 0.587 | -179.6 |
| 1300 | 0.770 | 159.6 | 3.26 | 67.2 | 0.068 | 59.5 | 0.588 | 179.4 |
| 1400 | 0.770 | 157.7 | 3.02 | 65.6 | 0.072 | 59.2 | 0.589 | 178.4 |
| 1500 | 0.770 | 155.8 | 2.81 | 64.1 | 0.077 | 58.7 | 0.590 | 177.5 |
| 1600 | 0.771 | 154.1 | 2.63 | 62.8 | 0.082 | 58.3 | 0.590 | 176.8 |
| 1700 | 0.773 | 152.5 | 2.48 | 61.3 | 0.086 | 57.4 | 0.592 | 176.0 |
| 1800 | 0.773 | 151.0 | 2.33 | 59.9 | 0.090 | 56.6 | 0.592 | 175.2 |
| 1900 | 0.772 | 149.5 | 2.21 | 58.4 | 0.094 | 56.1 | 0.592 | 174.5 |
| 2000 | 0.769 | 147.8 | 2.10 | 56.9 | 0.099 | 55.2 | 0.592 | 174.0 |
| 2100 | 0.770 | 146.2 | 2.01 | 55.4 | 0.103 | 54.5 | 0.592 | 173.3 |
| 2200 | 0.770 | 144.6 | 1.92 | 54.0 | 0.107 | 53.6 | 0.592 | 172.7 |
| 2300 | 0.772 | 143.1 | 1.84 | 52.7 | 0.111 | 52.9 | 0.592 | 172.1 |
| 2400 | 0.773 | 141.8 | 1.76 | 51.4 | 0.116 | 52.0 | 0.591 | 171.5 |
| 2500 | 0.773 | 140.5 | 1.70 | 50.0 | 0.120 | 51.1 | 0.591 | 170.9 |
| 2600 | 0.770 | 138.9 | 1.63 | 48.5 | 0.124 | 50.1 | 0.590 | 170.3 |
| 2700 | 0.769 | 137.4 | 1.58 | 47.0 | 0.128 | 49.3 | 0.590 | 169.7 |
| 2800 | 0.768 | 135.8 | 1.53 | 45.5 | 0.132 | 48.4 | 0.589 | 169.1 |
| 2900 | 0.769 | 134.4 | 1.48 | 44.2 | 0.136 | 47.4 | 0.588 | 168.5 |
| 3000 | 0.770 | 133.1 | 1.44 | 42.8 | 0.140 | 46.4 | 0.588 | 167.9 |

S parameter

 $(V_{CE} = 3.6 \text{ V}, I_C = 100 \text{ mA}, Z_o = 50 \Omega)$

| f (MHz) | S11 | | S21 | | S12 | | S22 | |
|---------|-------|-------|-------|------|-------|------|-------|--------|
| | MAG | ANG | MAG | ANG | MAG | ANG | MAG | ANG |
| 400 | 0.766 | 178.7 | 11.59 | 85.0 | 0.025 | 59.6 | 0.578 | -165.8 |
| 500 | 0.768 | 175.8 | 9.14 | 82.0 | 0.030 | 61.7 | 0.582 | -169.2 |
| 600 | 0.770 | 173.2 | 7.52 | 79.5 | 0.035 | 62.5 | 0.586 | -171.7 |
| 700 | 0.771 | 170.8 | 6.38 | 77.3 | 0.040 | 63.3 | 0.590 | -173.8 |
| 800 | 0.772 | 168.5 | 5.53 | 75.4 | 0.045 | 63.4 | 0.592 | -175.6 |
| 900 | 0.772 | 166.3 | 4.87 | 73.7 | 0.050 | 63.3 | 0.595 | -177.1 |
| 1000 | 0.772 | 164.3 | 4.35 | 72.1 | 0.055 | 63.3 | 0.597 | -178.4 |
| 1100 | 0.773 | 162.5 | 3.93 | 70.6 | 0.059 | 63.2 | 0.598 | -179.6 |
| 1200 | 0.773 | 160.7 | 3.58 | 69.1 | 0.064 | 62.5 | 0.600 | 179.3 |
| 1300 | 0.772 | 158.9 | 3.30 | 67.6 | 0.069 | 61.8 | 0.601 | 178.3 |
| 1400 | 0.772 | 157.0 | 3.06 | 66.0 | 0.073 | 61.4 | 0.602 | 177.4 |
| 1500 | 0.771 | 155.1 | 2.85 | 64.5 | 0.078 | 60.7 | 0.603 | 176.5 |
| 1600 | 0.772 | 153.5 | 2.67 | 63.2 | 0.082 | 60.0 | 0.603 | 175.8 |
| 1700 | 0.775 | 151.9 | 2.51 | 61.8 | 0.087 | 59.2 | 0.604 | 175.0 |
| 1800 | 0.774 | 150.5 | 2.37 | 60.4 | 0.091 | 58.3 | 0.605 | 174.2 |
| 1900 | 0.773 | 148.9 | 2.24 | 58.9 | 0.096 | 57.7 | 0.604 | 173.5 |
| 2000 | 0.771 | 147.3 | 2.13 | 57.4 | 0.100 | 56.8 | 0.604 | 173.0 |
| 2100 | 0.771 | 145.7 | 2.04 | 56.0 | 0.105 | 55.8 | 0.604 | 172.4 |
| 2200 | 0.771 | 144.1 | 1.95 | 54.5 | 0.109 | 54.9 | 0.604 | 171.7 |
| 2300 | 0.774 | 142.7 | 1.87 | 53.3 | 0.113 | 54.1 | 0.604 | 171.1 |
| 2400 | 0.774 | 141.4 | 1.79 | 52.0 | 0.117 | 53.1 | 0.603 | 170.5 |
| 2500 | 0.774 | 140.0 | 1.72 | 50.6 | 0.122 | 52.3 | 0.603 | 169.9 |
| 2600 | 0.771 | 138.5 | 1.66 | 49.1 | 0.126 | 51.2 | 0.602 | 169.3 |
| 2700 | 0.769 | 136.9 | 1.60 | 47.6 | 0.130 | 50.3 | 0.601 | 168.7 |
| 2800 | 0.769 | 135.4 | 1.55 | 46.1 | 0.135 | 49.4 | 0.601 | 168.1 |
| 2900 | 0.770 | 134.0 | 1.50 | 44.8 | 0.139 | 48.3 | 0.600 | 167.5 |
| 3000 | 0.771 | 132.7 | 1.46 | 43.5 | 0.143 | 47.2 | 0.599 | 166.8 |

S parameter

 $(V_{CE} = 3.6 \text{ V}, I_C = 150 \text{ mA}, Z_o = 50 \Omega)$

| f (MHz) | S11 | | S21 | | S12 | | S22 | |
|---------|-------|-------|-------|------|-------|------|-------|--------|
| | MAG | ANG | MAG | ANG | MAG | ANG | MAG | ANG |
| 400 | 0.770 | 177.2 | 11.57 | 84.7 | 0.025 | 64.9 | 0.589 | -167.6 |
| 500 | 0.773 | 174.5 | 9.13 | 81.8 | 0.030 | 65.7 | 0.594 | -170.7 |
| 600 | 0.775 | 172.2 | 7.50 | 79.4 | 0.035 | 66.4 | 0.598 | -173.0 |
| 700 | 0.776 | 169.9 | 6.37 | 77.4 | 0.040 | 66.9 | 0.601 | -175.0 |
| 800 | 0.776 | 167.7 | 5.52 | 75.5 | 0.045 | 66.2 | 0.603 | -176.7 |
| 900 | 0.775 | 165.6 | 4.87 | 73.9 | 0.050 | 66.1 | 0.606 | -178.1 |
| 1000 | 0.776 | 163.6 | 4.35 | 72.4 | 0.055 | 65.4 | 0.607 | -179.4 |
| 1100 | 0.777 | 161.9 | 3.93 | 70.9 | 0.060 | 65.3 | 0.609 | 179.5 |
| 1200 | 0.777 | 160.1 | 3.59 | 69.4 | 0.065 | 64.4 | 0.610 | 178.4 |
| 1300 | 0.776 | 158.3 | 3.31 | 67.9 | 0.069 | 63.5 | 0.611 | 177.5 |
| 1400 | 0.775 | 156.4 | 3.07 | 66.4 | 0.074 | 63.0 | 0.612 | 176.5 |
| 1500 | 0.775 | 154.6 | 2.86 | 64.9 | 0.079 | 62.3 | 0.612 | 175.7 |
| 1600 | 0.776 | 153.0 | 2.68 | 63.6 | 0.083 | 61.5 | 0.613 | 175.0 |
| 1700 | 0.778 | 151.4 | 2.52 | 62.2 | 0.088 | 60.6 | 0.614 | 174.2 |
| 1800 | 0.778 | 150.0 | 2.38 | 60.8 | 0.092 | 59.6 | 0.614 | 173.4 |
| 1900 | 0.776 | 148.5 | 2.25 | 59.3 | 0.097 | 58.9 | 0.614 | 172.8 |
| 2000 | 0.774 | 146.9 | 2.14 | 57.9 | 0.101 | 57.9 | 0.613 | 172.2 |
| 2100 | 0.774 | 145.2 | 2.05 | 56.4 | 0.106 | 57.0 | 0.614 | 171.6 |
| 2200 | 0.774 | 143.7 | 1.96 | 55.0 | 0.110 | 56.0 | 0.614 | 170.9 |
| 2300 | 0.776 | 142.2 | 1.88 | 53.8 | 0.115 | 55.0 | 0.613 | 170.3 |
| 2400 | 0.777 | 141.0 | 1.80 | 52.5 | 0.119 | 54.1 | 0.612 | 169.7 |
| 2500 | 0.776 | 139.6 | 1.73 | 51.1 | 0.123 | 53.2 | 0.612 | 169.1 |
| 2600 | 0.774 | 138.1 | 1.67 | 49.6 | 0.128 | 52.1 | 0.611 | 168.5 |
| 2700 | 0.772 | 136.5 | 1.61 | 48.1 | 0.132 | 51.1 | 0.610 | 167.9 |
| 2800 | 0.771 | 135.0 | 1.56 | 46.6 | 0.136 | 50.1 | 0.610 | 167.3 |
| 2900 | 0.772 | 133.6 | 1.51 | 45.3 | 0.141 | 49.1 | 0.608 | 166.7 |
| 3000 | 0.773 | 132.3 | 1.47 | 44.0 | 0.145 | 48.0 | 0.608 | 166.0 |

S parameter

(V_{CE} = 3.6 V, I_C = 200 mA, Z_o = 50 Ω)

| f (MHz) | S11 | | S21 | | S12 | | S22 | |
|---------|-------|-------|-------|------|-------|------|-------|--------|
| | MAG | ANG | MAG | ANG | MAG | ANG | MAG | ANG |
| 400 | 0.776 | 176.4 | 11.40 | 84.6 | 0.025 | 67.7 | 0.594 | -168.5 |
| 500 | 0.777 | 173.9 | 8.99 | 81.8 | 0.030 | 67.8 | 0.599 | -171.5 |
| 600 | 0.780 | 171.6 | 7.40 | 79.5 | 0.035 | 68.3 | 0.603 | -173.7 |
| 700 | 0.780 | 169.4 | 6.28 | 77.5 | 0.040 | 68.2 | 0.606 | -175.6 |
| 800 | 0.780 | 167.2 | 5.45 | 75.7 | 0.045 | 67.8 | 0.608 | -177.3 |
| 900 | 0.780 | 165.2 | 4.81 | 74.1 | 0.050 | 67.1 | 0.610 | -178.7 |
| 1000 | 0.780 | 163.3 | 4.30 | 72.6 | 0.055 | 66.6 | 0.612 | -180.0 |
| 1100 | 0.781 | 161.5 | 3.89 | 71.1 | 0.060 | 66.4 | 0.613 | 178.9 |
| 1200 | 0.781 | 159.8 | 3.55 | 69.6 | 0.065 | 65.6 | 0.614 | 177.9 |
| 1300 | 0.780 | 158.0 | 3.27 | 68.1 | 0.070 | 64.6 | 0.615 | 177.0 |
| 1400 | 0.779 | 156.2 | 3.04 | 66.6 | 0.074 | 63.9 | 0.616 | 176.1 |
| 1500 | 0.779 | 154.4 | 2.83 | 65.1 | 0.079 | 63.1 | 0.616 | 175.2 |
| 1600 | 0.780 | 152.7 | 2.65 | 63.8 | 0.084 | 62.3 | 0.617 | 174.6 |
| 1700 | 0.782 | 151.2 | 2.50 | 62.4 | 0.089 | 61.2 | 0.619 | 173.8 |
| 1800 | 0.781 | 149.8 | 2.36 | 61.0 | 0.093 | 60.4 | 0.618 | 173.0 |
| 1900 | 0.780 | 148.3 | 2.23 | 59.5 | 0.097 | 59.5 | 0.618 | 172.4 |
| 2000 | 0.777 | 146.7 | 2.12 | 58.1 | 0.102 | 58.5 | 0.617 | 171.8 |
| 2100 | 0.778 | 145.0 | 2.03 | 56.6 | 0.107 | 57.5 | 0.617 | 171.2 |
| 2200 | 0.778 | 143.5 | 1.94 | 55.2 | 0.111 | 56.6 | 0.617 | 170.5 |
| 2300 | 0.780 | 142.0 | 1.86 | 53.9 | 0.115 | 55.7 | 0.617 | 169.9 |
| 2400 | 0.780 | 140.7 | 1.79 | 52.6 | 0.120 | 54.6 | 0.616 | 169.3 |
| 2500 | 0.780 | 139.4 | 1.72 | 51.2 | 0.124 | 53.6 | 0.615 | 168.8 |
| 2600 | 0.777 | 137.9 | 1.66 | 49.7 | 0.128 | 52.6 | 0.615 | 168.1 |
| 2700 | 0.776 | 136.3 | 1.60 | 48.2 | 0.133 | 51.5 | 0.614 | 167.5 |
| 2800 | 0.775 | 134.8 | 1.55 | 46.8 | 0.137 | 50.6 | 0.613 | 166.9 |
| 2900 | 0.776 | 133.4 | 1.50 | 45.5 | 0.142 | 49.5 | 0.612 | 166.3 |
| 3000 | 0.777 | 132.1 | 1.46 | 44.2 | 0.146 | 48.4 | 0.611 | 165.6 |

S parameter

 $(V_{CE} = 3.6 \text{ V}, I_C = 250 \text{ mA}, Z_o = 50 \Omega)$

| f (MHz) | S11 | | S21 | | S12 | | S22 | |
|---------|-------|--------|-------|------|-------|------|-------|--------|
| | MAG | ANG | MAG | ANG | MAG | ANG | MAG | ANG |
| 400 | 0.749 | -169.0 | 10.38 | 88.4 | 0.037 | 34.8 | 0.508 | -149.8 |
| 500 | 0.753 | -174.3 | 8.24 | 84.2 | 0.040 | 37.6 | 0.507 | -155.7 |
| 600 | 0.757 | -178.4 | 6.79 | 80.9 | 0.043 | 39.3 | 0.509 | -159.9 |
| 700 | 0.759 | 178.1 | 5.76 | 78.1 | 0.046 | 41.2 | 0.511 | -163.1 |
| 800 | 0.761 | 175.0 | 4.99 | 75.6 | 0.049 | 42.9 | 0.513 | -165.8 |
| 900 | 0.762 | 172.3 | 4.39 | 73.4 | 0.052 | 44.1 | 0.515 | -168.0 |
| 1000 | 0.763 | 169.7 | 3.92 | 71.5 | 0.056 | 45.2 | 0.518 | -169.8 |
| 1100 | 0.765 | 167.5 | 3.54 | 69.7 | 0.060 | 46.2 | 0.519 | -171.4 |
| 1200 | 0.766 | 165.4 | 3.23 | 67.8 | 0.063 | 46.8 | 0.521 | -172.9 |
| 1300 | 0.766 | 163.3 | 2.97 | 66.0 | 0.067 | 47.0 | 0.523 | -174.1 |
| 1400 | 0.766 | 161.2 | 2.75 | 64.3 | 0.070 | 47.5 | 0.525 | -175.2 |
| 1500 | 0.766 | 159.1 | 2.56 | 62.6 | 0.074 | 47.8 | 0.526 | -176.2 |
| 1600 | 0.768 | 157.3 | 2.39 | 61.0 | 0.078 | 48.0 | 0.527 | -177.1 |
| 1700 | 0.772 | 155.6 | 2.25 | 59.4 | 0.081 | 47.9 | 0.529 | -177.9 |
| 1800 | 0.772 | 154.0 | 2.12 | 57.8 | 0.085 | 47.8 | 0.530 | -178.8 |
| 1900 | 0.771 | 152.3 | 2.00 | 56.2 | 0.088 | 47.6 | 0.531 | -179.5 |
| 2000 | 0.769 | 150.6 | 1.90 | 54.6 | 0.092 | 47.4 | 0.531 | 179.9 |
| 2100 | 0.770 | 148.9 | 1.82 | 53.0 | 0.096 | 47.1 | 0.532 | 179.3 |
| 2200 | 0.771 | 147.2 | 1.73 | 51.4 | 0.100 | 46.6 | 0.533 | 178.7 |
| 2300 | 0.774 | 145.7 | 1.66 | 50.0 | 0.103 | 46.4 | 0.534 | 178.1 |
| 2400 | 0.775 | 144.3 | 1.59 | 48.6 | 0.107 | 45.9 | 0.534 | 177.5 |
| 2500 | 0.775 | 142.9 | 1.53 | 47.1 | 0.110 | 45.4 | 0.534 | 177.0 |
| 2600 | 0.773 | 141.3 | 1.47 | 45.5 | 0.114 | 44.7 | 0.535 | 176.4 |
| 2700 | 0.772 | 139.7 | 1.42 | 43.9 | 0.118 | 44.3 | 0.535 | 175.9 |
| 2800 | 0.772 | 138.1 | 1.37 | 42.3 | 0.121 | 43.7 | 0.535 | 175.4 |
| 2900 | 0.774 | 136.7 | 1.33 | 41.0 | 0.125 | 43.1 | 0.535 | 174.8 |
| 3000 | 0.775 | 135.3 | 1.29 | 39.5 | 0.129 | 42.3 | 0.535 | 174.3 |

Package Dimensions

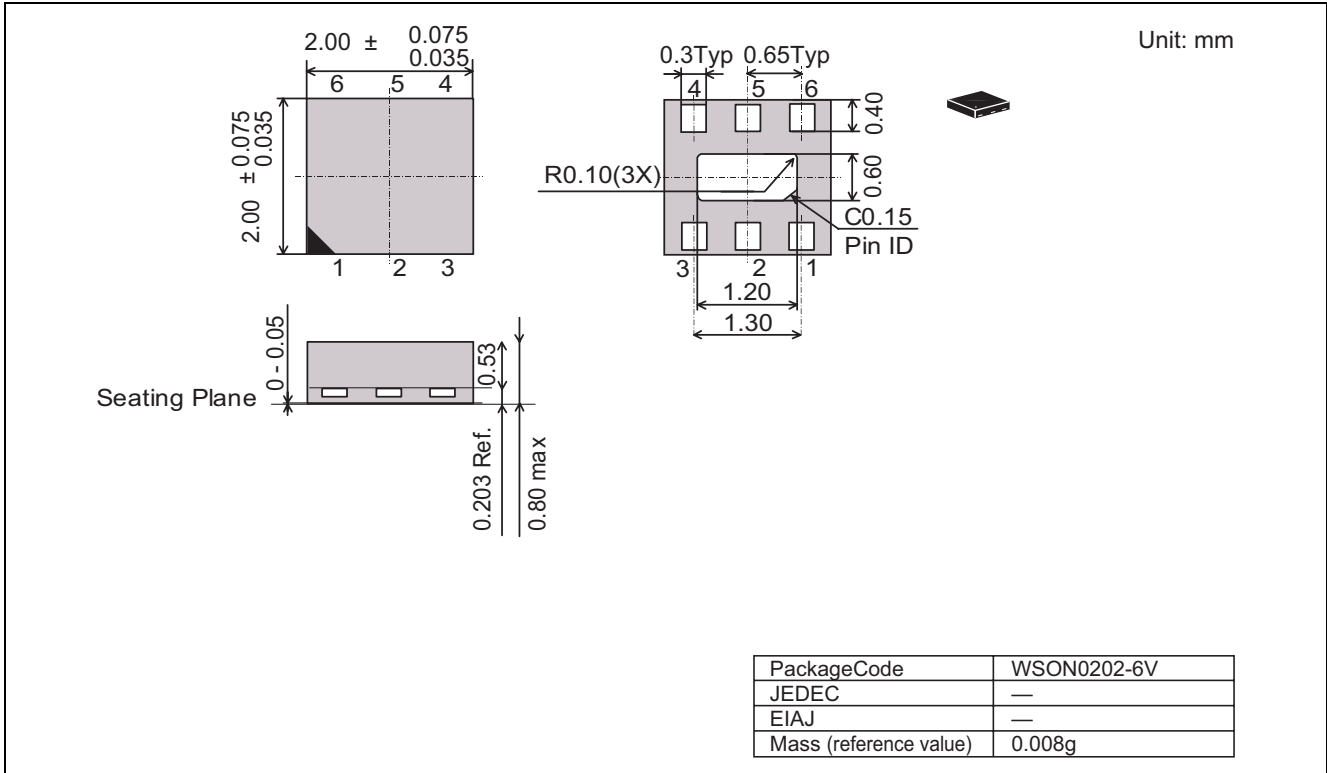

Ordering Information

| Part Name | Quantity | Shipping Container |
|-----------|----------|--------------------|
| 2SC5945TR | 3000 | φ178 taping |

Note: Therefore especially small contact area of terminal, miss contact may occur if inadequate soldering condition is applied.

Contact Renesas sales office for any question regarding recommended soldering condition of Renesas.

Renesas Technology Corp. Sales Strategic Planning Div. Nippon Bldg., 2-6-2, Ohte-machi, Chiyoda-ku, Tokyo 100-0004, Japan

Keep safety first in your circuit designs!

1. Renesas Technology Corp. puts the maximum effort into making semiconductor products better and more reliable, but there is always the possibility that trouble may occur with them. Trouble with semiconductors may lead to personal injury, fire or property damage.
Remember to give due consideration to safety when making your circuit designs, with appropriate measures such as (i) placement of substitutive, auxiliary circuits, (ii) use of nonflammable material or (iii) prevention against any malfunction or mishap.

Notes regarding these materials

1. These materials are intended as a reference to assist our customers in the selection of the Renesas Technology Corp. product best suited to the customer's application; they do not convey any license under any intellectual property rights, or any other rights, belonging to Renesas Technology Corp. or a third party.
 2. Renesas Technology Corp. assumes no responsibility for any damage, or infringement of any third-party's rights, originating in the use of any product data, diagrams, charts, programs, algorithms, or circuit application examples contained in these materials.
 3. All information contained in these materials, including product data, diagrams, charts, programs and algorithms represents information on products at the time of publication of these materials, and are subject to change by Renesas Technology Corp. without notice due to product improvements or other reasons. It is therefore recommended that customers contact Renesas Technology Corp. or an authorized Renesas Technology Corp. product distributor for the latest product information before purchasing a product listed herein.
The information described here may contain technical inaccuracies or typographical errors.
Renesas Technology Corp. assumes no responsibility for any damage, liability, or other loss rising from these inaccuracies or errors.
Please also pay attention to information published by Renesas Technology Corp. by various means, including the Renesas Technology Corp. Semiconductor home page (<http://www.renesas.com>).
 4. When using any or all of the information contained in these materials, including product data, diagrams, charts, programs, and algorithms, please be sure to evaluate all information as a total system before making a final decision on the applicability of the information and products. Renesas Technology Corp. assumes no responsibility for any damage, liability or other loss resulting from the information contained herein.
 5. Renesas Technology Corp. semiconductors are not designed or manufactured for use in a device or system that is used under circumstances in which human life is potentially at stake. Please contact Renesas Technology Corp. or an authorized Renesas Technology Corp. product distributor when considering the use of a product contained herein for any specific purposes, such as apparatus or systems for transportation, vehicular, medical, aerospace, nuclear, or undersea repeater use.
 6. The prior written approval of Renesas Technology Corp. is necessary to reprint or reproduce in whole or in part these materials.
 7. If these products or technologies are subject to the Japanese export control restrictions, they must be exported under a license from the Japanese government and cannot be imported into a country other than the approved destination.
Any diversion or reexport contrary to the export control laws and regulations of Japan and/or the country of destination is prohibited.
 8. Please contact Renesas Technology Corp. for further details on these materials or the products contained therein.
-



RENESAS SALES OFFICES

<http://www.renesas.com>

Refer to "<http://www.renesas.com/en/network>" for the latest and detailed information.

Renesas Technology America, Inc.

450 Holger Way, San Jose, CA 95134-1368, U.S.A
Tel: <1> (408) 382-7500, Fax: <1> (408) 382-7501

Renesas Technology Europe Limited

Dukes Meadow, Millboard Road, Bourne End, Buckinghamshire, SL8 5FH, U.K.
Tel: <44> (1628) 585-100, Fax: <44> (1628) 585-900

Renesas Technology Hong Kong Ltd.

7th Floor, North Tower, World Finance Centre, Harbour City, 1 Canton Road, Tsimshatsui, Kowloon, Hong Kong
Tel: <852> 2265-6688, Fax: <852> 2730-6071

Renesas Technology Taiwan Co., Ltd.

10th Floor, No.99, Fushing North Road, Taipei, Taiwan
Tel: <886> (2) 2715-2888, Fax: <886> (2) 2713-2999

Renesas Technology (Shanghai) Co., Ltd.

Unit2607 Ruijing Building, No.205 Maoming Road (S), Shanghai 200020, China
Tel: <86> (21) 6472-1001, Fax: <86> (21) 6415-2952

Renesas Technology Singapore Pte. Ltd.

1 Harbour Front Avenue, #06-10, Keppel Bay Tower, Singapore 098632
Tel: <65> 6213-0200, Fax: <65> 6278-8001



LittleDiode supplies new, hard to find or obsolete electronic components and semiconductors all over the world.

With over two million different components listed you are sure to find the part you need.

Feel free to visit us today at our online store:

LittleDiode.com

Looking forward to providing you with the best possible service.