

DISCRIPTION

2SC3628 is a silicon NPN epitaxial planar type transistor designed for RF power amplifiers in VHF band mobile radio applications.

FEATURES

- High power gain: $G_{pe} \geq 13.8\text{dB}$
@ $V_{CC} = 13.5\text{V}$, $P_O = 6\text{W}$, $f = 175\text{MHz}$
- Emitter ballasted construction and gold metallization for high reliability and good performances.
- Low thermal resistance ceramic package with flange.
- Ability of withstanding more than 20:1 load VSWR when operated at $V_{CC} = 15.2\text{V}$, $P_O = 6\text{W}$, $f = 175\text{MHz}$.

APPLICATION

4 to 5 watts output power amplifiers in VHF band mobile radio applications.

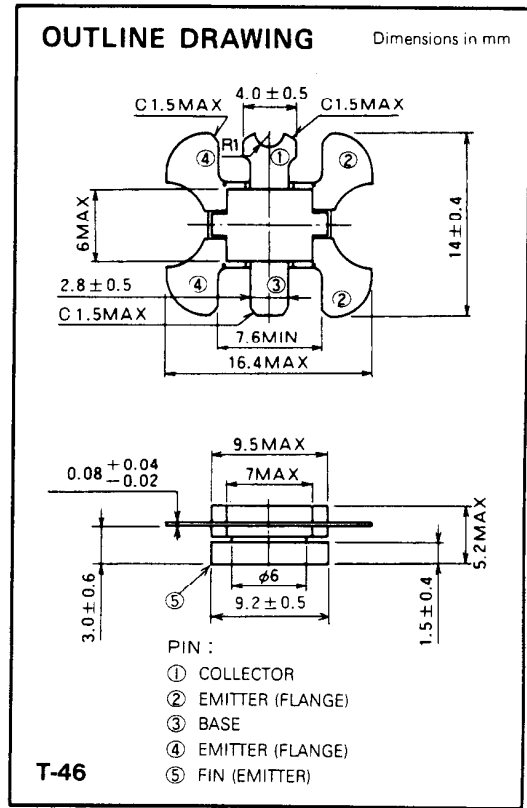

ABSOLUTE MAXIMUM RATINGS ($T_C = 25^\circ\text{C}$ unless otherwise specified)

Symbol	Parameter	Conditions	Ratings	Unit
V_{CBO}	Collector to base voltage		35	V
V_{EBO}	Emitter to base voltage		4	V
V_{CEO}	Collector to emitter voltage	$R_{BE} = \infty$	17	V
I_C	Collector current		2	A
P_C	Collector dissipation	$T_a = 25^\circ\text{C}$	2	W
		$T_C = 25^\circ\text{C}$	20	W
T_j	Junction temperature		175	$^\circ\text{C}$
T_{stg}	Storage temperature		-55 to 175	$^\circ\text{C}$
R_{th-a}	Thermal resistance	Junction to ambient	75	$^\circ\text{C/W}$
R_{th-c}		Junction to case	7.5	$^\circ\text{C/W}$

Note. Above parameters are guaranteed independently.

ELECTRICAL CHARACTERISTICS ($T_C = 25^\circ\text{C}$ unless otherwise specified)

Symbol	Parameter	Test conditions	Limits			Unit
			Min	Typ	Max	
$V_{(BR)EBO}$	Emitter to base breakdown voltage	$I_E = 5\text{mA}$, $I_C = 0$	4			V
$V_{(BR)CBO}$	Collector to base breakdown voltage	$I_C = 10\text{mA}$, $I_B = 0$	35			V
$V_{(BR)CEO}$	Collector to emitter breakdown voltage	$I_C = 50\text{mA}$, $R_{BE} = \infty$	17			V
I_{CBO}	Collector cutoff current	$V_{CB} = 25\text{V}$, $I_E = 0$			500	μA
I_{EBO}	Emitter cutoff current	$V_{EB} = 3\text{V}$, $I_C = 0$			500	μA
h_{FE}	DC forward current gain *	$V_{CE} = 10\text{V}$, $I_C = 0.1\text{A}$	10	50	180	—
P_O	Output power	$V_{CC} = 13.5\text{V}$, $P_{in} = 0.25\text{W}$, $f = 175\text{MHz}$	6	7.5		W
η_C	Collector efficiency		60	65		%

Note. * Pulse test, $P_w = 150\mu\text{s}$, duty = 5%.

Above parameters, ratings, limits and conditions are subject to change.

TEST CIRCUIT

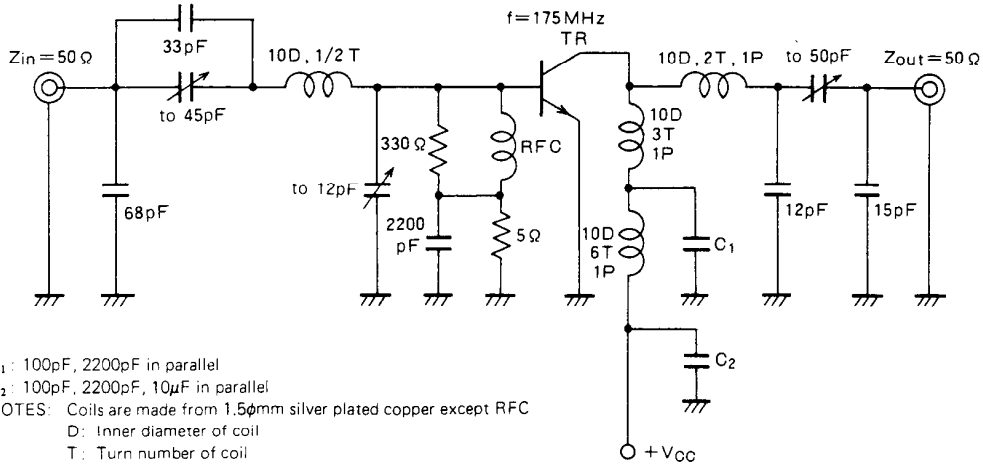

C_1 : 100pF, 2200pF in parallel
 C_2 : 100pF, 2200pF, 10μF in parallel
 NOTES: Coils are made from 1.5φmm silver plated copper except RFC
 D: Inner diameter of coil
 T: Turn number of coil
 P: Pitch of coil
 Dimension in milli-meter

TYPICAL PERFORMANCE DATE

COLLECTOR DISSIPATION VS. AMBIENT TEMPERATURE

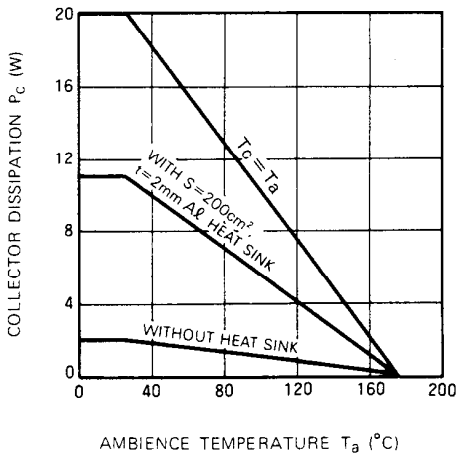

COLLECTOR CURRENT VS. COLLECTOR TO EMITTER VOLTAGE

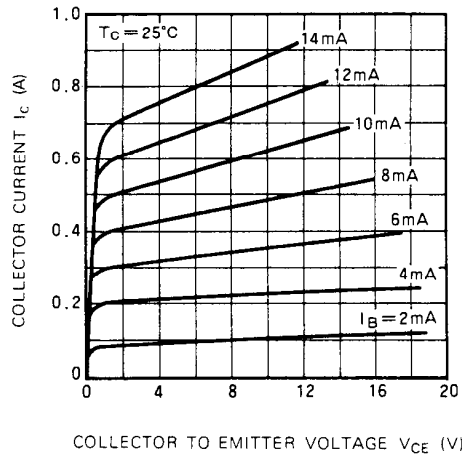

DC CURRENT GAIN VS. COLLECTOR CURRENT

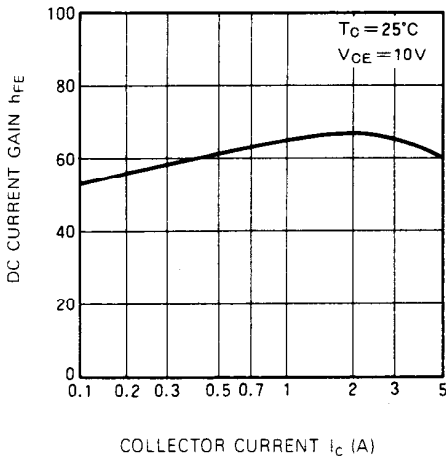

COLLECTOR TO EMITTER BREAKDOWN VOLTAGE VS. BASE TO EMITTER RESISTANCE

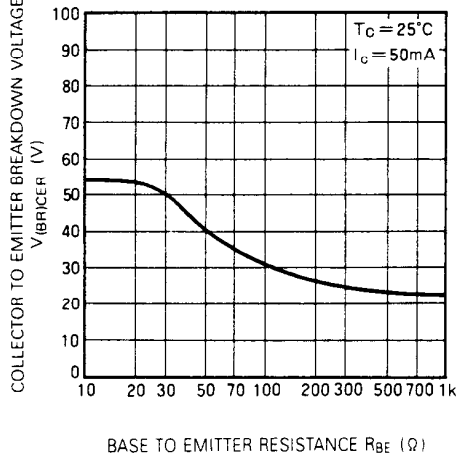

NPN EPITAXIAL PLANAR TYPE

COLLECTOR OUTPUT CAPACITANCE VS. COLLECTOR TO BASE VOLTAGE

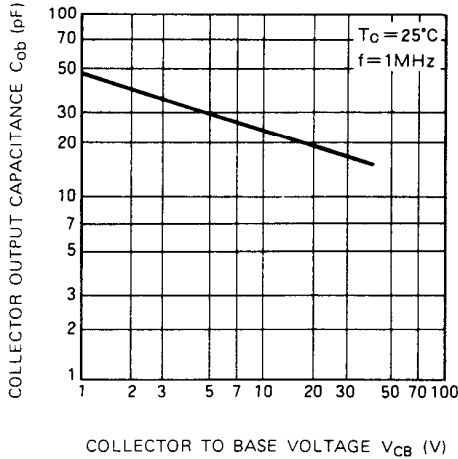

OUTPUT POWER, COLLECTOR EFFICIENCY VS. INPUT POWER

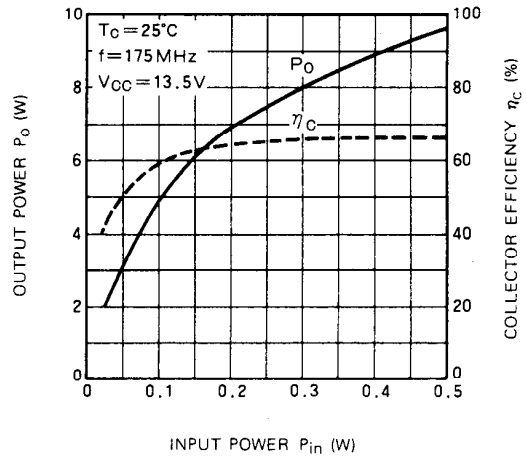

OUTPUT POWER VS. COLLECTOR SUPPLY VOLTAGE

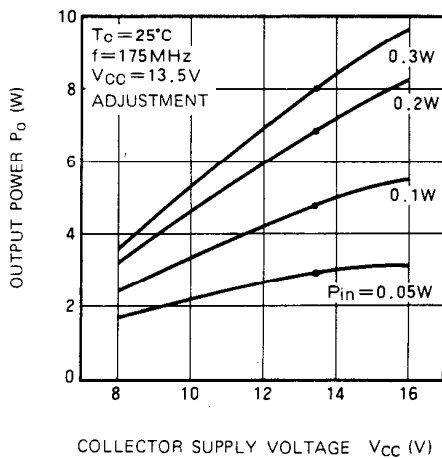

PRECAUTIONS FOR MOUNTING HIGH-FREQUENCY HIGH-OUTPUT TRANSISTOR FOR MOBILE RADIO EQUIPMENT

When mounting high-frequency, high-output transistors for mobile radio equipment (flange screw fastening part cut package), care should be taken to the following points.

1. When mounting the device to the heat sink, silicon compound should be applied to the heat sink and device heat radiating fin and apply the device to the heat sink using a proper fastening tool.
2. If the device is soldered directly to heat sink, excessive thermal stress will result in deteriorating the reliability. Do not use this mounting method.
3. Care should be taken, if the device is applied to the heat sink, the force of soldering the leads to the printed circuit board results in continual mechanical stress, deteriorating the reliability and performance of the system.
4. Refer to Mitsubishi's DATABOOK or manuals for transistors, small-signal diodes and integrated circuit modules for mounting and handling of the device.



LittleDiode supplies new, hard to find or obsolete electronic components and semiconductors all over the world.

With over two million different components listed you are sure to find the part you need.

Feel free to visit us today at our online store:

LittleDiode.com

Looking forward to providing you with the best possible service.