

STEREO AMPLIFIER AND DC VOLUME CONTROL FOR TV

- STEREO CIRCUIT
- DC VOLUME CONTROL
- 12dB MAXIMUM GAIN

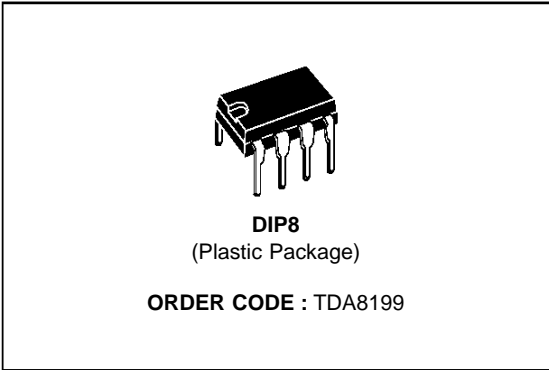

DESCRIPTION

The TDA8199 is a monolithic integrated circuit in DIP8 package intended for TV applications.

PIN CONNECTIONS

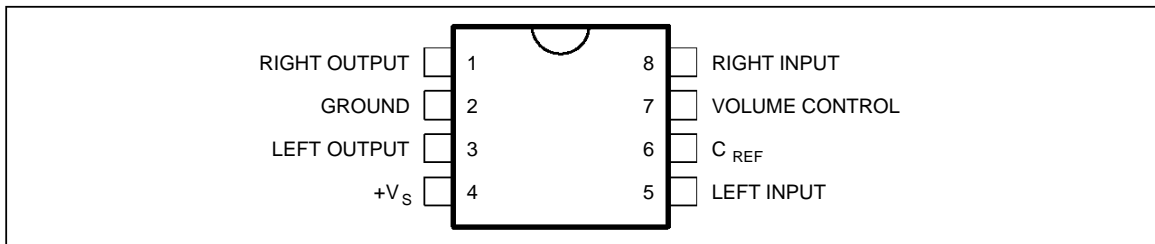

8199-01.EPS

BLOCK DIAGRAM

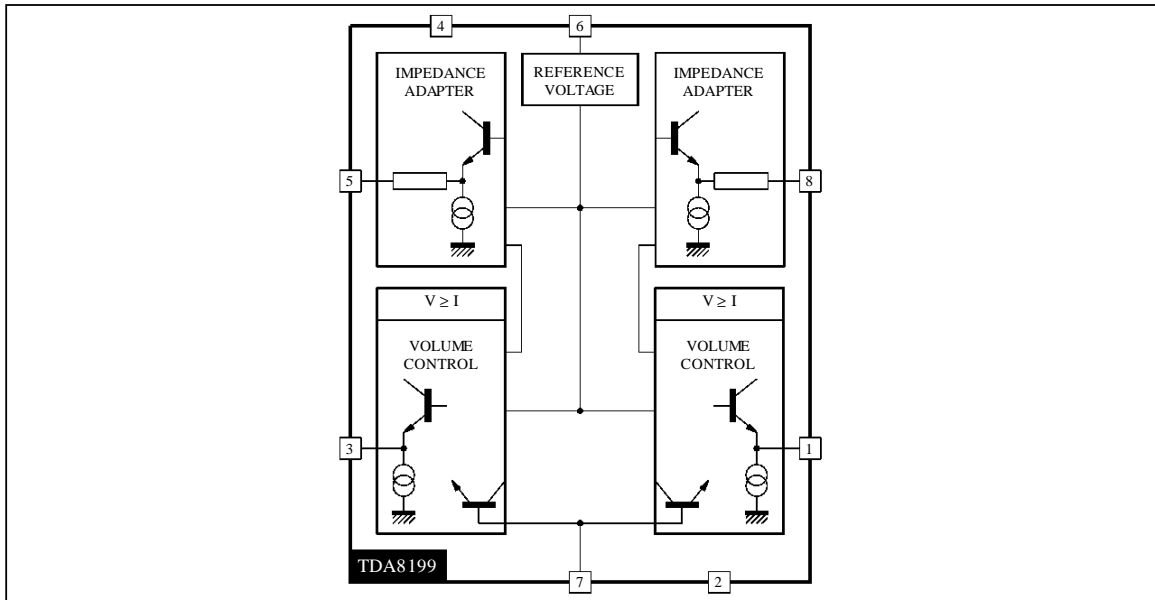

8199-02.EPS

ABSOLUTE MAXIMUM RATINGS

Symbol	Parameter	Value	Unit
V _S	Supply Voltage	16	V
T _{stg}	Storage Temperature	- 55, + 125	°C
T _{oper}	Operating Ambient Temperature	0, + 70	°C

8199-01.TBL

ELECTRICAL CHARACTERISTICS

Measured according to the following conditions : T_{amb} = 25°C, V_S = +12V (unless otherwise specified)

Symbol	Parameter	Min.	Typ.	Max.	Unit
V _S	Supply Voltage	10.8	12	13.2	V
I _S	Supply Current (V _{IN} = 0, V _C = 0.5V)		21	28	mA
V _{REF}	Reference Voltage		6.9		V
V _i	Audio Input Amplitude		0.125	0.5	V _{RMS}
THD1	Distortion for V _i = 0.25 V _{RMS} at Max. Volume		0.35	1	%
THD2	Distortion for V _O = 2 V _{RMS}			5	%
ΔK	DC Volume Control Range at V _i = 0.5 V _{RMS}	70	90		dB
K _{min}	Output/Input Gain for Max. Volume (V _C = 5V)		12		dB
dK	Gain Difference between Channels at V _C = 5V		0		dB
C _C	Crosstalk between Channels (R _L > 10kΩ and F = 1kHz)		70		dB
R _I	Audio Input Resistance		22		kΩ
R _O	Audio Output Resistance		0.3	1	kΩ
	Output Noise Level at V _C = 5V (weighted curve : DIN45405)		300		μV _{RMS}
	Volume Control Input Current (Pin 7) at V _C = 0V		- 25		μA
	Volume Thermal Stability (K = 30dB, 0 < T _{amb} < 60°C)		0.04		dB/°C

8199-02.TBL

Figure 1 : Gain versus Volume Control

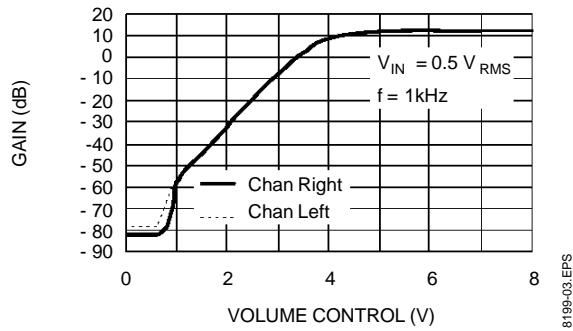

8199-03.EPS

Figure 2 : Distortion versus Volume Control

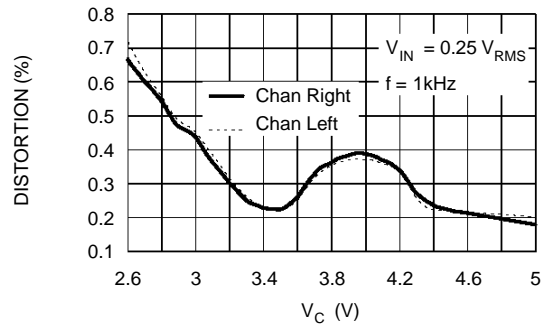

8199-04.EPS

Figure 3 : Distortion Rate versus Voltage Input

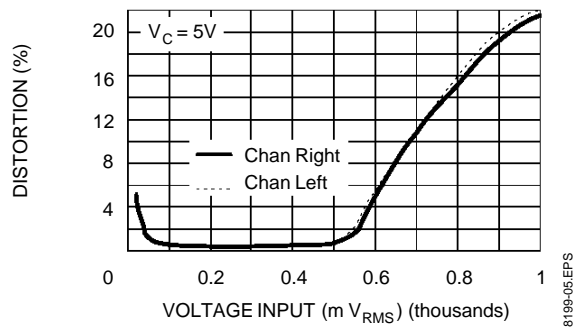

8199-05.EPS

Figure 4 : Supply Voltage Rejection

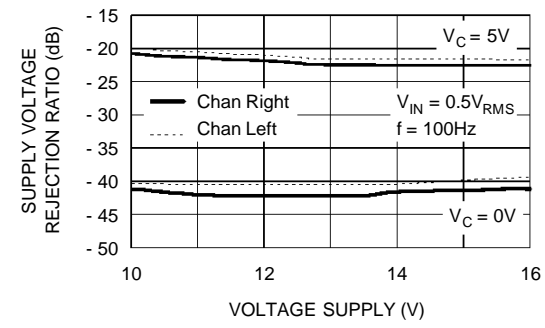

8199-06.EPS

APPLICATION DIAGRAM

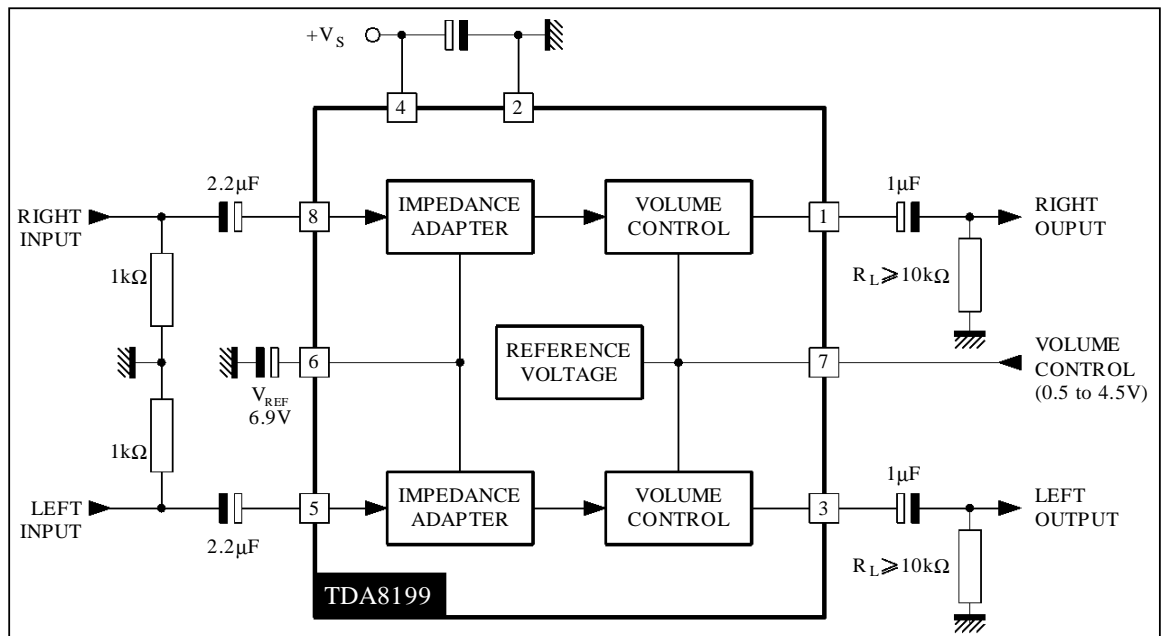

8199-07.EPS

TDA8199

PACKAGE MECHANICAL DATA 8 PINS - PLASTIC DIP

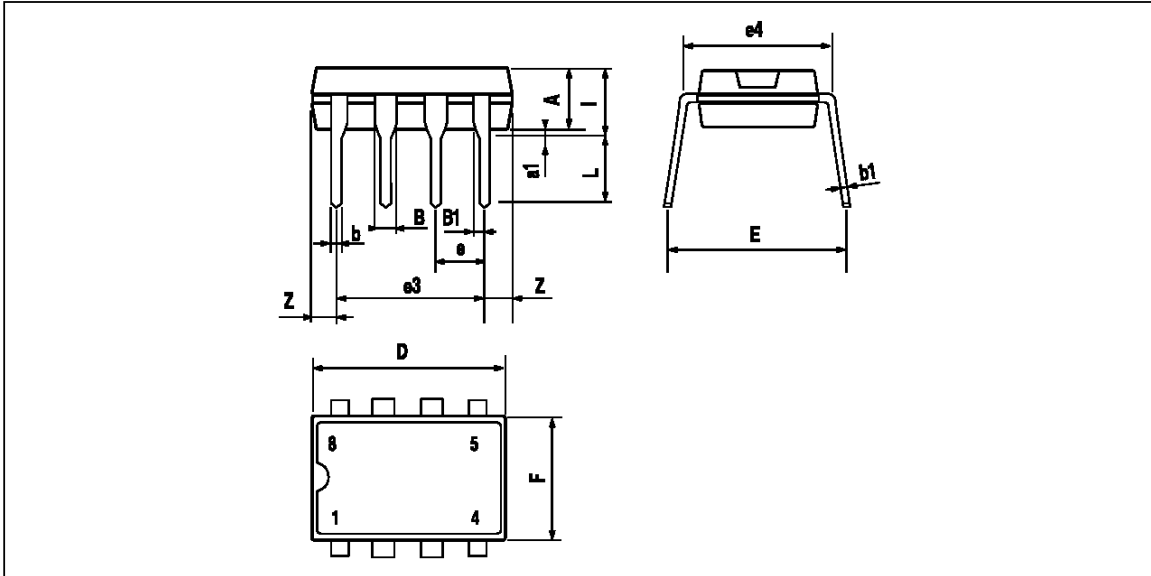

Dimensions	Millimeters			Inches		
	Min.	Typ.	Max.	Min.	Typ.	Max.
A		3.32			0.131	
a1	0.51			0.020		
B	1.15		1.65	0.045		0.065
b	0.356		0.55	0.014		0.022
b1	0.204		0.304	0.008		0.012
D			10.92			0.430
E	7.95		9.75	0.313		0.384
e		2.54			0.100	
e3		7.62			0.300	
e4		7.62			0.300	
F			6.6			0.260
l			5.08			0.200
L	3.18		3.81	0.125		0.150
Z			1.52			0.060

Information furnished is believed to be accurate and reliable. However, SGS-THOMSON Microelectronics assumes no responsibility for the consequences of use of such information nor for any infringement of patents or other rights of third parties which may result from its use. No licence is granted by implication or otherwise under any patent or patent rights of SGS-THOMSON Microelectronics. Specifications mentioned in this publication are subject to change without notice. This publication supersedes and replaces all information previously supplied. SGS-THOMSON Microelectronics products are not authorized for use as critical components in life support devices or systems without express written approval of SGS-THOMSON Microelectronics.

© 1996 SGS-THOMSON Microelectronics - All Rights Reserved

Purchase of I²C Components of SGS-THOMSON Microelectronics, conveys a license under the Philips I²C Patent. Rights to use these components in a I²C system, is granted provided that the system conforms to the I²C Standard Specifications as defined by Philips.

SGS-THOMSON Microelectronics GROUP OF COMPANIES

Australia - Brazil - Canada - China - France - Germany - Hong Kong - Italy - Japan - Korea - Malaysia - Malta - Morocco
The Netherlands - Singapore - Spain - Sweden - Switzerland - Taiwan - Thailand - United Kingdom - U.S.A.