

**HIGH SPEED SWITCHING
NPN SILICON EPITAXIAL TRANSISTOR
MINI MOLD**

PACKAGE DIMENSIONS

in millimeters

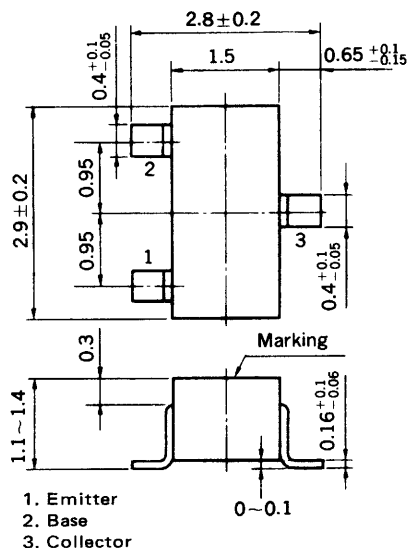

FEATURE

- High Speed : $t_{stg} = 20 \text{ ns MAX.}$

ABSOLUTE MAXIMUM RATINGS

Maximum Voltages and Current ($T_a = 25^\circ\text{C}$)

Collector to Base Voltage	V_{CBO}	40	V
Collector to Emitter Voltage	V_{CEO}	20	V
Emitter to Base Voltage	V_{EBO}	5	V
Collector Current (DC)	I_C	200	mA

Maximum Power Dissipation

Total Power Dissipation at 25°C Ambient Temperature	P_T	200	mW
--	-------	-----	----

Maximum Temperatures

Junction Temperature	T_j	150	$^\circ\text{C}$
Storage Temperature Range	T_{stg}	-55 to +150	$^\circ\text{C}$

ELECTRICAL CHARACTERISTICS ($T_a = 25^\circ\text{C}$)

CHARACTERISTIC	SYMBOL	MIN.	TYP.	MAX.	UNIT	TEST CONDITIONS
Collector Cutoff Current	I_{CBO}			100	nA	$V_{CB} = 30 \text{ V}, I_E = 0$
Emitter Cutoff Current	I_{EBO}			100	nA	$V_{EB} = 4.0 \text{ V}, I_C = 0$
DC Current Gain	h_{FE1}^*	40	80	180		$V_{CE} = 0.5 \text{ V}, I_C = 1.0 \text{ mA}$
Collector Saturation Voltage	$V_{CE(sat)}^*$		0.13	0.25	V	$I_C = 10 \text{ mA}, I_B = 1.0 \text{ mA}$
Base Saturation Voltage	$V_{BE(sat)}^*$		0.74	0.85	V	$I_C = 10 \text{ mA}, I_B = 1.0 \text{ mA}$
Gain Bandwidth Product	f_T	200	500		MHz	$V_{CE} = 10 \text{ V}, I_E = -10 \text{ mA}$
Output Capacitance	C_{ob}		3.0	6.0	pF	$V_{CB} = 10 \text{ V}, I_E = 0, f = 1.0 \text{ MHz}$
Turn-on Time	t_{on}		12	20	ns	See Test Circuit
Storage Time	t_{stg}		7	20	ns	
Turn-off Time	t_{off}		18	40	ns	

* Pulsed: $PW \leq 350 \mu\text{s}$, Duty Cycle $\leq 2\%$

h_{FE} Classification

Marking	B2	B3	B4
h_{FE}	40 to 80	60 to 120	90 to 180

TYPICAL CHARACTERISTICS ($T_a = 25^\circ\text{C}$)

COLLECTOR CURRENT vs. BASE TO EMITTER VOLTAGE

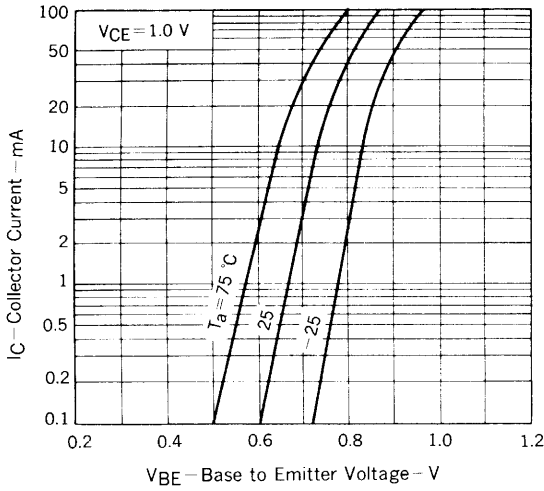

COLLECTOR CURRENT vs. COLLECTOR TO EMITTER VOLTAGE

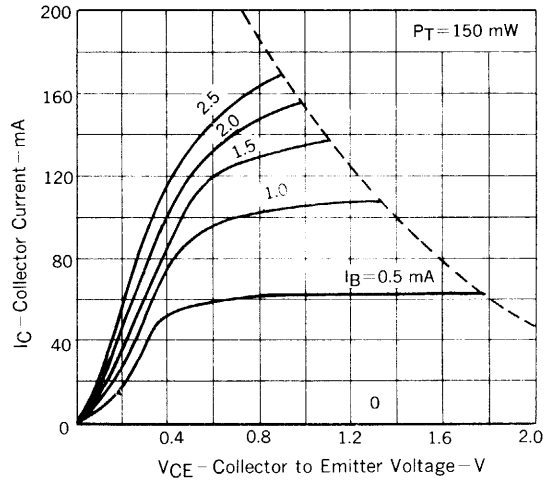

COLLECTOR CURRENT vs. COLLECTOR TO EMITTER VOLTAGE

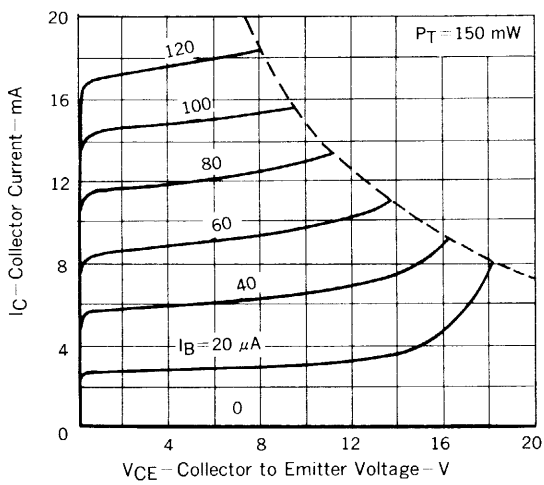

DC CURRENT GAIN vs. COLLECTOR CURRENT

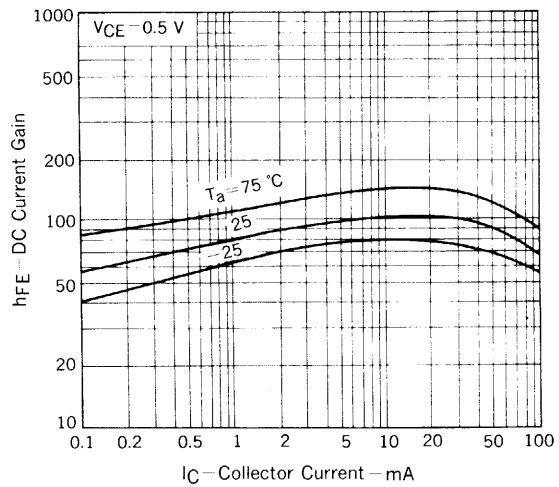

BASE AND COLLECTOR SATURATION VOLTAGE vs. COLLECTOR CURRENT

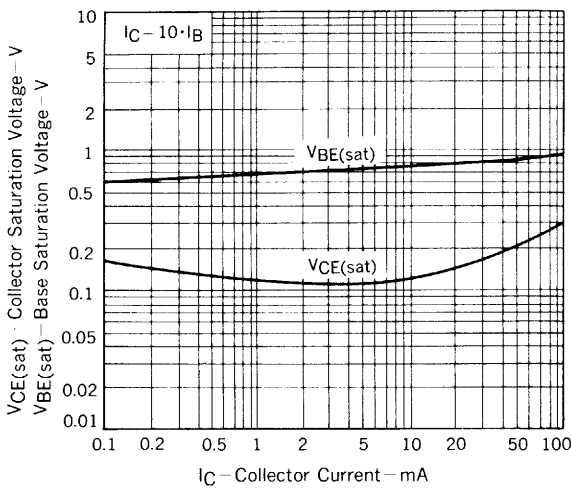

COLLECTOR TO EMITTER VOLTAGE vs. BASE EMITTER RESISTANCE

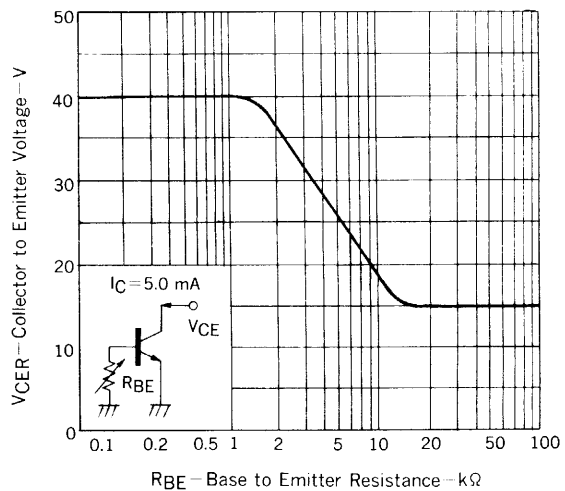

GAIN BANDWIDTH PRODUCT vs. EMITTER CURRENT

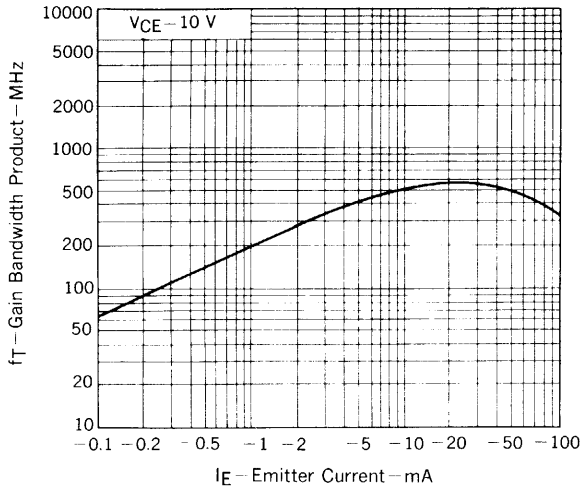

INPUT AND OUTPUT CAPACITANCE vs. REVERSE VOLTAGE

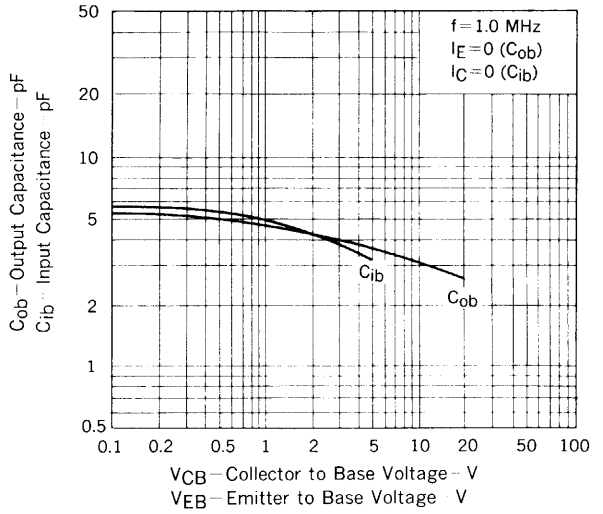

STORAGE TIME vs. COLLECTOR CURRENT

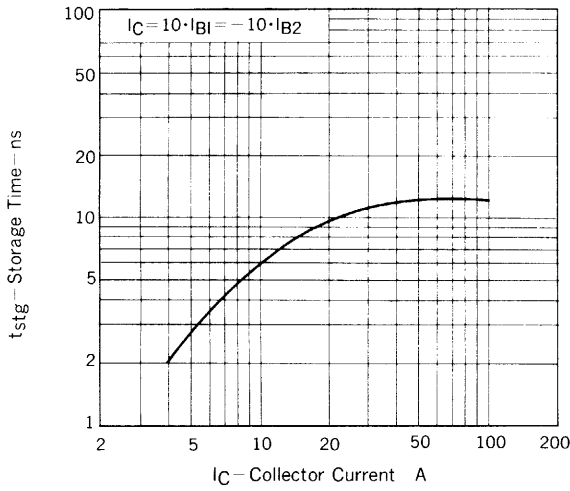

TURN ON TIME vs. BASE CURRENT

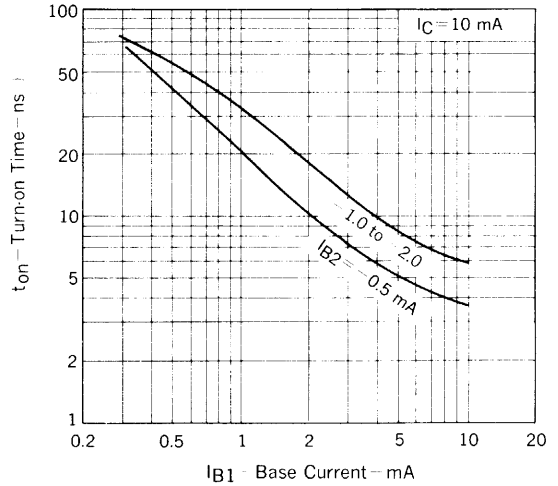

STORAGE TIME vs. BASE CURRENT

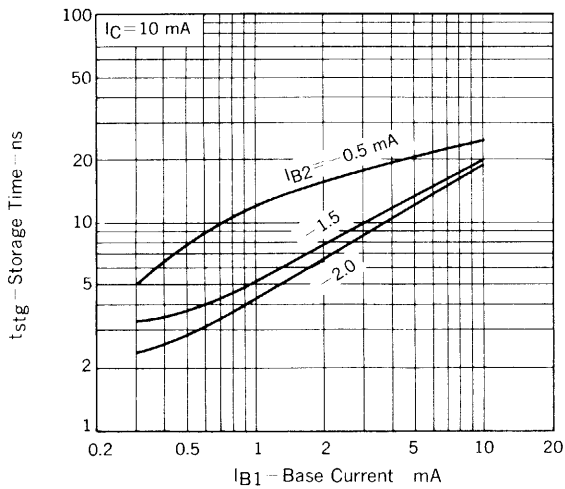

TURN OFF TIME vs. BASE CURRENT

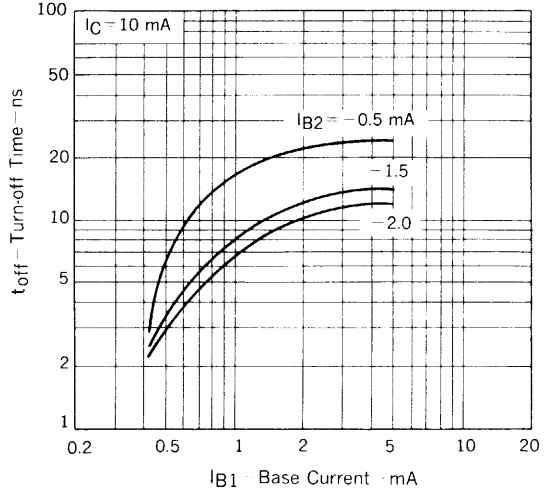

SWITCHING TIME TEST CIRCUIT

t_{on} , t_{off} TEST CIRCUIT

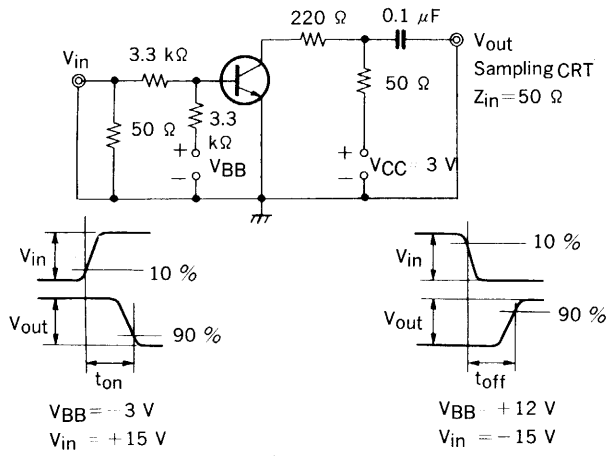

t_{stg} TEST CIRCUIT

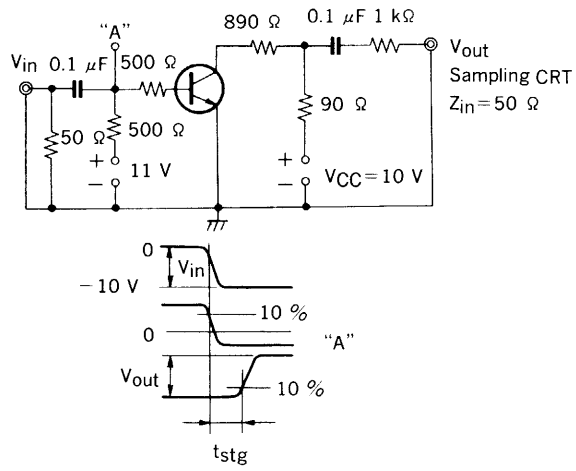

NEC Corporation

INTERNATIONAL ELECTRON DEVICES DIV.
 SUMITOMO MITA Building, 37-8,
 Shiba Gochome, Minato-ku, Tokyo 108, Japan
 Tel: Tokyo 456-3111
 Telex Address: NECTOK J22686
 Cable Address: NEC TOKYO



LittleDiode supplies new, hard to find or obsolete electronic components and semiconductors all over the world.

With over two million different components listed you are sure to find the part you need.

Feel free to visit us today at our online store:

LittleDiode.com

Looking forward to providing you with the best possible service.