

## Description

- Medium power amplifier

## Features

- Large collector current :  $I_{CMax} = -500mA$
- Suitable for low-Voltage operation because of its low saturation voltage
- Complementary pair with 2SC5342

## Ordering Information

Type NO.	Marking	Package Code
2SA1979	A1979	TO-92

## Outline Dimensions

unit : mm

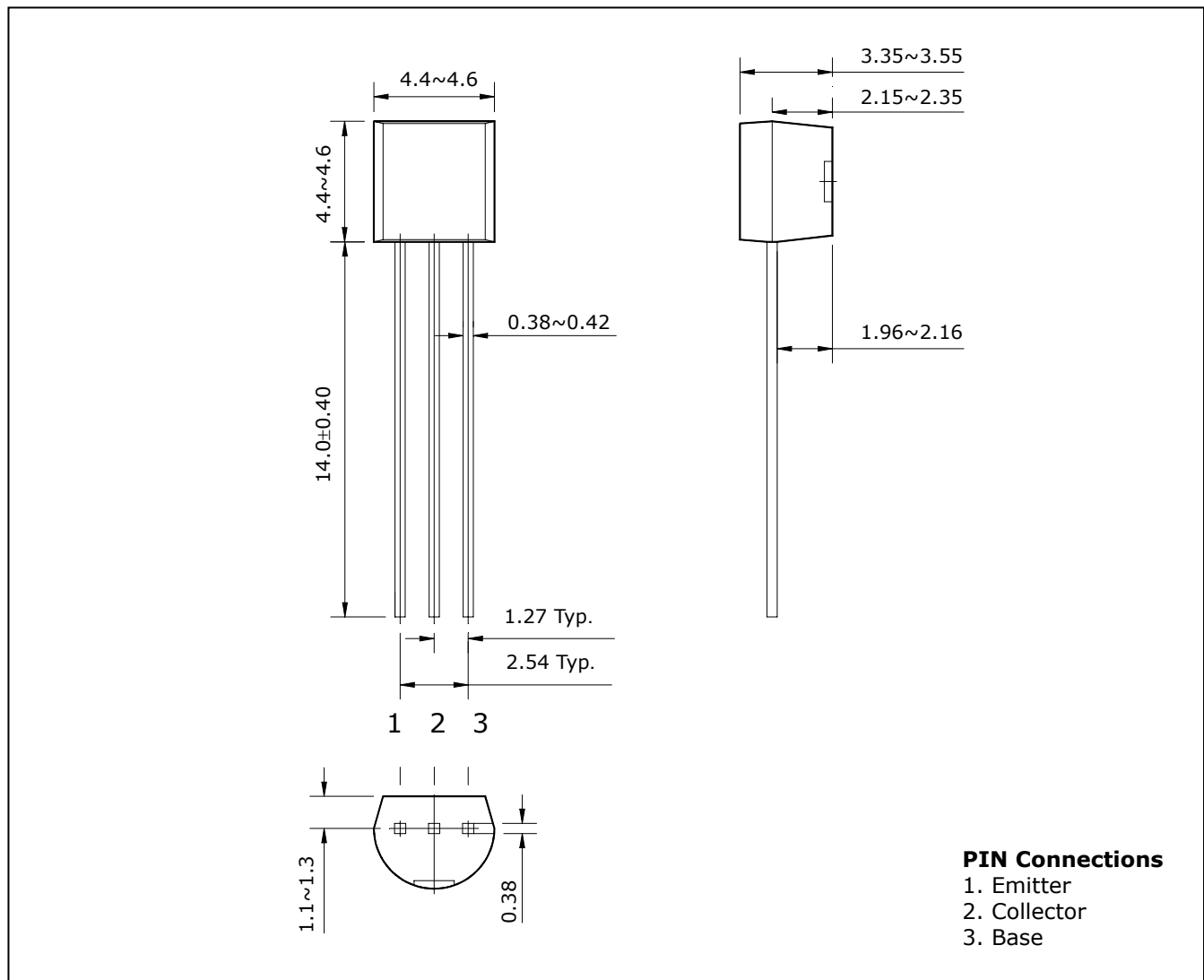

**Absolute maximum ratings**

(Ta=25°C)

Characteristic	Symbol	Ratings	Unit
Collector-Base voltage	$V_{CBO}$	-40	V
Collector-Emitter voltage	$V_{CEO}$	-32	V
Emitter-Base voltage	$V_{EBO}$	-5	V
Collector current	$I_C$	-500	mA
Collector dissipation	$P_C$	625	mW
Junction temperature	$T_j$	150	°C
Storage temperature	$T_{stg}$	-55~150	°C

**Electrical Characteristics**

(Ta=25°C)

Characteristic	Symbol	Test Condition	Min.	Typ.	Max.	Unit
Collector-Base breakdown voltage	$BV_{CBO}$	$I_C = -100\mu A, I_E = 0$	-40	-	-	V
Collector-Emitter breakdown voltage	$BV_{CEO}$	$I_C = -1mA, I_B = 0$	-32	-	-	V
Emitter-Base breakdown voltage	$BV_{EBO}$	$I_E = -10\mu A, I_C = 0$	-5	-	-	V
Collector cut-off current	$I_{CBO}$	$V_{CB} = -40V, I_E = 0$	-	-	-0.1	$\mu A$
Emitter cut-off current	$I_{EBO}$	$V_{EB} = -5V, I_C = 0$	-	-	-0.1	$\mu A$
DC current gain	$h_{FE}^*$	$V_{CE} = -1V, I_C = -100mA$	70	-	240	-
Collector-Emitter saturation voltage	$V_{CE(sat)}$	$I_C = -100mA, I_B = -10mA$	-	-	-0.25	V
Transistor frequency	$f_T$	$V_{CE} = -6V, I_C = -20mA$	-	200	-	MHz
Collector output capacitance	$C_{ob}$	$V_{CB} = -6V, I_E = 0, f = 1MHz$	-	7.5	-	pF

\* :  $h_{FE}$  rank / O : 70~140, Y : 120~240

Electrical Characteristic Curves

Fig. 1  $P_C - T_a$

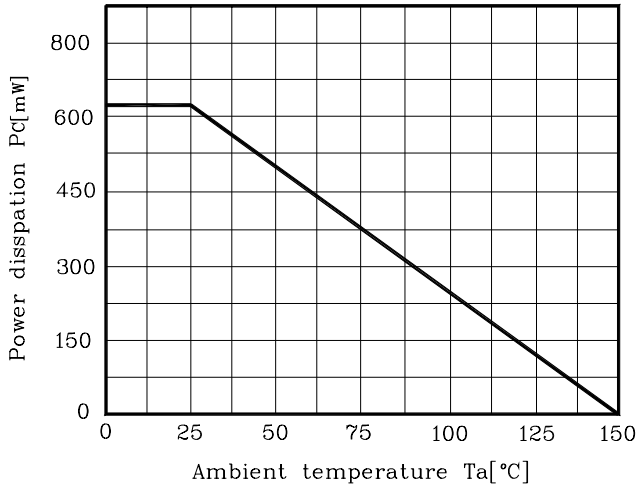

Fig. 2  $I_C - V_{BE}$

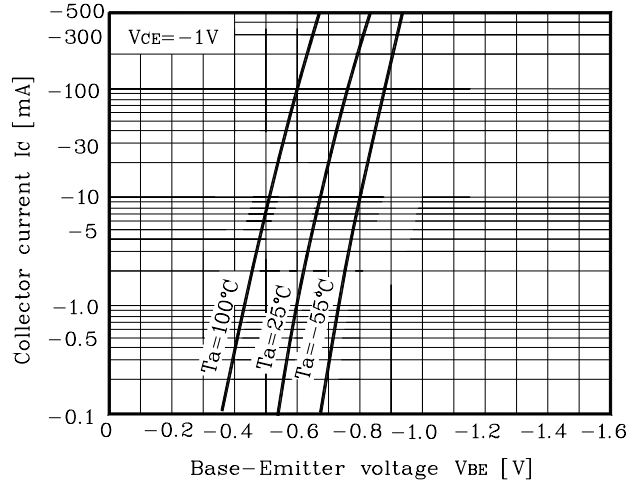

Fig. 3  $I_C - V_{CE}$

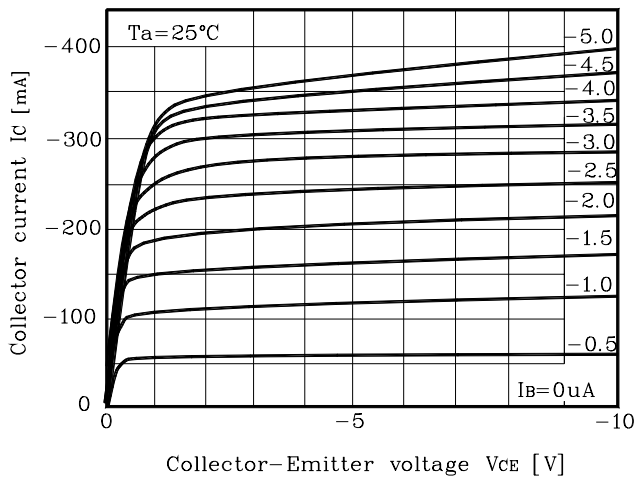

Fig. 4  $V_{CE(sat)} - I_C$

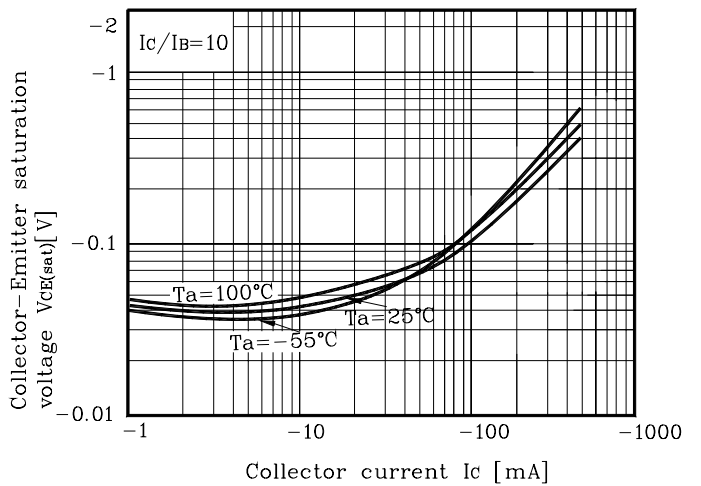

Fig. 5  $h_{FE} - I_C$

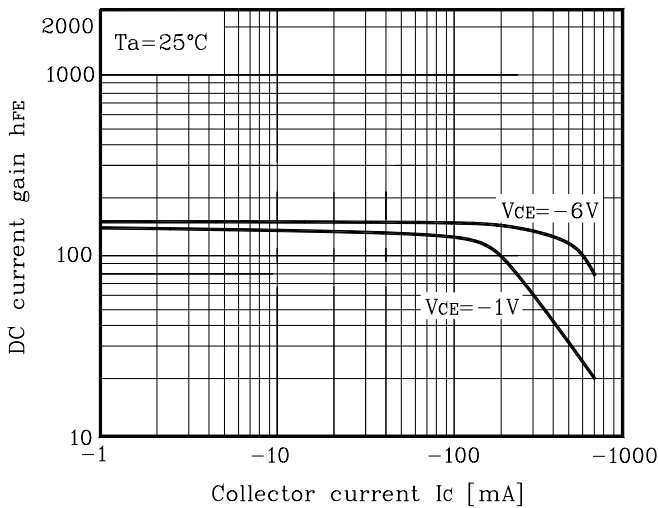
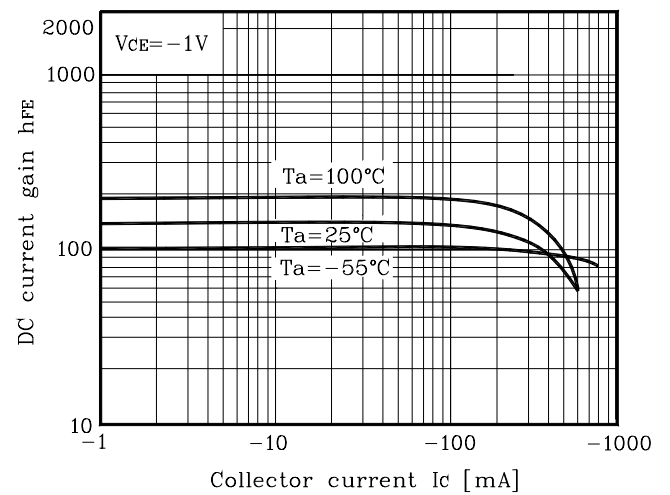

Fig. 6  $h_{FE} - I_C$



**These AUK products are intended for usage in general electronic equipments(Office and communication equipment, measuring equipment, domestic electrification, etc.).**

**Please make sure that you consult with us before you use these AUK products in equipments which require high quality and/or reliability, and in equipments which could have major impact to the welfare of human life(atomic energy control, airplane, spaceship, traffic signal, combustion central, all types of safety device, etc.).**

**AUK cannot accept liability to any damage which may occur in case these AUK products were used in the mentioned equipments without prior consultation with AUK.**



LittleDiode supplies new, hard to find or obsolete electronic components and semiconductors all over the world.

With over two million different components listed you are sure to find the part you need.

Feel free to visit us today at our online store:

**[LittleDiode.com](http://LittleDiode.com)**

Looking forward to providing you with the best possible service.