

**FAIRCHILD**

A Schlumberger Company

**2N6757/2N6758**  
**N-Channel Power MOSFETs,**  
**9 A, 150 V/200 V**

T-39-11

Power And Discrete Division

**Description**

These devices are n-channel, enhancement mode, power MOSFETs designed especially for high power, high speed applications, such as switching power supplies, UPS, AC and DC motor controls, relay and solenoid drivers and high energy pulse circuits.

TO-204AA

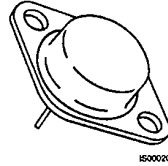

2N6757  
 2N6758

- V<sub>GS</sub> Rated at ±20 V
- Silicon Gate for Fast Switching Speeds
- I<sub>DSS</sub>, R<sub>DS(on)</sub>, Specified at Elevated Temperature
- Rugged
- Low Drive Requirements
- Ease of Paralleling

**Maximum Ratings**

Symbol	Characteristic	Rating 2N6758	Rating 2N6757	Unit
V <sub>DSS</sub>	Drain to Source Voltage	200	150	V
V <sub>DGR</sub>	Drain to Gate Voltage R <sub>GS</sub> = 1 MΩ	200	200	V
V <sub>GS</sub>	Gate to Source Voltage	±20	±20	V
T <sub>J</sub> , T <sub>stg</sub>	Operating Junction and Storage Temperatures	-55 to +150	-55 to +150	°C
T <sub>L</sub>	Maximum Lead Temperature for Soldering Purposes, 1/16" From Case for 10 s	300	300	°C

**Maximum On-State Characteristics**

R <sub>DS(on)</sub>	Static Drain-to-Source On Resistance	0.4	0.6	Ω
I <sub>D</sub>	Drain Current Continuous at T <sub>C</sub> = 25°C	9.0	8.0	A
I <sub>DM</sub>	Drain Current Continuous at T <sub>C</sub> = 100°C Pulsed	6.0 <sup>2</sup> 15 <sup>2</sup>	5.0 <sup>2</sup> 12 <sup>2</sup>	

**Maximum Thermal Characteristics**

R <sub>θJC</sub>	Thermal Resistance, Junction to Case	1.67	1.67	°C/W
P <sub>D</sub>	Total Power Dissipation at T <sub>C</sub> = 25°C	75	75	W
	Linear Derating Factor	0.6	0.6	W/°C

**Notes**

All values are JEDEC registered except as noted. For information concerning connection diagram and package outline, refer to Section 7.

2

**Electrical Characteristics** ( $T_C = 25^\circ\text{C}$  unless otherwise noted)

Symbol	Characteristic	Min	Max	Unit	Test Conditions
<b>Off Characteristics</b>					
$V_{(BR)DSS}$	Drain Source Breakdown Voltage 2N6758 2N6757			V	$V_{GS} = 0\text{ V}, I_D = 1\text{ mA}$
		200 <sup>2</sup>			
		150 <sup>2</sup>			
$I_{DSS}$	Zero Gate Voltage Drain Current		1	mA	$V_{DS} = \text{Rated } V_{DSS}, V_{GS} = 0\text{ V}$
			4		
$I_{GSS}$	Gate-Body Leakage Current		$\pm 100$	nA	$V_{GS} = \pm 20\text{ V}, V_{DS} = 0\text{ V}$
<b>On Characteristics</b>					
$V_{GS(th)}$	Gate Threshold Voltage	2.0	4.0	V	$I_D = 1\text{ mA}, V_{DS} = V_{GS}$
$R_{DS(on)}$	Static Drain-Source On-Resistance 2N6758 2N6757 2N6758 2N6757			$\Omega$	$V_{GS} = 10\text{ V}$ $I_D = 6\text{ A}$ $I_D = 5\text{ A}$ $I_D = 6\text{ A}, T_C = 125^\circ\text{C}$ $I_D = 5\text{ A}, T_C = 125^\circ\text{C}$
			0.4		
			0.6		
			0.75		
			1.13		
$V_{DS(on)}$	Drain-Source On-Voltage <sup>1</sup> 2N6758 2N6757		3.6	V	$V_{GS} = 10\text{ V}; I_D = 9\text{ A}$ $V_{GS} = 10\text{ V}; I_D = 8\text{ A}$
			4.8		
$g_{fs}$	Forward Transconductance <sup>1</sup>	3.0	9.0	S ( $\Omega$ )	$V_{DS} = 15\text{ V}, I_D = 6\text{ A}$
<b>Dynamic Characteristics</b>					
$C_{iss}$	Input Capacitance	350	800	pF	$V_{DS} = 25\text{ V}, V_{GS} = 0\text{ V}$ $f = 1.0\text{ MHz}$
$C_{oss}$	Output Capacitance	100	450	pF	
$C_{rss}$	Reverse Transfer Capacitance	40	150	pF	
<b>Switching Characteristics</b> ( $T_C = 25^\circ\text{C}$ , Figures 9, 10)					
$t_{d(on)}$	Turn-On Delay Time		30	ns	$V_{DD} = 90\text{ V}, I_D = 6\text{ A}$ $V_{GS} = 10\text{ V}, R_{GEN} = 15\ \Omega$ $R_{GS} = 15\ \Omega$
$t_r$	Rise Time		50	ns	
$t_{d(off)}$	Turn-Off Delay Time		50	ns	
$t_f$	Fall Time		40	ns	
$Q_g$	Total Gate Charge		30 <sup>2</sup>	nC	$V_{GS} = 10\text{ V}, I_D = 12\text{ A}$ $V_{DD} = 120\text{ V}$

**Electrical Characteristics (Cont.)** ( $T_C = 25^\circ\text{C}$  unless otherwise noted)

Symbol	Characteristic	Min	Typ	Max	Unit	Test Conditions
<b>Source-Drain Diode Characteristics</b>						
$I_S$	Continuous Source Current 2N6758 2N6757			9.0	A	
				8.0		
$I_{SM}$	Pulsed Source Current 2N6758 2N6757			15 <sup>2</sup>	A	
				12 <sup>2</sup>		
$V_{SD}$	Diode Forward Voltage 2N6758  2N6757	0.80		1.60	V	$V_{GS} = 0\text{ V}$ $I_S = 9\text{ A}$  $I_S = 8\text{ A}$
		0.75		1.50		
$t_{rr}$	Reverse Recovery Time		650 <sup>2</sup>		ns	$V_{GS} = 0\text{ V}$ , $T_J = 150^\circ\text{C}$ $I_F = I_{SM}$ , $di_F/dt = 100\text{ A}/\mu\text{S}$
$Q_{RR}$	Reverse Recovery Charge		10 <sup>2</sup>		$\mu\text{C}$	$V_{GS} = 0\text{ V}$ , $T_J = 150^\circ\text{C}$ $I_F = I_{SM}$ , $di_F/dt = 100\text{ A}$

**Notes**

1. Pulse test: Pulse width  $\leq 300\ \mu\text{s}$ , Duty cycle  $\leq 2\%$
2. Non-JEDEC registered value.

**Typical Performance Curves**

**Figure 1 Output Characteristics**

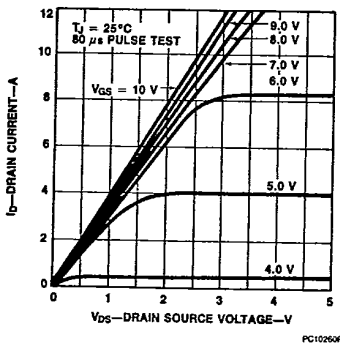

**Figure 2 Static Drain to Source Resistance vs Drain Current**

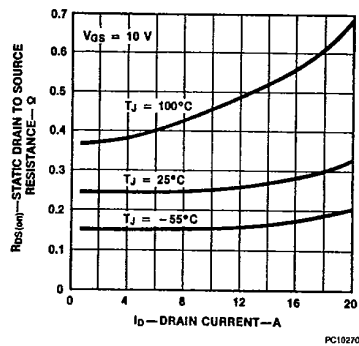

Typical Performance Curves (Cont.)

Figure 3 Transfer Characteristics

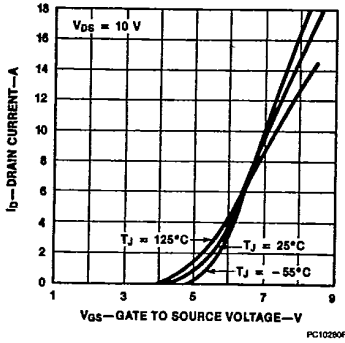

Figure 4 Temperature Variation of Gate to Source Threshold Voltage

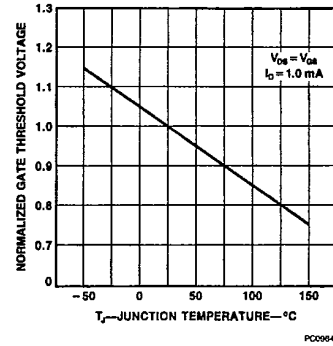

Figure 5 Capacitance vs Drain to Source Voltage

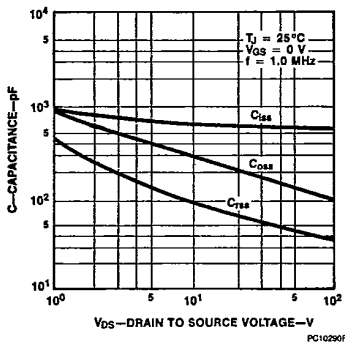

Figure 6 Gate to Source Voltage vs Total Gate Charge

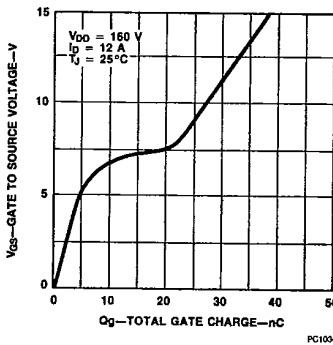

Figure 7 Forward Biased Safe Operating Area

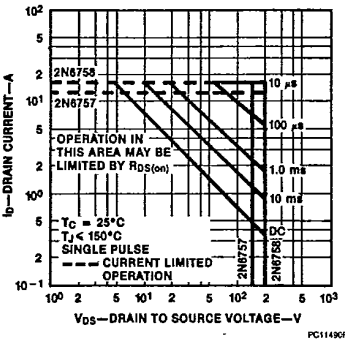
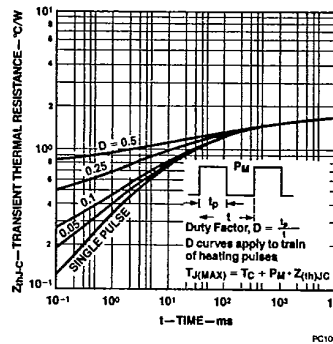

Figure 8 Transient Thermal Resistance vs Time



2N6757/2N6758

T-39-11

Typical Electrical Characteristics

Figure 9 Switching Test Circuit

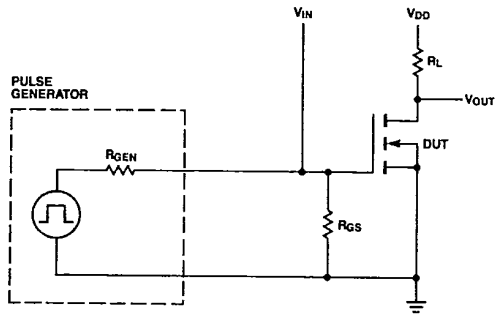

CR04450F

Figure 10 Switching Waveforms

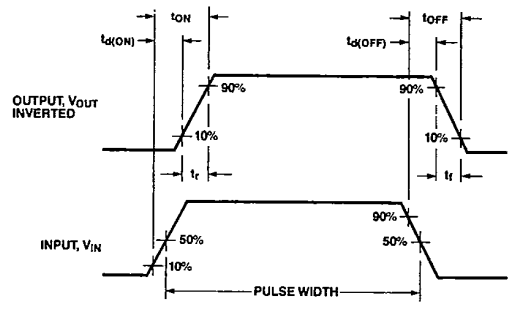

WT00000F

This datasheet has been downloaded from:

[www.DatasheetCatalog.com](http://www.DatasheetCatalog.com)

Datasheets for electronic components.



LittleDiode supplies new, hard to find or obsolete electronic components and semiconductors all over the world.

With over two million different components listed you are sure to find the part you need.

Feel free to visit us today at our online store:

[LittleDiode.com](http://LittleDiode.com)

Looking forward to providing you with the best possible service.