

# 2N6394 Series

Preferred Device

## Silicon Controlled Rectifiers

### Reverse Blocking Thyristors

Designed primarily for half-wave ac control applications, such as motor controls, heating controls and power supplies.

- Glass Passivated Junctions with Center Gate Geometry for Greater Parameter Uniformity and Stability
- Small, Rugged, Thermowatt Construction for Low Thermal Resistance, High Heat Dissipation and Durability
- Blocking Voltage to 800 Volts
- Device Marking: Logo, Device Type, e.g., 2N6394, Date Code

\***MAXIMUM RATINGS** ( $T_J = 25^\circ\text{C}$  unless otherwise noted)

Rating	Symbol	Value	Unit
Peak Repetitive Off-State Voltage (Note 1.) ( $T_J = -40$ to $125^\circ\text{C}$ , Sine Wave, 50 to 60 Hz, Gate Open)	$V_{DRM}$ , $V_{RRM}$	50 100 400 800	Volts
On-State RMS Current ( $180^\circ$ Conduction Angles; $T_C = 90^\circ\text{C}$ )	$I_{T(RMS)}$	12	A
Peak Non-Repetitive Surge Current (1/2 Cycle, Sine Wave, 60 Hz, $T_J = 90^\circ\text{C}$ )	$I_{TSM}$	100	A
Circuit Fusing ( $t = 8.3$ ms)	$I^2t$	40	$\text{A}^2\text{s}$
Forward Peak Gate Power (Pulse Width $\leq 1.0$ $\mu\text{s}$ , $T_C = 90^\circ\text{C}$ )	$P_{GM}$	20	Watts
Forward Average Gate Power ( $t = 8.3$ ms, $T_C = 90^\circ\text{C}$ )	$P_{G(AV)}$	0.5	Watts
Forward Peak Gate Current (Pulse Width $\leq 1.0$ $\mu\text{s}$ , $T_C = 90^\circ\text{C}$ )	$I_{GM}$	2.0	A
Operating Junction Temperature Range	$T_J$	-40 to +125	$^\circ\text{C}$
Storage Temperature Range	$T_{stg}$	-40 to +150	$^\circ\text{C}$

\*Indicates JEDEC Registered Data

1.  $V_{DRM}$  and  $V_{RRM}$  for all types can be applied on a continuous basis. Ratings apply for zero or negative gate voltage; however, positive gate voltage shall not be applied concurrent with negative potential on the anode. Blocking voltages shall not be tested with a constant current source such that the voltage ratings of the devices are exceeded.



ON Semiconductor™

<http://onsemi.com>

**SCRs**  
**12 AMPERES RMS**  
**50 thru 800 VOLTS**

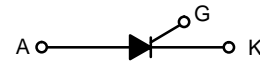

#### MARKING DIAGRAM

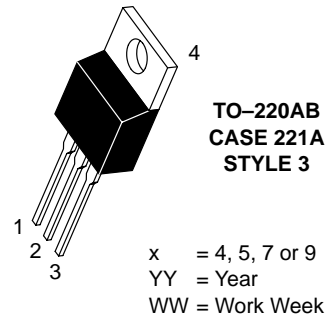

#### PIN ASSIGNMENT

Pin	Assignment
1	Cathode
2	Anode
3	Gate
4	Anode

#### ORDERING INFORMATION

Device	Package	Shipping
2N6394	TO220AB	500/Box
2N6395	TO220AB	500/Box
2N6397	TO220AB	500/Box
2N6399	TO220AB	500/Box

Preferred devices are recommended choices for future use and best overall value.

## 2N6394 Series

### THERMAL CHARACTERISTICS

Characteristic	Symbol	Max	Unit
Thermal Resistance, Junction to Case	$R_{\theta JC}$	2.0	$^{\circ}C/W$
Maximum Lead Temperature for Soldering Purposes 1/8" from Case for 10 Seconds	$T_L$	260	$^{\circ}C$

### ELECTRICAL CHARACTERISTICS ( $T_C = 25^{\circ}C$ unless otherwise noted.)

Characteristic	Symbol	Min	Typ	Max	Unit
----------------	--------	-----	-----	-----	------

### OFF CHARACTERISTICS

*Peak Repetitive Forward or Reverse Blocking Current ( $V_{AK} = \text{Rated } V_{DRM} \text{ or } V_{RRM}$ , Gate Open)	$I_{DRM}, I_{RRM}$	–	–	10	$\mu A$
$T_J = 25^{\circ}C$		–	–	2.0	mA
$T_J = 125^{\circ}C$		–	–		

### ON CHARACTERISTICS

*Peak Forward On-State Voltage (Note 2.) ( $I_{TM} = 24 \text{ A Peak}$ )	$V_{TM}$	–	1.7	2.2	Volts
*Gate Trigger Current (Continuous dc) ( $V_D = 12 \text{ Vdc}$ , $R_L = 100 \text{ Ohms}$ )	$I_{GT}$	–	5.0	30	mA
*Gate Trigger Voltage (Continuous dc) ( $V_D = 12 \text{ Vdc}$ , $R_L = 100 \text{ Ohms}$ )	$V_{GT}$	–	0.7	1.5	Volts
Gate Non-Trigger Voltage ( $V_D = 12 \text{ Vdc}$ , $R_L = 100 \text{ Ohms}$ , $T_J = 125^{\circ}C$ )	$V_{GD}$	0.2	–	–	Volts
*Holding Current ( $V_D = 12 \text{ Vdc}$ , Initiating Current = 200 mA, Gate Open)	$I_H$	–	6.0	50	mA
Turn-On Time ( $I_{TM} = 12 \text{ A}$ , $I_{GT} = 40 \text{ mAdc}$ , $V_D = \text{Rated } V_{DRM}$ )	$t_{gt}$	–	1.0	2.0	$\mu s$
Turn-Off Time ( $V_D = \text{Rated } V_{DRM}$ ) ( $I_{TM} = 12 \text{ A}$ , $I_R = 12 \text{ A}$ ) ( $I_{TM} = 12 \text{ A}$ , $I_R = 12 \text{ A}$ , $T_J = 125^{\circ}C$ )	$t_q$	–	15	–	$\mu s$
		–	35	–	

### DYNAMIC CHARACTERISTICS

Critical Rate-of-Rise of Off-State Voltage Exponential ( $V_D = \text{Rated } V_{DRM}$ , $T_J = 125^{\circ}C$ )	$dv/dt$	–	50	–	$V/\mu s$
--	---------	---	----	---	-----------

\*Indicates JEDEC Registered Data

2. Pulse Test: Pulse Width  $\leq 300 \mu s$ , Duty Cycle  $\leq 2\%$ .

# 2N6394 Series

## Voltage Current Characteristic of SCR

Symbol	Parameter
$V_{DRM}$	Peak Repetitive Off State Forward Voltage
$I_{DRM}$	Peak Forward Blocking Current
$V_{RRM}$	Peak Repetitive Off State Reverse Voltage
$I_{RRM}$	Peak Reverse Blocking Current
$V_{TM}$	Peak On State Voltage
$I_H$	Holding Current

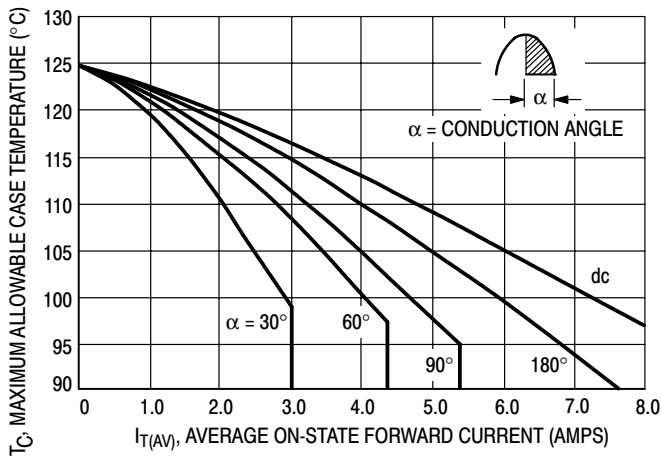
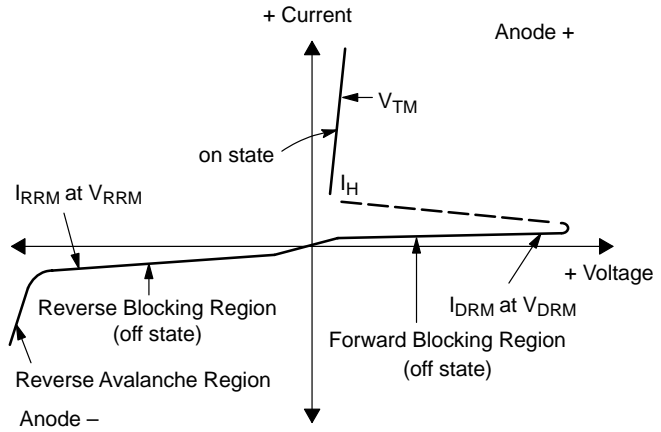

Figure 1. Current Derating

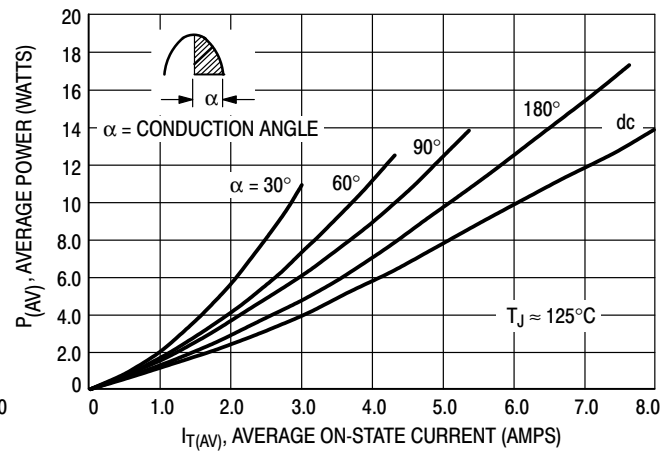

Figure 2. Maximum On-State Power Dissipation

# 2N6394 Series

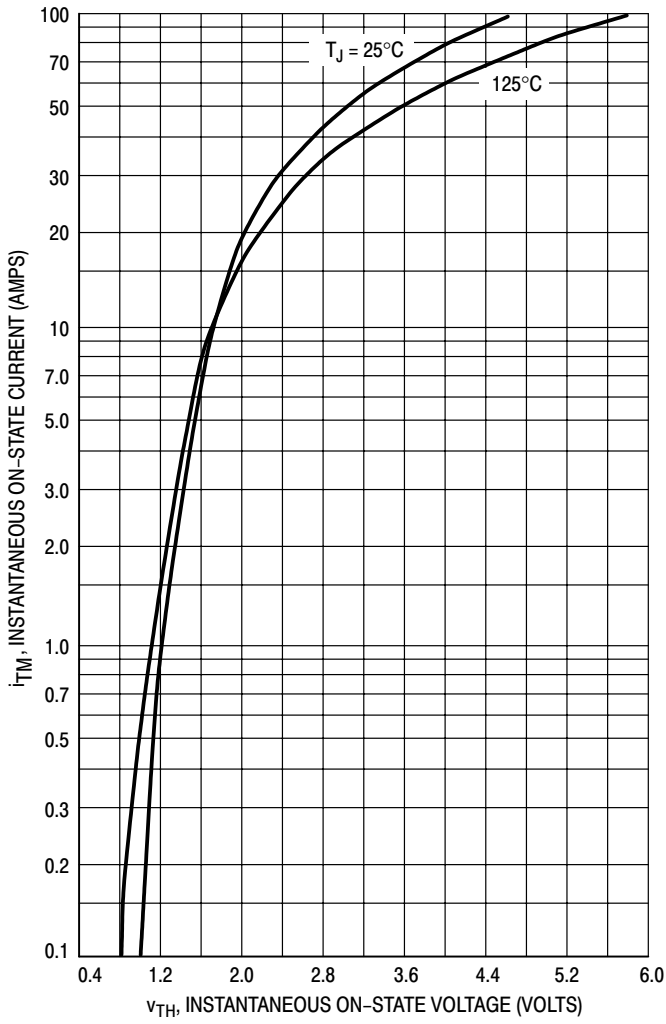

Figure 3. On-State Characteristics

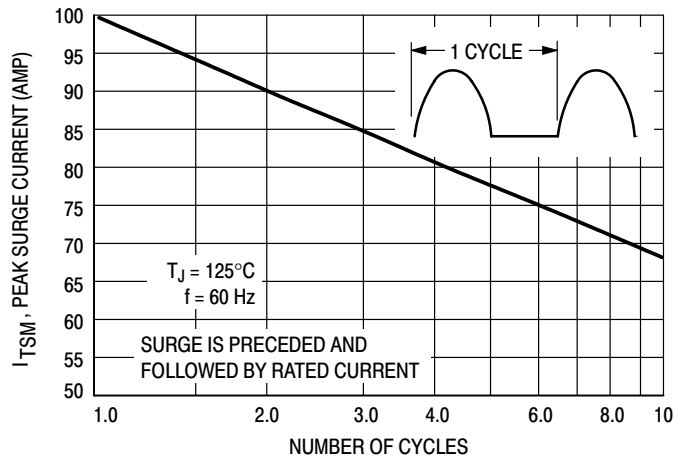

Figure 4. Maximum Non-Repetitive Surge Current

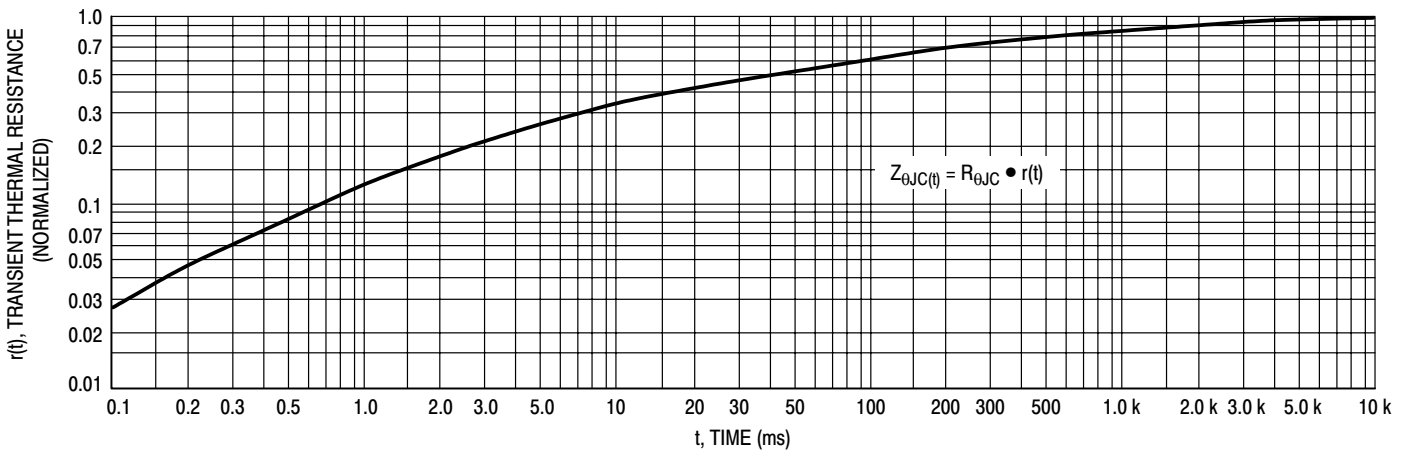

Figure 5. Thermal Response

# 2N6394 Series

## TYPICAL CHARACTERISTICS

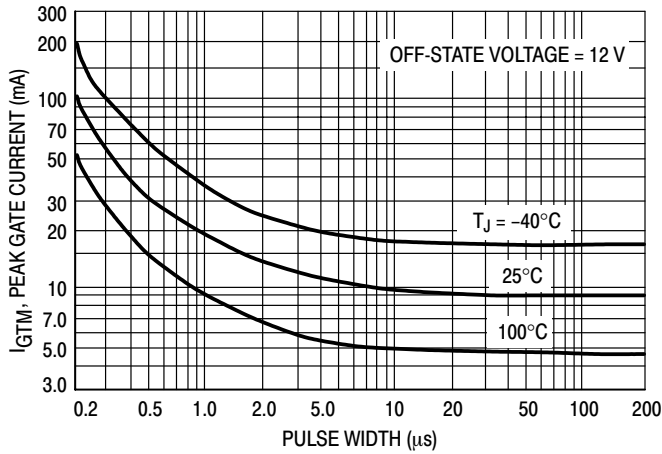

Figure 6. Typical Gate Trigger Current versus Pulse Width

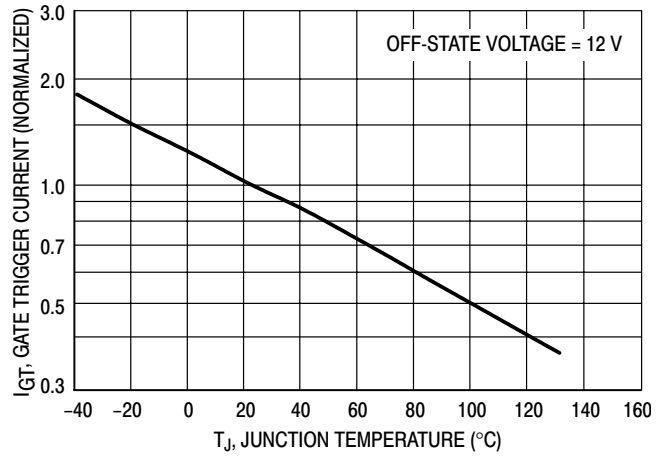

Figure 7. Typical Gate Trigger Current versus Temperature

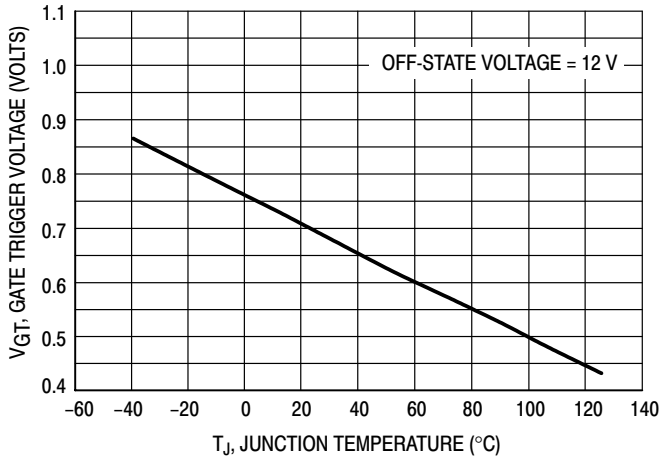

Figure 8. Typical Gate Trigger Voltage versus Temperature

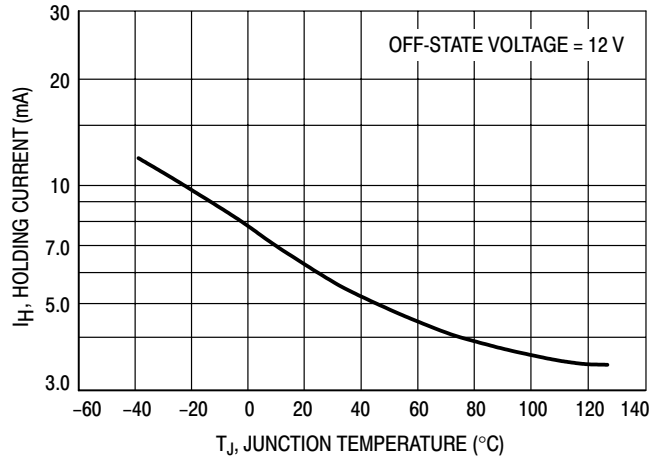
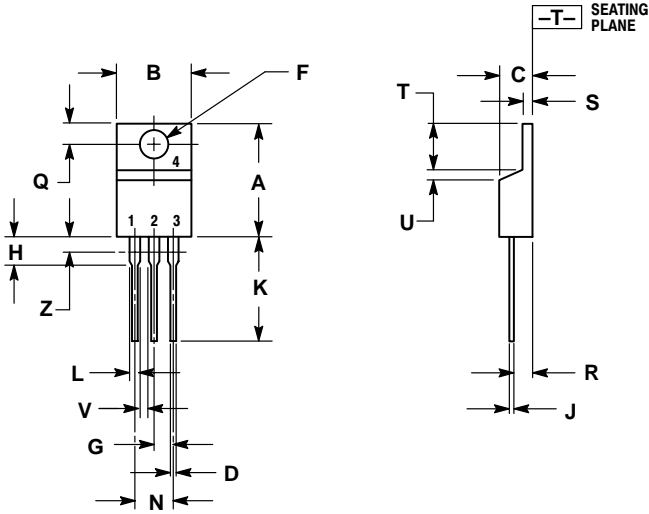

Figure 9. Typical Holding Current versus Temperature

# 2N6394 Series

## PACKAGE DIMENSIONS

TO-220AB  
CASE 221A-07  
ISSUE AA



- NOTES:
1. DIMENSIONING AND TOLERANCING PER ANSI Y14.5M, 1982.
  2. CONTROLLING DIMENSION: INCH.
  3. DIMENSION Z DEFINES A ZONE WHERE ALL BODY AND LEAD IRREGULARITIES ARE ALLOWED.

DIM	INCHES		MILLIMETERS	
	MIN	MAX	MIN	MAX
A	0.570	0.620	14.48	15.75
B	0.380	0.405	9.66	10.28
C	0.160	0.190	4.07	4.82
D	0.025	0.035	0.64	0.88
F	0.142	0.147	3.61	3.73
G	0.095	0.105	2.42	2.66
H	0.110	0.155	2.80	3.93
J	0.014	0.022	0.36	0.55
K	0.500	0.562	12.70	14.27
L	0.045	0.060	1.15	1.52
N	0.190	0.210	4.83	5.33
Q	0.100	0.120	2.54	3.04
R	0.080	0.110	2.04	2.79
S	0.045	0.055	1.15	1.39
T	0.235	0.255	5.97	6.47
U	0.000	0.050	0.00	1.27
V	0.045	---	1.15	---
Z	---	0.080	---	2.04

- STYLE 3:  
PIN 1. CATHODE  
2. ANODE  
3. GATE  
4. ANODE

**Notes**

## 2N6394 Series

**ON Semiconductor** and  are trademarks of Semiconductor Components Industries, LLC (SCILLC). SCILLC reserves the right to make changes without further notice to any products herein. SCILLC makes no warranty, representation or guarantee regarding the suitability of its products for any particular purpose, nor does SCILLC assume any liability arising out of the application or use of any product or circuit, and specifically disclaims any and all liability, including without limitation special, consequential or incidental damages. "Typical" parameters which may be provided in SCILLC data sheets and/or specifications can and do vary in different applications and actual performance may vary over time. All operating parameters, including "Typicals" must be validated for each customer application by customer's technical experts. SCILLC does not convey any license under its patent rights nor the rights of others. SCILLC products are not designed, intended, or authorized for use as components in systems intended for surgical implant into the body, or other applications intended to support or sustain life, or for any other application in which the failure of the SCILLC product could create a situation where personal injury or death may occur. Should Buyer purchase or use SCILLC products for any such unintended or unauthorized application, Buyer shall indemnify and hold SCILLC and its officers, employees, subsidiaries, affiliates, and distributors harmless against all claims, costs, damages, and expenses, and reasonable attorney fees arising out of, directly or indirectly, any claim of personal injury or death associated with such unintended or unauthorized use, even if such claim alleges that SCILLC was negligent regarding the design or manufacture of the part. SCILLC is an Equal Opportunity/Affirmative Action Employer.

### PUBLICATION ORDERING INFORMATION

#### **NORTH AMERICA Literature Fulfillment:**

Literature Distribution Center for ON Semiconductor  
P.O. Box 5163, Denver, Colorado 80217 USA  
**Phone:** 303-675-2175 or 800-344-3860 Toll Free USA/Canada  
**Fax:** 303-675-2176 or 800-344-3867 Toll Free USA/Canada  
**Email:** ONlit@hibbertco.com  
Fax Response Line: 303-675-2167 or 800-344-3810 Toll Free USA/Canada

**N. American Technical Support:** 800-282-9855 Toll Free USA/Canada

**EUROPE:** LDC for ON Semiconductor – European Support

**German Phone:** (+1) 303-308-7140 (Mon-Fri 2:30pm to 7:00pm CET)  
**Email:** ONlit-german@hibbertco.com  
**French Phone:** (+1) 303-308-7141 (Mon-Fri 2:00pm to 7:00pm CET)  
**Email:** ONlit-french@hibbertco.com  
**English Phone:** (+1) 303-308-7142 (Mon-Fri 12:00pm to 5:00pm GMT)  
**Email:** ONlit@hibbertco.com

**EUROPEAN TOLL-FREE ACCESS\*: 00-800-4422-3781**

\*Available from Germany, France, Italy, UK, Ireland

#### **CENTRAL/SOUTH AMERICA:**

**Spanish Phone:** 303-308-7143 (Mon-Fri 8:00am to 5:00pm MST)  
**Email:** ONlit-spanish@hibbertco.com  
**Toll-Free from Mexico:** Dial 01-800-288-2872 for Access –  
then Dial 866-297-9322

**ASIA/PACIFIC:** LDC for ON Semiconductor – Asia Support

**Phone:** 1-303-675-2121 (Tue-Fri 9:00am to 1:00pm, Hong Kong Time)  
**Toll Free from Hong Kong & Singapore:**  
**001-800-4422-3781**

**Email:** ONlit-asia@hibbertco.com

**JAPAN:** ON Semiconductor, Japan Customer Focus Center

4-32-1 Nishi-Gotanda, Shinagawa-ku, Tokyo, Japan 141-0031  
**Phone:** 81-3-5740-2700  
**Email:** r14525@onsemi.com

**ON Semiconductor Website:** <http://onsemi.com>

For additional information, please contact your local Sales Representative.



LittleDiode supplies new, hard to find or obsolete electronic components and semiconductors all over the world.

With over two million different components listed you are sure to find the part you need.

Feel free to visit us today at our online store:

[LittleDiode.com](http://LittleDiode.com)

Looking forward to providing you with the best possible service.