

# 2N5638, 2N5639

2N5638 is a Preferred Device

## JFET Chopper Transistors

### N-Channel – Depletion

N-Channel Junction Field Effect Transistors, depletion mode (Type A) designed for chopper and high-speed switching applications.

- Low Drain-Source “ON” Resistance:  
 $R_{DS(on)} = 30\Omega$  for 2N5638  
 $R_{DS(on)} = 60\Omega$  for 2N5639
- Low Reverse Transfer Capacitance  
 $C_{RSS} = 4.0 \text{ pF (Max) @ } f = 1.0 \text{ MHz}$
- Fast Switching Characteristics  
 $t_r = 5.0 \text{ ns (Max) (2N5638)}$



**ON Semiconductor™**

<http://onsemi.com>

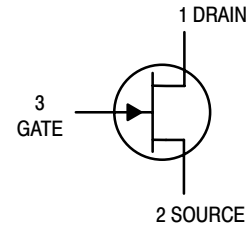

#### MAXIMUM RATINGS

Rating	Symbol	Value	Unit
Drain-Source Voltage	$V_{DS}$	30	Vdc
Drain-Gate Voltage	$V_{DG}$	30	Vdc
Reverse Gate-Source Voltage	$V_{GSR}$	30	Vdc
Forward Gate Current	$I_{GF}$	10	mAdc
Total Device Dissipation @ $T_A = 25^\circ\text{C}$ Derate above $25^\circ\text{C}$	$P_D$	310 2.82	mW mW/ $^\circ\text{C}$
Storage Temperature Range	$T_{stg}$	-65 to +150	$^\circ\text{C}$
Operating Junction Temp Range	$T_J$	-65 to +135	$^\circ\text{C}$

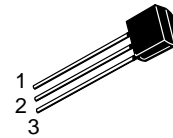

TO-92  
CASE 29  
STYLE 5

#### MARKING DIAGRAMS

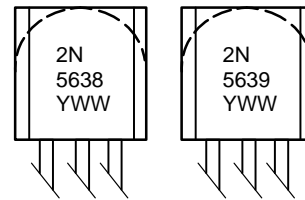

Y = Year  
WW = Work Week

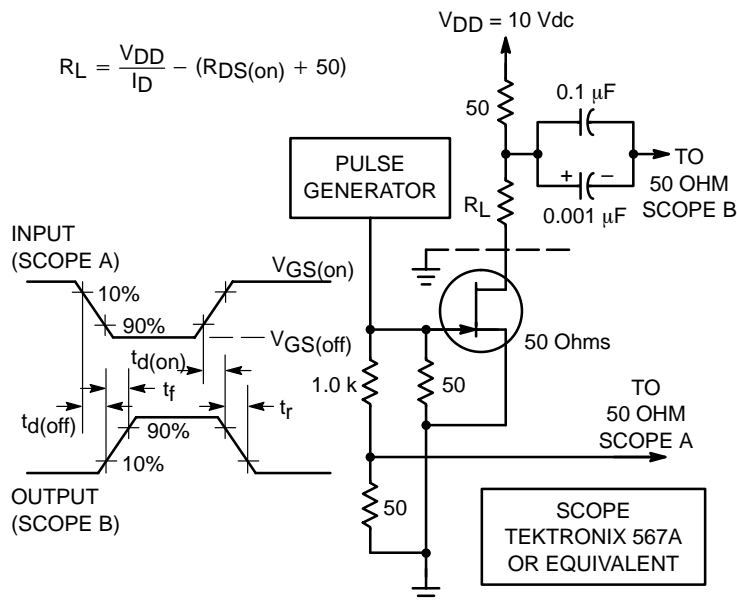

Figure 1. Switching Times Test Circuit

#### ORDERING INFORMATION

Device	Package	Shipping
2N5638RLRA	TO-92	2000/Tape & Reel
2N5639	TO-92	5000/Box
2N5369RLRA	TO-92	2000/Tape & Reel

Preferred devices are recommended choices for future use and best overall value.

## 2N5638, 2N5639

### ELECTRICAL CHARACTERISTICS (T<sub>A</sub> = 25°C unless otherwise noted)

Characteristic	Symbol	Min	Max	Unit
----------------	--------	-----	-----	------

#### OFF CHARACTERISTICS

Gate–Source Breakdown Voltage (I <sub>G</sub> = –1.0 μAdc, V <sub>DS</sub> = 0)	V <sub>(BR)GSS</sub>	35	–	Vdc
Gate Reverse Current (V <sub>GS</sub> = –15 Vdc, V <sub>DS</sub> = 0) (V <sub>GS</sub> = –15 Vdc, V <sub>DS</sub> = 0, T <sub>A</sub> = 100°C)	I <sub>GSS</sub>	–	1.0 1.0	nAdc μAdc
Drain–Cutoff Current (V <sub>DS</sub> = 15 Vdc, V <sub>GS</sub> = –12 Vdc) (V <sub>DS</sub> = 15 Vdc, V <sub>GS</sub> = –12 Vdc, T <sub>A</sub> = 100°C) (V <sub>DS</sub> = 15 Vdc, V <sub>GS</sub> = –8.0 Vdc) (V <sub>DS</sub> = 15 Vdc, V <sub>GS</sub> = –8.0 Vdc, T <sub>A</sub> = 100°C)	I <sub>D(off)</sub>	–	1.0 1.0 1.0 1.0	μAdc

#### ON CHARACTERISTICS

Zero–Gate–Voltage Drain Current (Note 1.) (V <sub>DS</sub> = 20 Vdc, V <sub>GS</sub> = 0)	2N5638 2N5639	I <sub>DSS</sub>	50 25	– –	mAdc
Drain–Source “ON” Voltage (I <sub>D</sub> = 12 mAdc, V <sub>GS</sub> = 0) (I <sub>D</sub> = 6.0 mAdc, V <sub>GS</sub> = 0)	2N5638 2N5639	V <sub>DS(on)</sub>	– –	0.5 0.5	Vdc
Static Drain–Source “ON” Resistance (I <sub>D</sub> = 1.0 mAdc, V <sub>GS</sub> = 0)	2N5638 2N5639	R <sub>DS(on)</sub>	– –	30 60	Ω

#### SMALL–SIGNAL CHARACTERISTICS

Static Drain–Source “ON” Resistance (V <sub>GS</sub> = 0, I <sub>D</sub> = 0, f = 1.0 kHz)	2N5638 2N5639	R <sub>DS(on)</sub>	– –	30 60	Ω
Input Capacitance (V <sub>DS</sub> = 0, V <sub>GS</sub> = –12 Vdc, f = 1.0 MHz)		C <sub>iss</sub>	–	10	pF
Reverse Transfer Capacitance (V <sub>DS</sub> = 0, V <sub>GS</sub> = –12 Vdc, f = 1.0 MHz)		C <sub>rss</sub>	–	4.0	pF

#### SWITCHING CHARACTERISTICS (V<sub>DD</sub> = 10 Vdc, V<sub>GS(on)</sub> = 0, V<sub>GS(off)</sub> = –10 Vdc, R<sub>G'</sub> = 50 Ω. See Figure 1 on page 1)

Turn–On Delay Time I <sub>D(on)</sub> = 12 mAdc, 2N5638 I <sub>D(on)</sub> = 6.0 mAdc, 2N5639	I <sub>D(on)</sub> = 12 mAdc, 2N5638 I <sub>D(on)</sub> = 6.0 mAdc, 2N5639	t <sub>d(on)</sub>	– –	4.0 6.0	ns
Rise Time I <sub>D(on)</sub> = 12 mAdc, 2N5638 I <sub>D(on)</sub> = 6.0 mAdc, 2N5639	I <sub>D(on)</sub> = 12 mAdc, 2N5638 I <sub>D(on)</sub> = 6.0 mAdc, 2N5639	t <sub>r</sub>	– –	5.0 8.0	ns
Turn–Off Delay Time I <sub>D(on)</sub> = 12 mAdc, 2N5638 I <sub>D(on)</sub> = 6.0 mAdc, 2N5639	I <sub>D(on)</sub> = 12 mAdc, 2N5638 I <sub>D(on)</sub> = 6.0 mAdc, 2N5639	t <sub>d(off)</sub>	– –	5.0 10	ns
Fall Time I <sub>D(on)</sub> = 12 mAdc, 2N5638 I <sub>D(on)</sub> = 6.0 mAdc, 2N5639	I <sub>D(on)</sub> = 12 mAdc, 2N5638 I <sub>D(on)</sub> = 6.0 mAdc, 2N5639	t <sub>f</sub>	– –	10 20	ns

1. Pulse Width ≤ 300 μs, Duty Cycle ≤ 3.0%.

# 2N5638, 2N5639

## PACKAGE DIMENSIONS

TO-92 (TO-226)  
CASE 29-11  
ISSUE AL

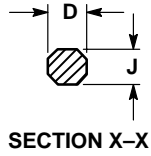
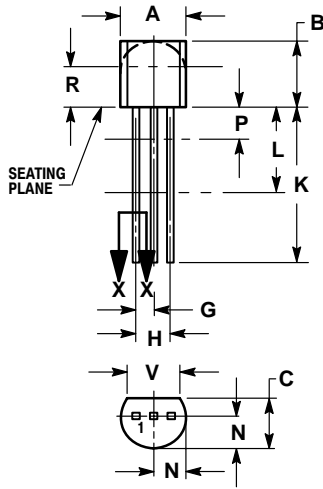

NOTES:

1. DIMENSIONING AND TOLERANCING PER ANSI Y14.5M, 1982.
2. CONTROLLING DIMENSION: INCH.
3. CONTOUR OF PACKAGE BEYOND DIMENSION R IS UNCONTROLLED.
4. LEAD DIMENSION IS UNCONTROLLED IN P AND BEYOND DIMENSION K MINIMUM.

DIM	INCHES		MILLIMETERS	
	MIN	MAX	MIN	MAX
A	0.175	0.205	4.45	5.20
B	0.170	0.210	4.32	5.33
C	0.125	0.165	3.18	4.19
D	0.016	0.021	0.407	0.533
G	0.045	0.055	1.15	1.39
H	0.095	0.105	2.42	2.66
J	0.015	0.020	0.39	0.50
K	0.500	---	12.70	---
L	0.250	---	6.35	---
N	0.080	0.105	2.04	2.66
P	---	0.100	---	2.54
R	0.115	---	2.93	---
V	0.135	---	3.43	---

**ON Semiconductor** and  are trademarks of Semiconductor Components Industries, LLC (SCILLC). SCILLC reserves the right to make changes without further notice to any products herein. SCILLC makes no warranty, representation or guarantee regarding the suitability of its products for any particular purpose, nor does SCILLC assume any liability arising out of the application or use of any product or circuit, and specifically disclaims any and all liability, including without limitation special, consequential or incidental damages. "Typical" parameters which may be provided in SCILLC data sheets and/or specifications can and do vary in different applications and actual performance may vary over time. All operating parameters, including "Typicals" must be validated for each customer application by customer's technical experts. SCILLC does not convey any license under its patent rights nor the rights of others. SCILLC products are not designed, intended, or authorized for use as components in systems intended for surgical implant into the body, or other applications intended to support or sustain life, or for any other application in which the failure of the SCILLC product could create a situation where personal injury or death may occur. Should Buyer purchase or use SCILLC products for any such unintended or unauthorized application, Buyer shall indemnify and hold SCILLC and its officers, employees, subsidiaries, affiliates, and distributors harmless against all claims, costs, damages, and expenses, and reasonable attorney fees arising out of, directly or indirectly, any claim of personal injury or death associated with such unintended or unauthorized use, even if such claim alleges that SCILLC was negligent regarding the design or manufacture of the part. SCILLC is an Equal Opportunity/Affirmative Action Employer.

## PUBLICATION ORDERING INFORMATION

### Literature Fulfillment:

Literature Distribution Center for ON Semiconductor  
P.O. Box 5163, Denver, Colorado 80217 USA  
**Phone:** 303-675-2175 or 800-344-3860 Toll Free USA/Canada  
**Fax:** 303-675-2176 or 800-344-3867 Toll Free USA/Canada  
**Email:** ONlit@hibbertco.com

**N. American Technical Support:** 800-282-9855 Toll Free USA/Canada

**JAPAN:** ON Semiconductor, Japan Customer Focus Center  
4-32-1 Nishi-Gotanda, Shinagawa-ku, Tokyo, Japan 141-0031  
**Phone:** 81-3-5740-2700  
**Email:** r14525@onsemi.com

**ON Semiconductor Website:** <http://onsemi.com>

For additional information, please contact your local Sales Representative.



LittleDiode supplies new, hard to find or obsolete electronic components and semiconductors all over the world.

With over two million different components listed you are sure to find the part you need.

Feel free to visit us today at our online store:

[LittleDiode.com](http://LittleDiode.com)

Looking forward to providing you with the best possible service.