

JFET Amplifiers

P-Channel — Depletion

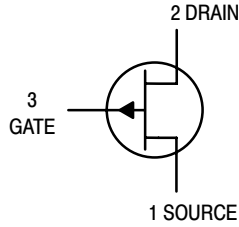

2N5460
2N5461
2N5462

MAXIMUM RATINGS

Rating	Symbol	Value	Unit
Drain–Gate Voltage	V_{DG}	40	Vdc
Reverse Gate–Source Voltage	V_{GSR}	40	Vdc
Forward Gate Current	$I_{G(f)}$	10	mAdc
Total Device Dissipation @ $T_A = 25^\circ\text{C}$ Derate above 25°C	P_D	350 2.8	mW mW/°C
Junction Temperature Range	T_J	-65 to +135	°C
Storage Channel Temperature Range	T_{stg}	-65 to +150	°C

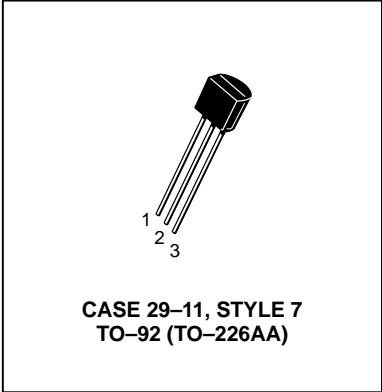

ELECTRICAL CHARACTERISTICS ($T_A = 25^\circ\text{C}$ unless otherwise noted)

Characteristic	Symbol	Min	Typ	Max	Unit
OFF CHARACTERISTICS					
Gate–Source Breakdown Voltage ($I_G = 10 \mu\text{Adc}$, $V_{DS} = 0$)	$V_{(BR)GSS}$	40	—	—	Vdc
Gate Reverse Current ($V_{GS} = 20 \text{ Vdc}$, $V_{DS} = 0$)	I_{GSS}	—	—	5.0	nAdc
($V_{GS} = 30 \text{ Vdc}$, $V_{DS} = 0$)		—	—	1.0	μAdc
($V_{GS} = 20 \text{ Vdc}$, $V_{DS} = 0$, $T_A = 100^\circ\text{C}$)		—	—	1.0	μAdc
($V_{GS} = 30 \text{ Vdc}$, $V_{DS} = 0$, $T_A = 100^\circ\text{C}$)		—	—	1.0	μAdc
Gate–Source Cutoff Voltage ($V_{DS} = 15 \text{ Vdc}$, $I_D = 1.0 \mu\text{Adc}$)	$V_{GS(off)}$	0.75 1.0 1.8	— — —	6.0 7.5 9.0	Vdc
Gate–Source Voltage ($V_{DS} = 15 \text{ Vdc}$, $I_D = 0.1 \text{ mAdc}$)	V_{GS}	0.5	—	4.0	Vdc
($V_{DS} = 15 \text{ Vdc}$, $I_D = 0.2 \text{ mAdc}$)		0.8	—	4.5	Vdc
($V_{DS} = 15 \text{ Vdc}$, $I_D = 0.4 \text{ mAdc}$)		1.5	—	6.0	Vdc

2N5460 2N5461 2N5462

ELECTRICAL CHARACTERISTICS (T_A = 25°C unless otherwise noted)

Characteristic		Symbol	Min	Typ	Max	Unit
ON CHARACTERISTICS						
Zero-Gate-Voltage Drain Current (V _{DS} = 15 Vdc, V _{GS} = 0, f = 1.0 kHz)	2N5460	I _{DSS}	-1.0	—	-5.0	mAdc
	2N5461		-2.0	—	-9.0	
	2N5462		-4.0	—	-16	
SMALL-SIGNAL CHARACTERISTICS						
Forward Transfer Admittance (V _{DS} = 15 Vdc, V _{GS} = 0, f = 1.0 kHz)	2N5460	y _{fs}	1000	—	4000	μmhos
	2N5461		1500	—	5000	
	2N5462		2000	—	6000	
Output Admittance (V _{DS} = 15 Vdc, V _{GS} = 0, f = 1.0 kHz)		y _{os}	—	—	75	μmhos
Input Capacitance (V _{DS} = 15 Vdc, V _{GS} = 0, f = 1.0 MHz)		C _{iSS}	—	5.0	7.0	pF
Reverse Transfer Capacitance (V _{DS} = 15 Vdc, V _{GS} = 0, f = 1.0 MHz)		C _{rSS}	—	1.0	2.0	pF
FUNCTIONAL CHARACTERISTICS						
Equivalent Short-Circuit Input Noise Voltage (V _{DS} = 15 Vdc, V _{GS} = 0, f = 100 Hz, BW = 1.0 Hz)		e _n	—	60	115	nV/√Hz

DRAIN CURRENT versus GATE SOURCE VOLTAGE

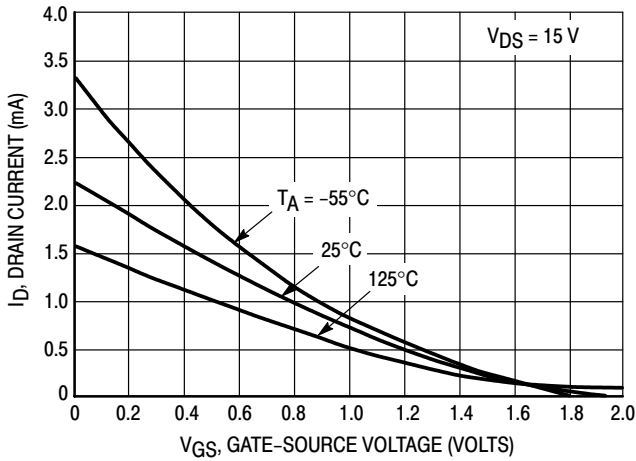

Figure 1. $V_{GS(off)} = 2.0$ Volts

FORWARD TRANSFER ADMITTANCE versus DRAIN CURRENT

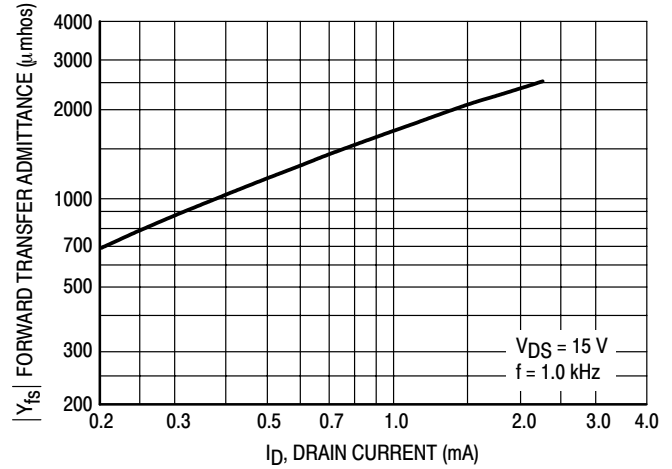

Figure 4. $V_{GS(off)} = 2.0$ Volts

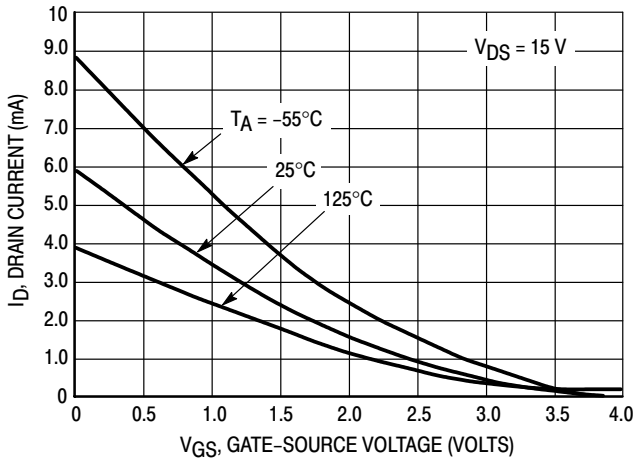

Figure 2. $V_{GS(off)} = 4.0$ Volts

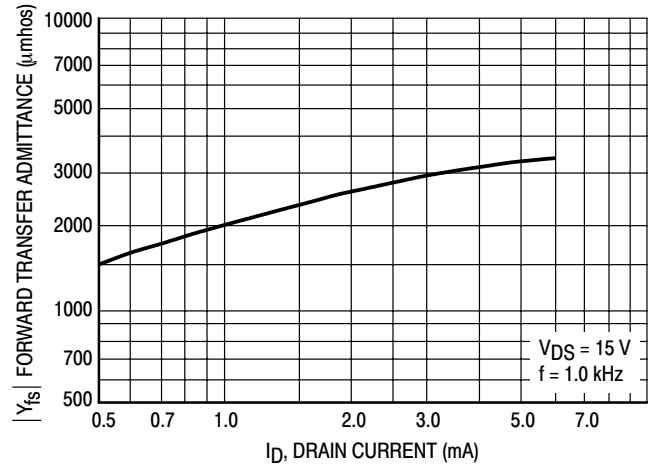

Figure 5. $V_{GS(off)} = 4.0$ Volts

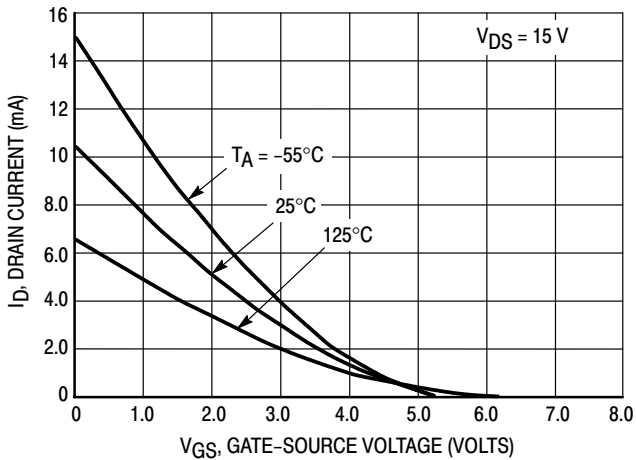

Figure 3. $V_{GS(off)} = 5.0$ Volts

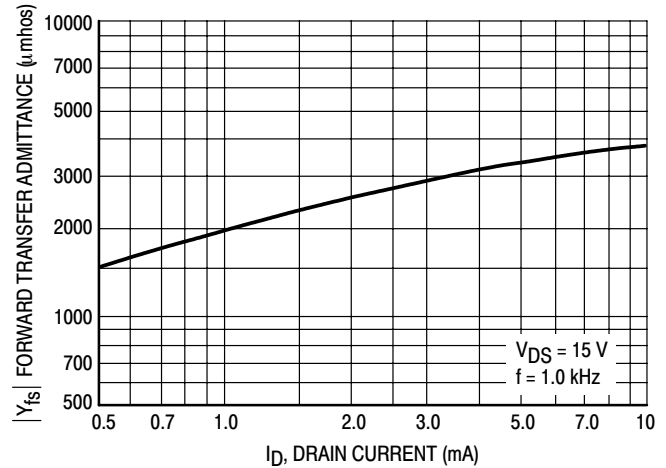

Figure 6. $V_{GS(off)} = 5.0$ Volts

2N5460 2N5461 2N5462

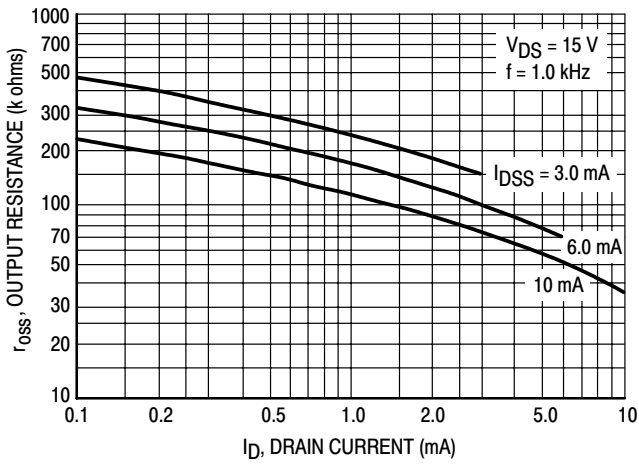

Figure 7. Output Resistance versus Drain Current

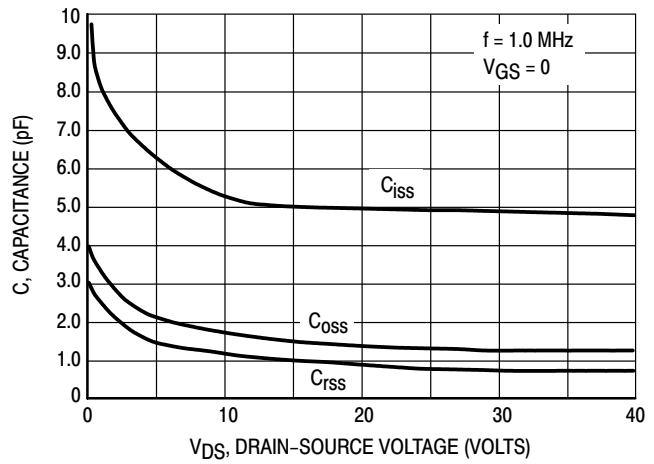

Figure 8. Capacitance versus Drain-Source Voltage

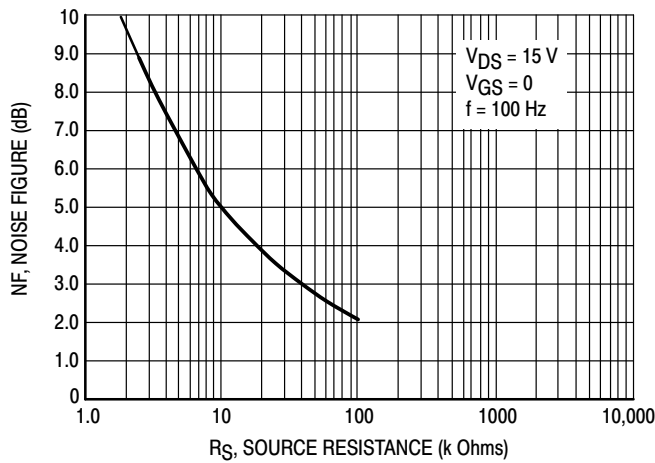
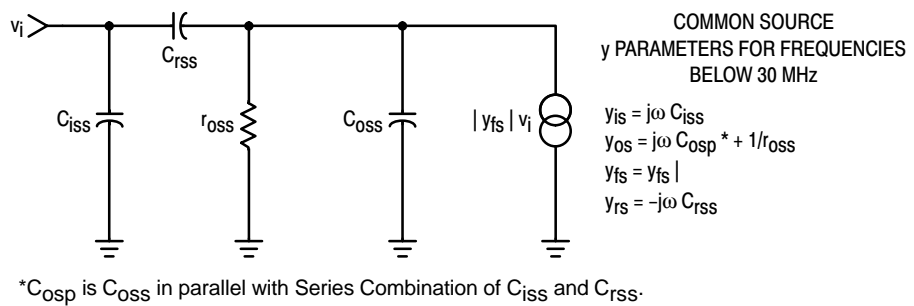

Figure 9. Noise Figure versus Source Resistance



NOTE:

1. Graphical data is presented for dc conditions. Tabular data is given for pulsed conditions (Pulse Width = 630 ms, Duty Cycle = 10%).

Figure 10. Equivalent Low Frequency Circuit

2N5460 2N5461 2N5462

PACKAGE DIMENSIONS

TO-92 (TO-226AA)
CASE 29-11
ISSUE AL

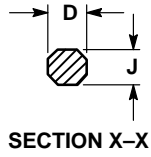
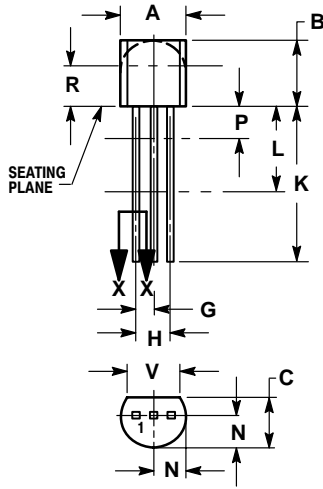

STYLE 7:
PIN 1. SOURCE
2. DRAIN
3. GATE

NOTES:

1. DIMENSIONING AND TOLERANCING PER ANSI Y14.5M, 1982.
2. CONTROLLING DIMENSION: INCH.
3. CONTOUR OF PACKAGE BEYOND DIMENSION R IS UNCONTROLLED.
4. LEAD DIMENSION IS UNCONTROLLED IN P AND BEYOND DIMENSION K MINIMUM.

DIM	INCHES		MILLIMETERS	
	MIN	MAX	MIN	MAX
A	0.175	0.205	4.45	5.20
B	0.170	0.210	4.32	5.33
C	0.125	0.165	3.18	4.19
D	0.016	0.021	0.407	0.533
G	0.045	0.055	1.15	1.39
H	0.095	0.105	2.42	2.66
J	0.015	0.020	0.39	0.50
K	0.500	---	12.70	---
L	0.250	---	6.35	---
N	0.080	0.105	2.04	2.66
P	---	0.100	---	2.54
R	0.115	---	2.93	---
V	0.135	---	3.43	---

Notes

Notes

ON Semiconductor and  are trademarks of Semiconductor Components Industries, LLC (SCILLC). SCILLC reserves the right to make changes without further notice to any products herein. SCILLC makes no warranty, representation or guarantee regarding the suitability of its products for any particular purpose, nor does SCILLC assume any liability arising out of the application or use of any product or circuit, and specifically disclaims any and all liability, including without limitation special, consequential or incidental damages. "Typical" parameters which may be provided in SCILLC data sheets and/or specifications can and do vary in different applications and actual performance may vary over time. All operating parameters, including "Typicals" must be validated for each customer application by customer's technical experts. SCILLC does not convey any license under its patent rights nor the rights of others. SCILLC products are not designed, intended, or authorized for use as components in systems intended for surgical implant into the body, or other applications intended to support or sustain life, or for any other application in which the failure of the SCILLC product could create a situation where personal injury or death may occur. Should Buyer purchase or use SCILLC products for any such unintended or unauthorized application, Buyer shall indemnify and hold SCILLC and its officers, employees, subsidiaries, affiliates, and distributors harmless against all claims, costs, damages, and expenses, and reasonable attorney fees arising out of, directly or indirectly, any claim of personal injury or death associated with such unintended or unauthorized use, even if such claim alleges that SCILLC was negligent regarding the design or manufacture of the part. SCILLC is an Equal Opportunity/Affirmative Action Employer.

PUBLICATION ORDERING INFORMATION

Literature Fulfillment:

Literature Distribution Center for ON Semiconductor
P.O. Box 5163, Denver, Colorado 80217 USA
Phone: 303-675-2175 or 800-344-3860 Toll Free USA/Canada
Fax: 303-675-2176 or 800-344-3867 Toll Free USA/Canada
Email: ONlit@hibbertco.com

N. American Technical Support: 800-282-9855 Toll Free USA/Canada

JAPAN: ON Semiconductor, Japan Customer Focus Center
4-32-1 Nishi-Gotanda, Shinagawa-ku, Tokyo, Japan 141-0031
Phone: 81-3-5740-2700
Email: r14525@onsemi.com

ON Semiconductor Website: <http://onsemi.com>

For additional information, please contact your local Sales Representative.



LittleDiode supplies new, hard to find or obsolete electronic components and semiconductors all over the world.

With over two million different components listed you are sure to find the part you need.

Feel free to visit us today at our online store:

LittleDiode.com

Looking forward to providing you with the best possible service.