

General Purpose Transistors

PNP Silicon

2N3905
2N3906*

*Motorola Preferred Device

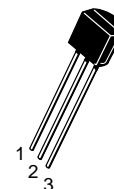
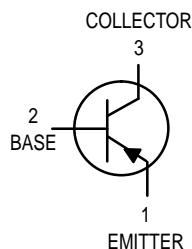

CASE 29-04, STYLE 1
TO-92 (TO-226AA)

MAXIMUM RATINGS

Rating	Symbol	Value	Unit
Collector–Emitter Voltage	V_{CEO}	40	Vdc
Collector–Base Voltage	V_{CBO}	40	Vdc
Emitter–Base Voltage	V_{EBO}	5.0	Vdc
Collector Current — Continuous	I_C	200	mAdc
Total Device Dissipation @ $T_A = 25^\circ\text{C}$ Derate above 25°C	P_D	625 5.0	mW mW/ $^\circ\text{C}$
Total Power Dissipation @ $T_A = 60^\circ\text{C}$	P_D	250	mW
Total Device Dissipation @ $T_C = 25^\circ\text{C}$ Derate above 25°C	P_D	1.5 12	Watts mW/ $^\circ\text{C}$
Operating and Storage Junction Temperature Range	T_J, T_{stg}	-55 to +150	$^\circ\text{C}$

THERMAL CHARACTERISTICS(1)

Characteristic	Symbol	Max	Unit
Thermal Resistance, Junction to Ambient	$R_{\theta JA}$	200	$^\circ\text{C}/\text{W}$
Thermal Resistance, Junction to Case	$R_{\theta JC}$	83.3	$^\circ\text{C}/\text{W}$

ELECTRICAL CHARACTERISTICS ($T_A = 25^\circ\text{C}$ unless otherwise noted)

Characteristic	Symbol	Min	Max	Unit
----------------	--------	-----	-----	------

OFF CHARACTERISTICS

Collector–Emitter Breakdown Voltage (2) ($I_C = 1.0 \text{ mAdc}, I_B = 0$)	$V_{(BR)CEO}$	40	—	Vdc
Collector–Base Breakdown Voltage ($I_C = 10 \mu\text{Adc}, I_E = 0$)	$V_{(BR)CBO}$	40	—	Vdc
Emitter–Base Breakdown Voltage ($I_E = 10 \mu\text{Adc}, I_C = 0$)	$V_{(BR)EBO}$	5.0	—	Vdc
Base Cutoff Current ($V_{CE} = 30 \text{ Vdc}, V_{EB} = 3.0 \text{ Vdc}$)	I_{BL}	—	50	nAdc
Collector Cutoff Current ($V_{CE} = 30 \text{ Vdc}, V_{EB} = 3.0 \text{ Vdc}$)	I_{CEX}	—	50	nAdc

1. Indicates Data in addition to JEDEC Requirements.
2. Pulse Test: Pulse Width $\leq 300 \mu\text{s}$; Duty Cycle $\leq 2.0\%$.

Preferred devices are Motorola recommended choices for future use and best overall value.

REV 2

2N3905 2N3906

ELECTRICAL CHARACTERISTICS ($T_A = 25^\circ\text{C}$ unless otherwise noted) (Continued)

Characteristic	Symbol	Min	Max	Unit
ON CHARACTERISTICS(1)				
DC Current Gain ($I_C = 0.1 \text{ mAdc}$, $V_{CE} = 1.0 \text{ Vdc}$)	h_{FE}	30	—	—
2N3905		60	—	
2N3906				
($I_C = 1.0 \text{ mAdc}$, $V_{CE} = 1.0 \text{ Vdc}$)		40	—	
2N3905		80	—	
2N3906				
($I_C = 10 \text{ mAdc}$, $V_{CE} = 1.0 \text{ Vdc}$)		50	150	
2N3905		100	300	
2N3906				
($I_C = 50 \text{ mAdc}$, $V_{CE} = 1.0 \text{ Vdc}$)		30	—	
2N3905		60	—	
2N3906				
($I_C = 100 \text{ mAdc}$, $V_{CE} = 1.0 \text{ Vdc}$)		15	—	
2N3905		30	—	
2N3906				
Collector–Emitter Saturation Voltage ($I_C = 10 \text{ mAdc}$, $I_B = 1.0 \text{ mAdc}$) ($I_C = 50 \text{ mAdc}$, $I_B = 5.0 \text{ mAdc}$)	$V_{CE(sat)}$	—	0.25 0.4	Vdc
Base–Emitter Saturation Voltage ($I_C = 10 \text{ mAdc}$, $I_B = 1.0 \text{ mAdc}$) ($I_C = 50 \text{ mAdc}$, $I_B = 5.0 \text{ mAdc}$)	$V_{BE(sat)}$	0.65 —	0.85 0.95	Vdc

SMALL–SIGNAL CHARACTERISTICS

Current–Gain — Bandwidth Product ($I_C = 10 \text{ mAdc}$, $V_{CE} = 20 \text{ Vdc}$, $f = 100 \text{ MHz}$)	f_T	200 250	— —	MHz
Output Capacitance ($V_{CB} = 5.0 \text{ Vdc}$, $I_E = 0$, $f = 1.0 \text{ MHz}$)	C_{obo}	—	4.5	pF
Input Capacitance ($V_{EB} = 0.5 \text{ Vdc}$, $I_C = 0$, $f = 1.0 \text{ MHz}$)	C_{ibo}	—	10.0	pF
Input Impedance ($I_C = 1.0 \text{ mAdc}$, $V_{CE} = 10 \text{ Vdc}$, $f = 1.0 \text{ kHz}$)	h_{ie}	0.5 2.0	8.0 12	k Ω
Voltage Feedback Ratio ($I_C = 1.0 \text{ mAdc}$, $V_{CE} = 10 \text{ Vdc}$, $f = 1.0 \text{ kHz}$)	h_{re}	0.1 0.1	5.0 10	$\times 10^{-4}$
Small–Signal Current Gain ($I_C = 1.0 \text{ mAdc}$, $V_{CE} = 10 \text{ Vdc}$, $f = 1.0 \text{ kHz}$)	h_{fe}	50 100	200 400	—
Output Admittance ($I_C = 1.0 \text{ mAdc}$, $V_{CE} = 10 \text{ Vdc}$, $f = 1.0 \text{ kHz}$)	h_{oe}	1.0 3.0	40 60	μhos
Noise Figure ($I_C = 100 \mu\text{Adc}$, $V_{CE} = 5.0 \text{ Vdc}$, $R_S = 1.0 \text{ k } \Omega$, $f = 1.0 \text{ kHz}$)	NF	— —	5.0 4.0	dB

SWITCHING CHARACTERISTICS

Delay Time	$(V_{CC} = 3.0 \text{ Vdc}$, $V_{BE} = 0.5 \text{ Vdc}$, $I_C = 10 \text{ mAdc}$, $I_{B1} = 1.0 \text{ mAdc}$)	t_d	—	35	ns
Rise Time		t_r	—	35	ns
Storage Time	$(V_{CC} = 3.0 \text{ Vdc}$, $I_C = 10 \text{ mAdc}$, $I_{B1} = I_{B2} = 1.0 \text{ mAdc}$)	t_s	— —	200 225	ns
Fall Time		t_f	— —	60 75	ns

1. Pulse Test: Pulse Width $\leq 300 \mu\text{s}$; Duty Cycle $\leq 2.0\%$.

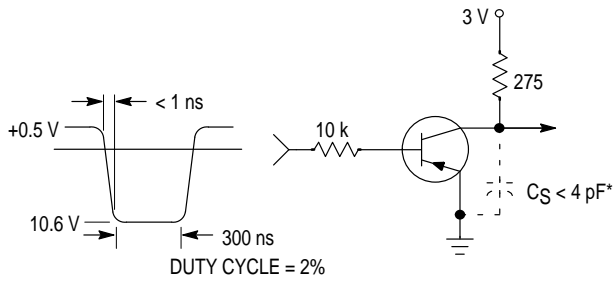

Figure 1. Delay and Rise Time Equivalent Test Circuit

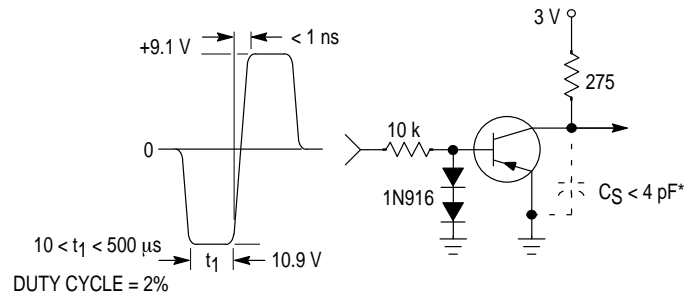

Figure 2. Storage and Fall Time Equivalent Test Circuit

* Total shunt capacitance of test jig and connectors

TYPICAL TRANSIENT CHARACTERISTICS

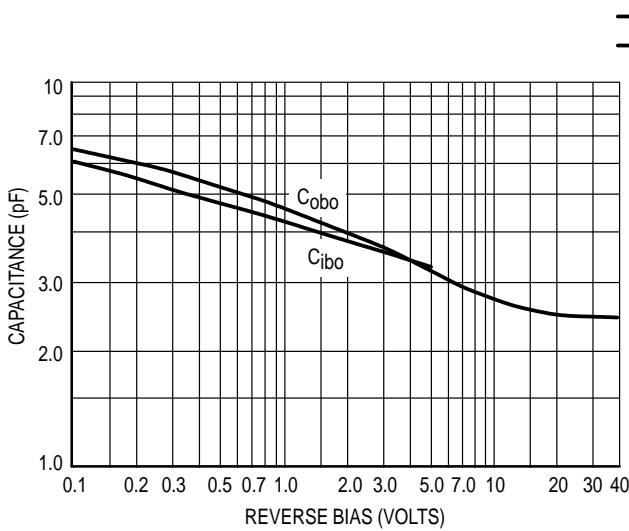

Figure 3. Capacitance

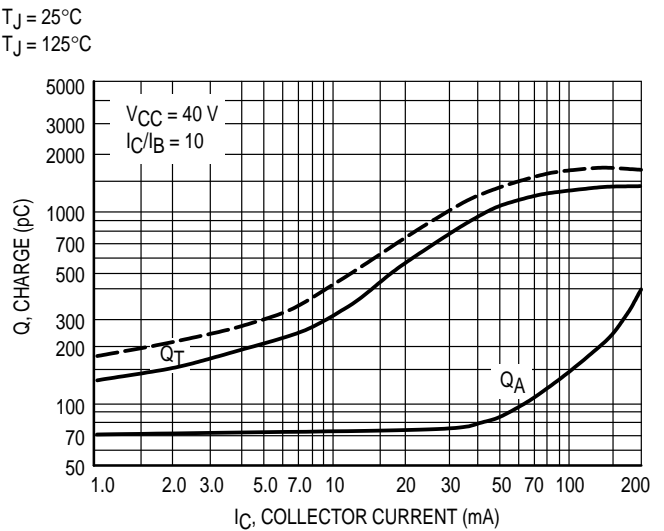

Figure 4. Charge Data

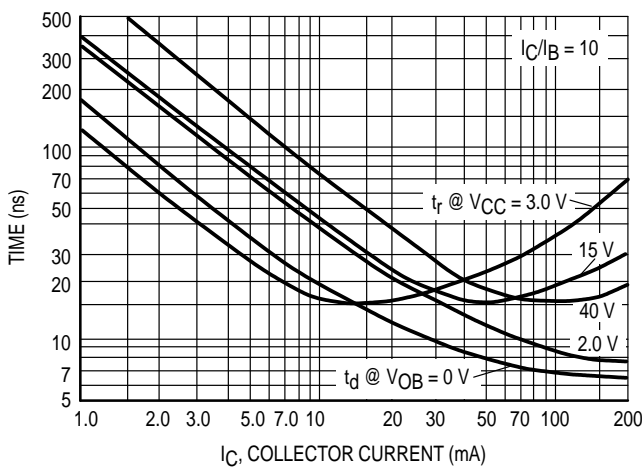

Figure 5. Turn-On Time

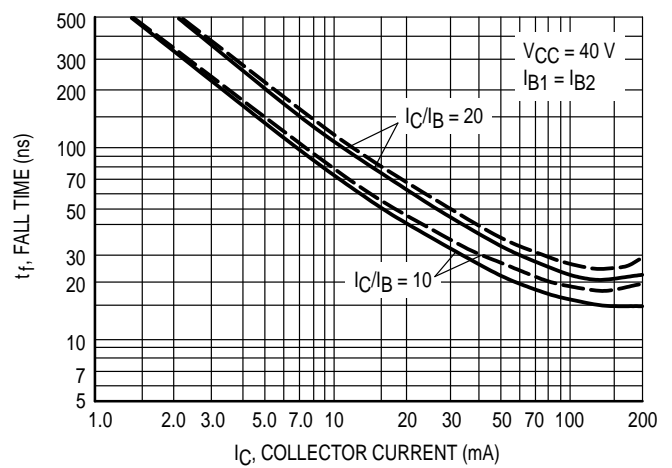

Figure 6. Fall Time

**TYPICAL AUDIO SMALL-SIGNAL CHARACTERISTICS
NOISE FIGURE VARIATIONS**

($V_{CE} = -5.0$ Vdc, $T_A = 25^\circ\text{C}$, Bandwidth = 1.0 Hz)

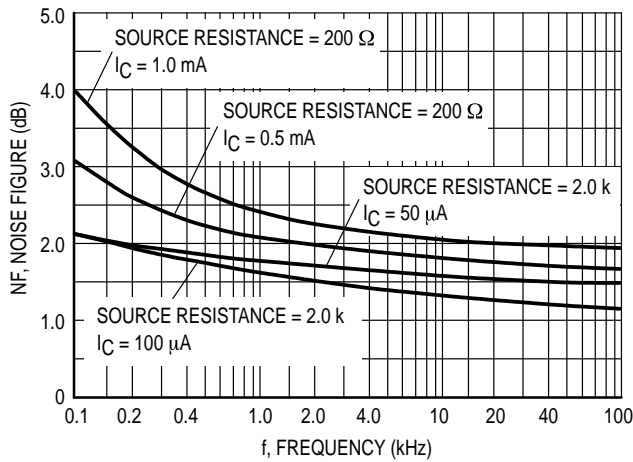

Figure 7.

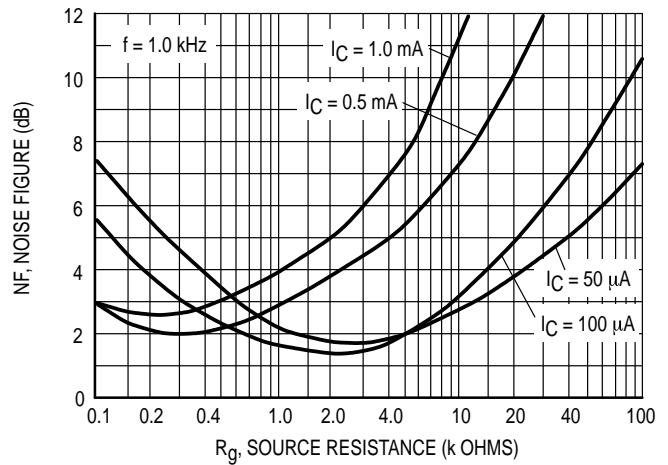

Figure 8.

h PARAMETERS

($V_{CE} = -10$ Vdc, $f = 1.0$ kHz, $T_A = 25^\circ\text{C}$)

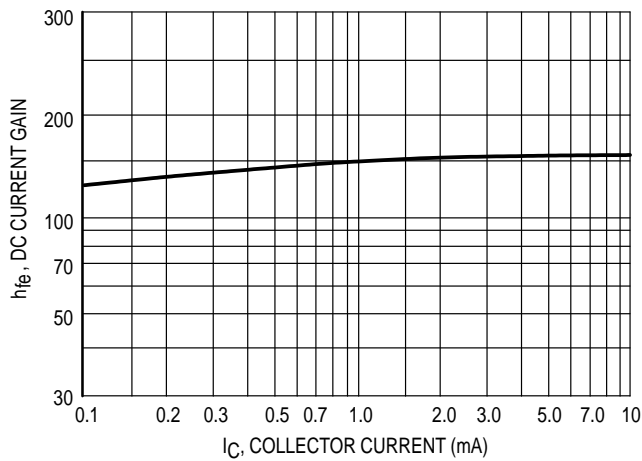

Figure 9. Current Gain

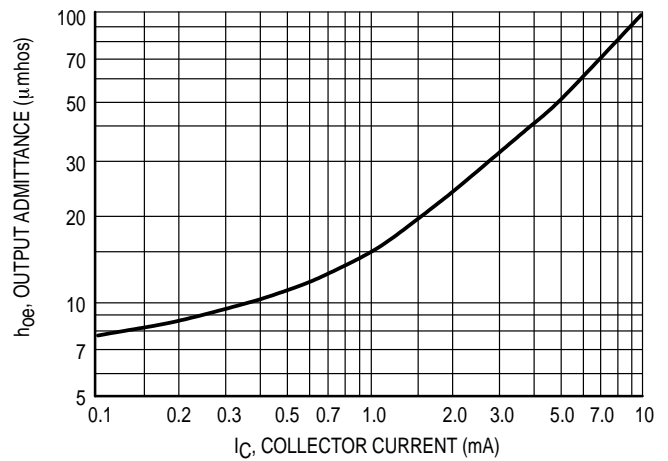

Figure 10. Output Admittance

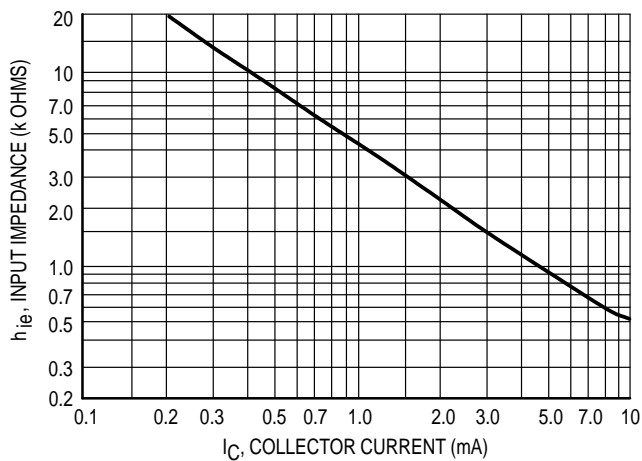

Figure 11. Input Impedance

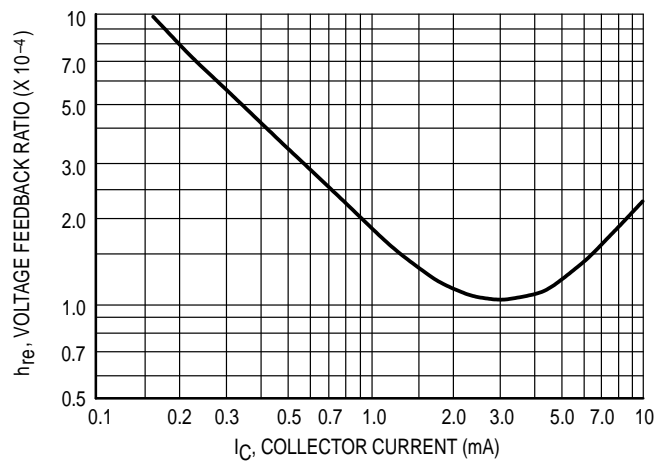

Figure 12. Voltage Feedback Ratio

TYPICAL STATIC CHARACTERISTICS

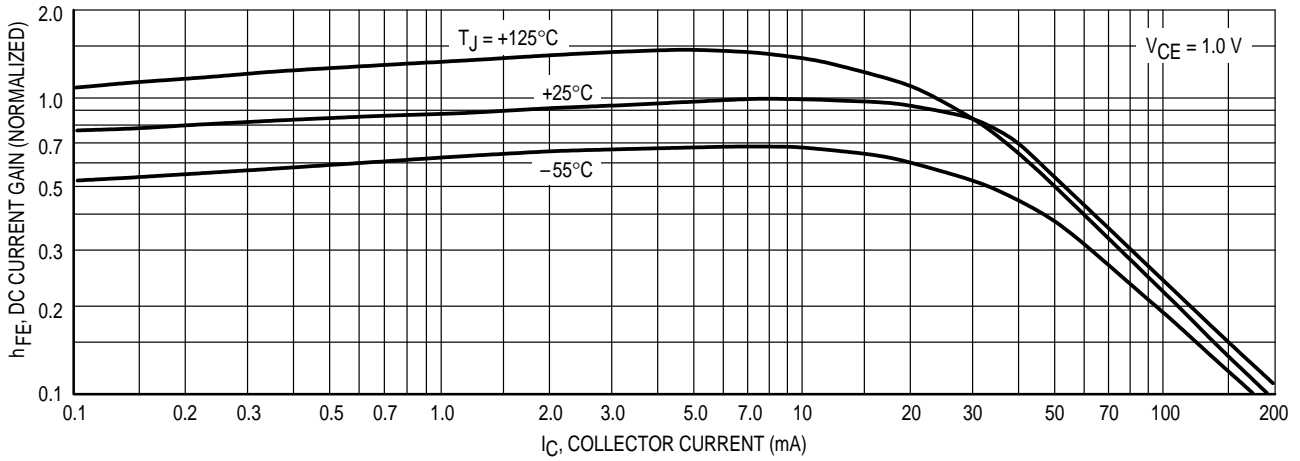

Figure 13. DC Current Gain

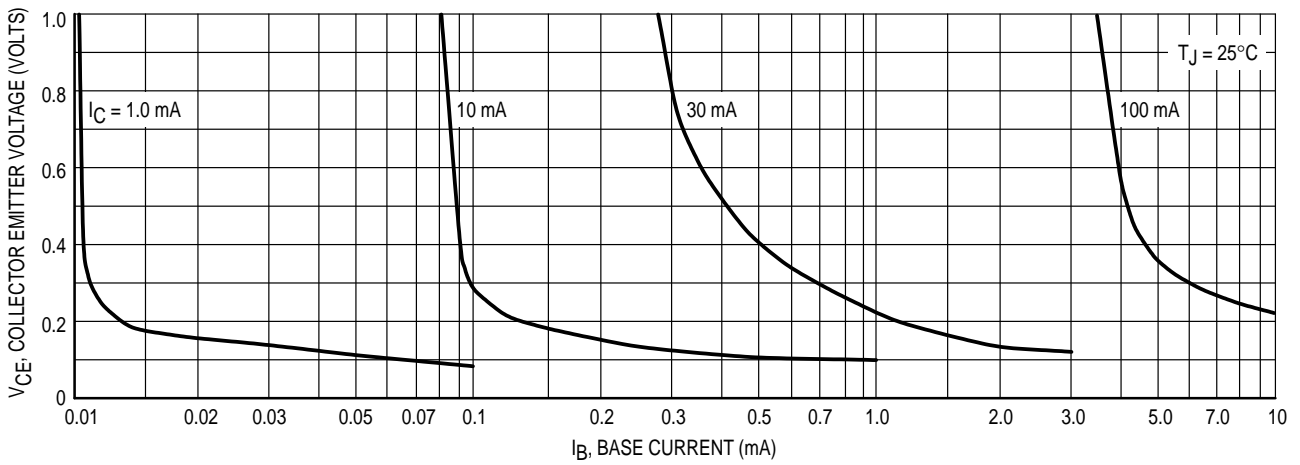

Figure 14. Collector Saturation Region

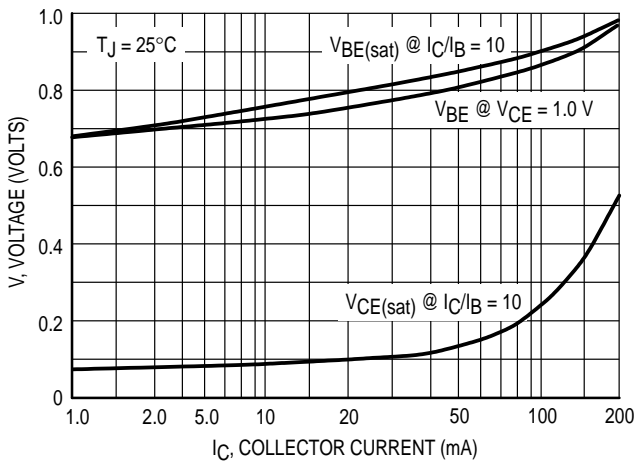

Figure 15. "ON" Voltages

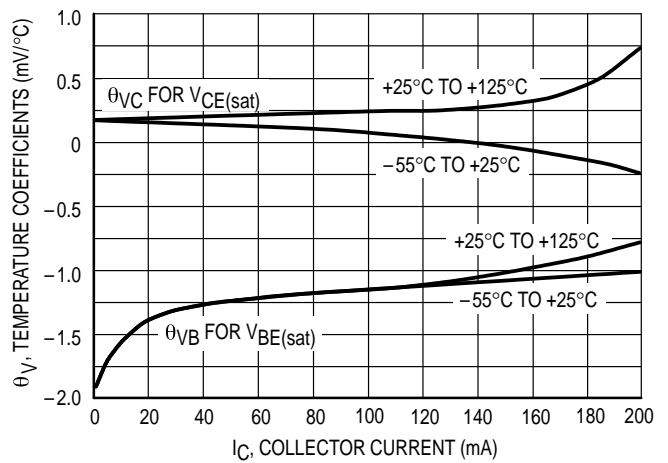
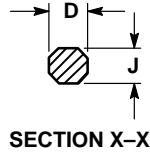
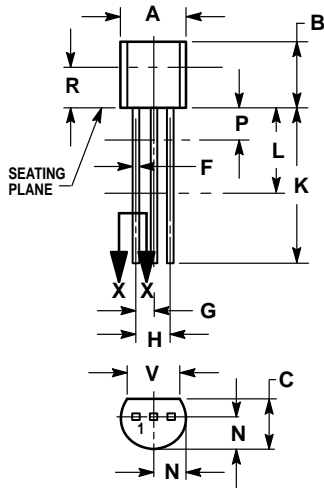

Figure 16. Temperature Coefficients

PACKAGE DIMENSIONS



CASE 029-04
(TO-226AA)
ISSUE AD

NOTES:

1. DIMENSIONING AND TOLERANCING PER ANSI Y14.5M, 1982.
2. CONTROLLING DIMENSION: INCH.
3. CONTOUR OF PACKAGE BEYOND DIMENSION R IS UNCONTROLLED.
4. DIMENSION F APPLIES BETWEEN P AND L. DIMENSION D AND J APPLY BETWEEN L AND K. MINIMUM LEAD DIMENSION IS UNCONTROLLED IN P AND BEYOND DIMENSION K MINIMUM.

DIM	INCHES		MILLIMETERS	
	MIN	MAX	MIN	MAX
A	0.175	0.205	4.45	5.20
B	0.170	0.210	4.32	5.33
C	0.125	0.165	3.18	4.19
D	0.016	0.022	0.41	0.55
F	0.016	0.019	0.41	0.48
G	0.045	0.055	1.15	1.39
H	0.095	0.105	2.42	2.66
J	0.015	0.020	0.39	0.50
K	0.500	—	12.70	—
L	0.250	—	6.35	—
N	0.080	0.105	2.04	2.66
P	—	0.100	—	2.54
R	0.115	—	2.93	—
V	0.135	—	3.43	—

STYLE 1:

- PIN 1. EMITTER
2. BASE
3. COLLECTOR

Motorola reserves the right to make changes without further notice to any products herein. Motorola makes no warranty, representation or guarantee regarding the suitability of its products for any particular purpose, nor does Motorola assume any liability arising out of the application or use of any product or circuit, and specifically disclaims any and all liability, including without limitation consequential or incidental damages. "Typical" parameters which may be provided in Motorola data sheets and/or specifications can and do vary in different applications and actual performance may vary over time. All operating parameters, including "Typicals" must be validated for each customer application by customer's technical experts. Motorola does not convey any license under its patent rights nor the rights of others. Motorola products are not designed, intended, or authorized for use as components in systems intended for surgical implant into the body, or other applications intended to support or sustain life, or for any other application in which the failure of the Motorola product could create a situation where personal injury or death may occur. Should Buyer purchase or use Motorola products for any such unintended or unauthorized application, Buyer shall indemnify and hold Motorola and its officers, employees, subsidiaries, affiliates, and distributors harmless against all claims, costs, damages, and expenses, and reasonable attorney fees arising out of, directly or indirectly, any claim of personal injury or death associated with such unintended or unauthorized use, even if such claim alleges that Motorola was negligent regarding the design or manufacture of the part. Motorola and are registered trademarks of Motorola, Inc. Motorola, Inc. is an Equal Opportunity/Affirmative Action Employer.

How to reach us:

USA/EUROPE/Locations Not Listed: Motorola Literature Distribution; P.O. Box 20912; Phoenix, Arizona 85036. 1-800-441-2447 or 602-303-5454

JAPAN: Nippon Motorola Ltd.; Tatsumi-SPD-JLDC, 6F Seibu-Butsuryu-Center, 3-14-2 Tatsumi Koto-Ku, Tokyo 135, Japan. 03-81-3521-8315

MFAX: RMFAX0@email.sps.mot.com – TOUCHTONE 602-244-6609
INTERNET: http://Design-NET.com

ASIA/PACIFIC: Motorola Semiconductors H.K. Ltd.; 8B Tai Ping Industrial Park, 51 Ting Kok Road, Tai Po, N.T., Hong Kong. 852-26629298





LittleDiode supplies new, hard to find or obsolete electronic components and semiconductors all over the world.

With over two million different components listed you are sure to find the part you need.

Feel free to visit us today at our online store:

LittleDiode.com

Looking forward to providing you with the best possible service.