

INTERNATIONAL RECTIFIER



1N3288, 1N3288A SERIES

100 Amp Avg Silicon Rectifier Diodes

Major Ratings and Characteristics

	1N3288	1N3288A	Units
$I_{F(AV)}$	100*	100*	A
@ Max. T_C	130	130	$^{\circ}C$
I_{FSM} @ 50 Hz	1550	2200	A
@ 60 Hz	1600*	2300*	
I^2t @ 50 Hz	11,500	24,000	A^2s
@ 60 Hz	10,500	22,000	
$I^2\sqrt{t}$	165,000	340,000	$A^2\sqrt{s}$
V_{RRM} Range	100 -1200	100 -1200	V

*JEDEC registered values.

Description and Features

- Reverse voltage ratings up to 1200 volts
- High surge rating series (2,300A)
- DO-8 hermetically sealed package
- Superior reliability under extreme conditions
- Can be supplied to meet stringent military, aerospace and other high-reliability requirements

CASE STYLE AND DIMENSIONS

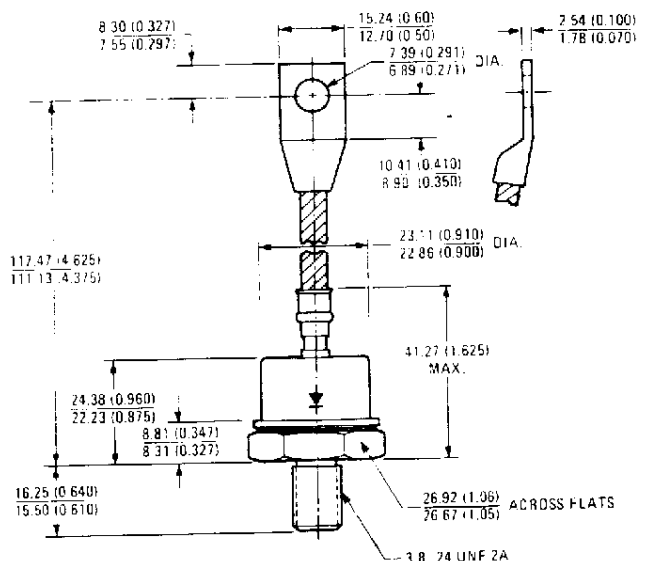
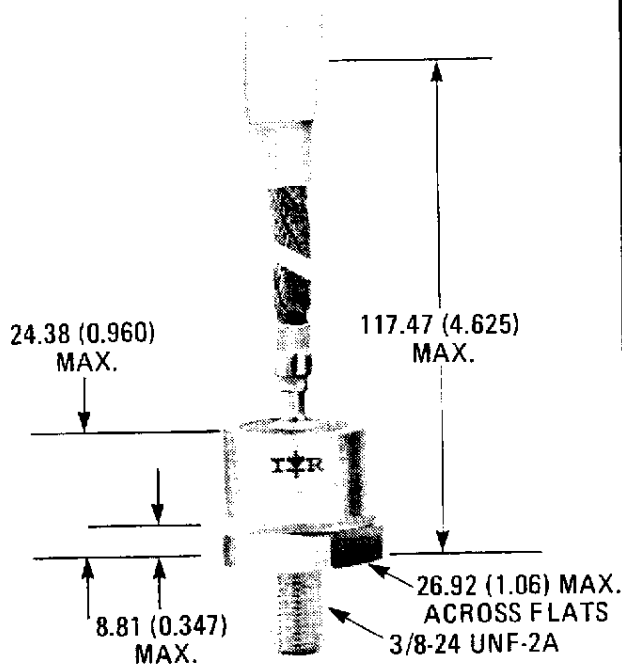

Conforms to JEDEC outline DO-205AA (DO-8) (IR B-15)

All Dimensions in Millimeters and (Inches)

VOLTAGE RATINGS

	VRRM – Max. Repetitive Peak Reverse Voltage (V)	VRSM – Max. Non-repetitive Peak Reverse Voltage (V)	VR – Max. Direct Reverse Voltage (V)	IRRM – Max. Peak Reverse Current Max. Rated IF(AV) and VRRM 1 Phase Operation (mA)
Part Number ①	TC = -40°C to 200°C ②	TC = 25°C to 200°C	TC = -40°C to 200°C ②	TC = 130°C
1N3288 1N3288A	100*	200*	100*	24*
1N3289 1N3289A	200*	300*	200*	24*
1N3290 1N3290A	300*	400*	300*	24*
1N3291 1N3291A	400*	525*	400*	24*
1N3292 1N3292B	500*	650*	500*	21*
1N3293 1N3293A	600*	800*	600*	17*
1N3294 1N3294A	800*	1050*	800*	13*
1N3295 1N3295A	1000*	1300*	1000*	11*
1N3296 1N3296A	1200*	1600*	1200*	9*

① Basic number indicates cathode-to-case. For anode-to-case, add "R" to part number, e.g., 1N3291RA

ELECTRICAL SPECIFICATIONS

	1N3288	1N3288A ③	Units	Conditions
IF(AV) Max. average forward current	100*	100*	A	180° sinusoidal conduction. Max. TC = 130°C*
IFSM Max. peak one-cycle non-repetitive surge current	1550	2200	A	Half cycle 50 Hz sine wave or 6 ms rectangular pulse Following any rated load condition and with rated VRRM applied.
	1600	2300		
	1800	2600		Half cycle 50 Hz sine wave or 6 ms rectangular pulse Following any rated load condition and with VRRM applied following surge = 0.
	1900	2750		
I2t Max. I2t for fusing	11,500	24,000	A2s	t = 10 ms With rated VRRM applied following surge, initial TJ = 200°C
	10,500	22,000		t = 8.3 ms
	16,500	34,000		t = 10 ms With VRRM = 0 following surge, initial TJ = 200°C
				t = 8.3 ms
I2√t Max. I2√t for individual device ④	165,000	340,000	A2√s	t = 0.1 to 10 ms, VRRM = 0 following surge.
VFM Max. peak forward voltage	1.5*	1.5*	V	IF(AV) = 100A (314A peak), TC = 130°C

THERMAL-MECHANICAL SPECIFICATIONS

TC Max. operating case temperature range	-40° to 200° ②	°C	1N3292B: -65° to 200°C
Tstg Max. storage temperature range	-40° to 200° ①	°C	1N3292B: -65° to 200°C
RthJC Max. internal thermal resistance, junction-to-case	0.4*	deg C/W	DC operation.
RthCS Thermal resistance, case-to-sink	0.1	deg C/W	Mounting surface flat, smooth, and greased.
T Mounting torque	11.3-14.1 (100-125)	N · m (lbf-in)	Non-lubricated threads
wt Approximate weight	71 (2.5)	g (oz)	
Case style	DO-205AA (DO-8) (IR B-15)		JEDEC

*JEDEC registered values.

② Min. TC = -65°C for 1N3292B only.

④ I2t for time tx = I2√t · √tx.

③ Applies to 1N3292B.

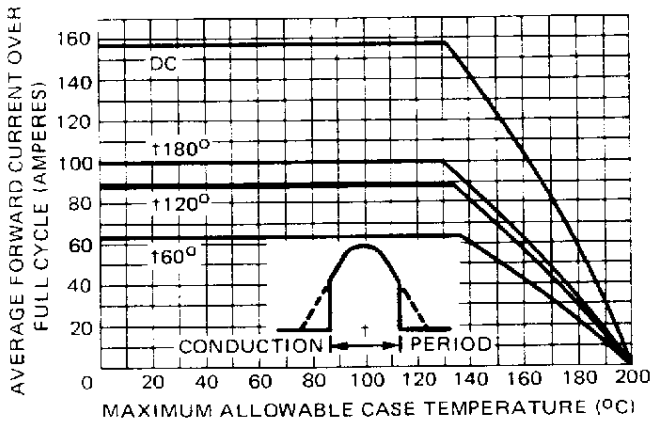

Fig. 1 – Average Forward Current Vs Case Temperature (Sinusoidal Current Waveform)

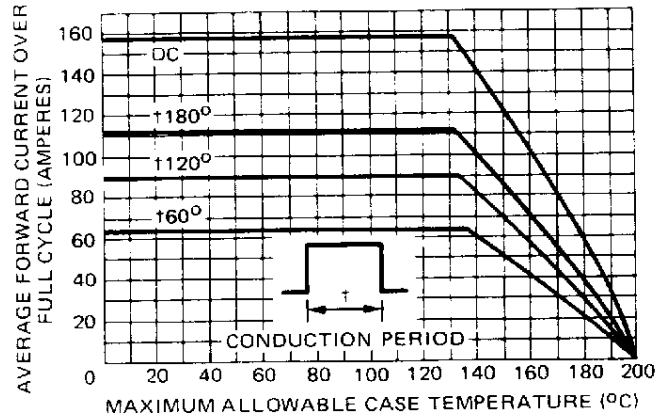

Fig. 2 – Average Forward Current Vs Case Temperature (Rectangular Current Waveform)

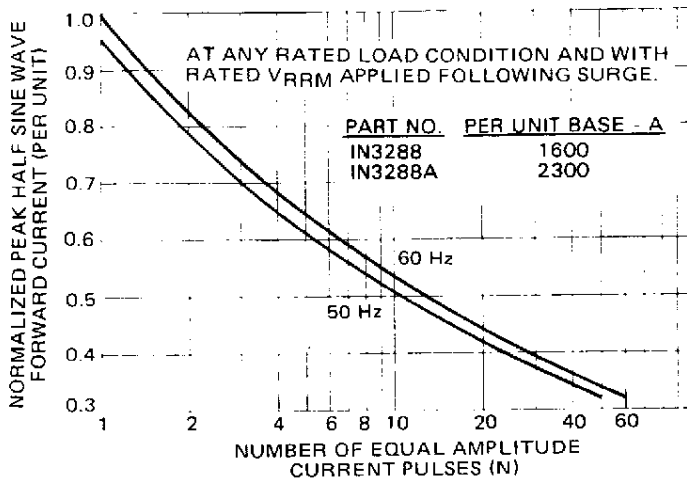

Fig. 3 – Maximum Non-Repetitive Normalized Surge Current Vs. Number of Current Pulses

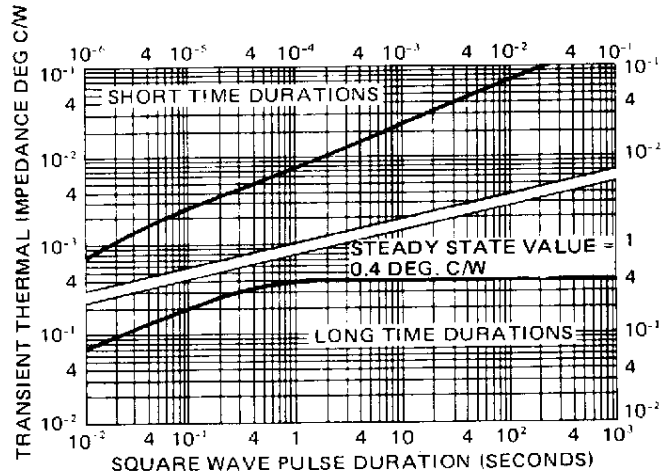

Fig. 4 – Maximum Transient Thermal Impedance, Junction-to-Case, Vs. Pulse Duration

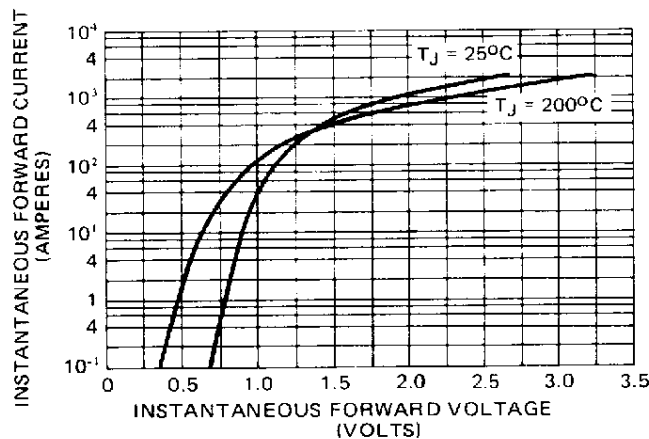

Fig. 5 – Maximum Forward Voltage Vs Forward Current

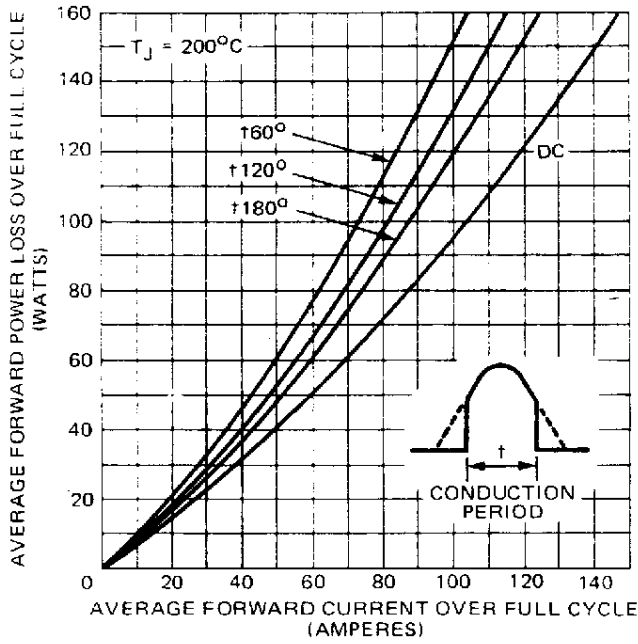

Fig. 6 — Maximum Forward Power Loss Vs Low Level Forward Current (Sinusoidal Current Waveform)

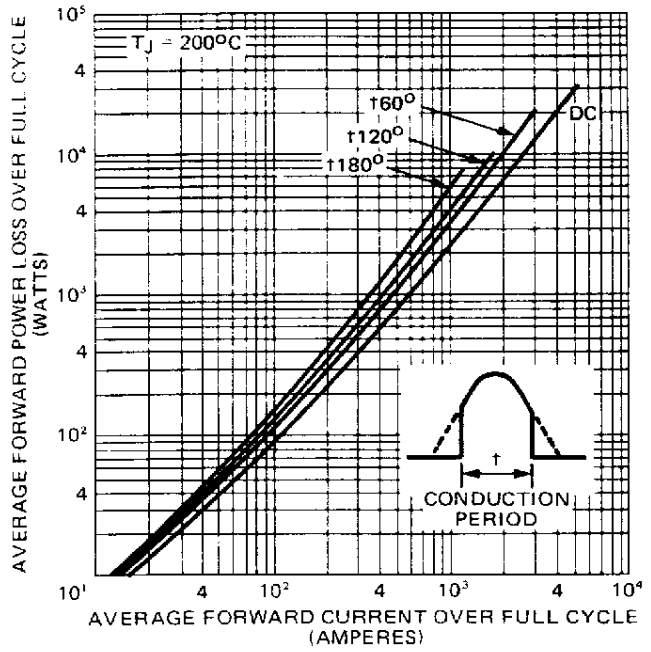

Fig. 7 — Maximum Forward Power Loss Vs High Level Forward Current (Sinusoidal Current Waveform)

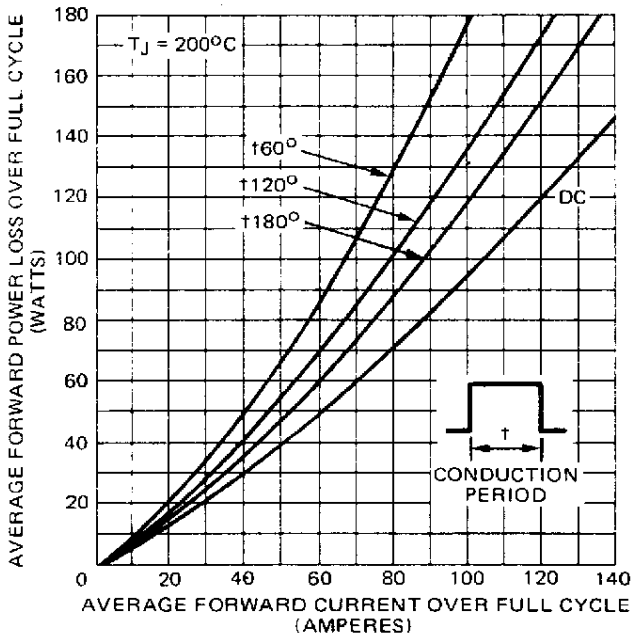

Fig. 8 — Maximum Forward Power Loss Vs High Level Forward Current (Rectangular Current Waveform)

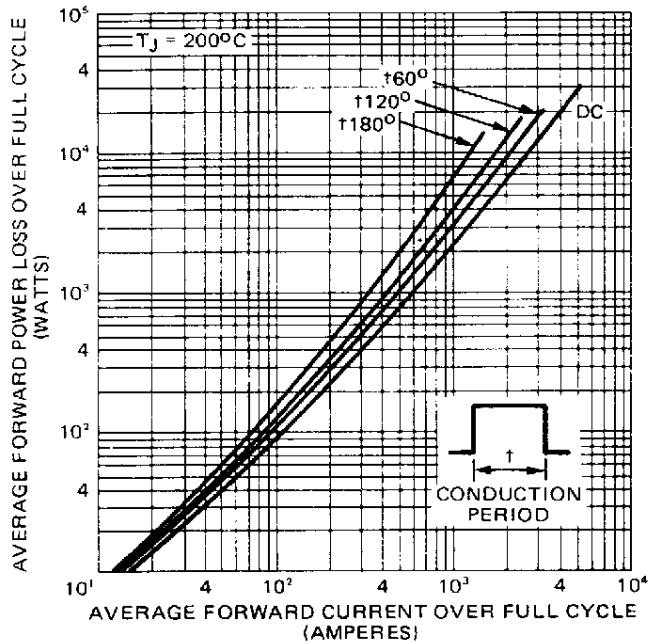

Fig. 9 — Maximum Forward Power Loss Vs High Level Forward Current (Rectangular Current Waveform)



Printed on Signet recycled offset:
made from 50% recycled waste paper, including
10% de-inked, post-consumer waste.



International
IOR Rectifier

WORLD HEADQUARTERS: 233 Kansas St., El Segundo, California 90245, Tel: (310) 322-3331, Twx: 4720403
EUROPEAN HEADQUARTERS: Hurst Green, Oxted, Surrey RH8 9BB England, Tel: (0883) 713215, Twx: 95219

IR CANADA: 101 Bentley St., Markham, Ontario L3R 3L1, Tel: (416) 475-1897. **IR GERMANY:** Saalburgstrasse 157, D-6380 Bad Homburg, Tel: 6172-37066. **IR ITALY:** Via Liguria 49
10071 Borgaro, Torino, Tel: (011) 470 1484. **IR FAR EAST:** K&H Building, 30-4 Nishiikebukuro 3-Chome, Toshima-ku, Tokyo 171 Japan, Tel: (03) 983 0641. **IR SOUTHEAST ASIA:**
190 Middle Road, HEX 10-01 Fortune Centre, Singapore 0718, Tel: (65) 336 3922.

Sales Offices, Agents and Distributors in Major Cities Throughout the World.

Printed in U.S.A. 3/94 5m

Data and specifications subject to change without notice. (1082)



LittleDiode supplies new, hard to find or obsolete electronic components and semiconductors all over the world.

With over two million different components listed you are sure to find the part you need.

Feel free to visit us today at our online store:

LittleDiode.com

Looking forward to providing you with the best possible service.