

Features

- Guard Ring Die Construction for Transient Protection
- Low Power Loss, High Efficiency
- High Surge Capability
- High Current Capability and Low Forward Voltage Drop
- **Lead Free Finish, RoHS Compliant (Note 4)**
- **"Green" Molding Compound (No Br, Sb)**
- **Qualified to AEC-Q101 Standards for High Reliability**

Mechanical Data

- Case: PowerDI®123
- Case Material: Molded Plastic, "Green" Molding Compound. UL Flammability Classification Rating 94V-0
- Moisture Sensitivity: Level 1 per J-STD-020
- Terminal Connections: Cathode Band
- Terminals: Finish – Matte Tin Annealed Over Copper leadframe. Solderable per MIL-STD-202, Method 208
- Marking Information: See Page 2
- Ordering Information: See Page 2
- Weight: 0.01 grams (approximate)



Top View

Maximum Ratings @T_A = 25°C unless otherwise specified

Single phase, half wave, 60Hz, resistive or inductive load.
 For capacitance load, derate current by 20%.

Characteristic	Symbol	Value	Unit
Peak Repetitive Reverse Voltage	V _{RRM}	40	V
Working Peak Reverse Voltage	V _{RWM}		
DC Blocking Voltage	V _R		
RMS Reverse Voltage	V _{R(RMS)}	28	V
Average Forward Current	I _{F(AV)}	2.0	A
Non-Repetitive Peak Forward Surge Current 8.3ms Single Half Sine-Wave Superimposed on Rated Load	I _{FSM}	50	A

Thermal Characteristics

Characteristic	Symbol	Typ	Max	Unit
Power Dissipation (Note 1)	P _D	—	1.67	W
Power Dissipation (Note 2)	P _D	—	556	mW
Thermal Resistance Junction to Ambient (Note 1)	R _{θJA}	60	—	°C/W
Thermal Resistance Junction to Ambient (Note 2)	R _{θJA}	180	—	°C/W
Thermal Resistance Junction to Soldering (Note 3)	R _{θJS}	—	5	°C/W
Operating Temperature Range (See figure 4)	T _J	-55 to +125		°C
Storage Temperature Range	T _{STG}	-55 to +150		°C

Electrical Characteristics @T_A = 25°C unless otherwise specified

Characteristic	Symbol	Min	Typ	Max	Unit	Test Condition
Reverse Breakdown Voltage (Note 5)	V _{(BR)R}	40	—	—	V	I _R = 500μA
Forward Voltage	V _F	—	0.4	0.45	V	I _F = 1.0A
		—	0.45	0.50		I _F = 2.0A
		—	0.50	0.65		I _F = 3.0A
Leakage Current (Note 5)	I _R	—	—	0.1	mA	V _R = 40V
		—	—	10		V _R = 40V, T _J = 85°C
		—	—	0.05		V _R = 20V
		—	—	5		V _R = 20V, T _J = 85°C
Total Capacitance	C _T	—	90	—	pF	V _R = 10V, f = 1.0MHz

- Notes:
1. Part mounted on 50.8mm X 50.8mm GETEK board with 25.4mm X 25.4mm copper pad, 25% anode, 75% cathode.
 2. Part mounted on FR-4 board with 1.8mm X 2.5mm cathode and 1.8mm X 1.2mm anode, 1 oz. copper pads.
 3. Theoretical R_{θJS} calculated from the top center of the die straight down to the PCB cathode tab solder junction.
 4. EU Directive 2002/95/EC (RoHS). All applicable RoHS exemptions applied. Please visit our website at http://www.diodes.com/products/lead_free.html.
 5. Short duration pulse test used to minimize self-heating effect.

PowerDI is a registered trademark of Diodes Incorporated.

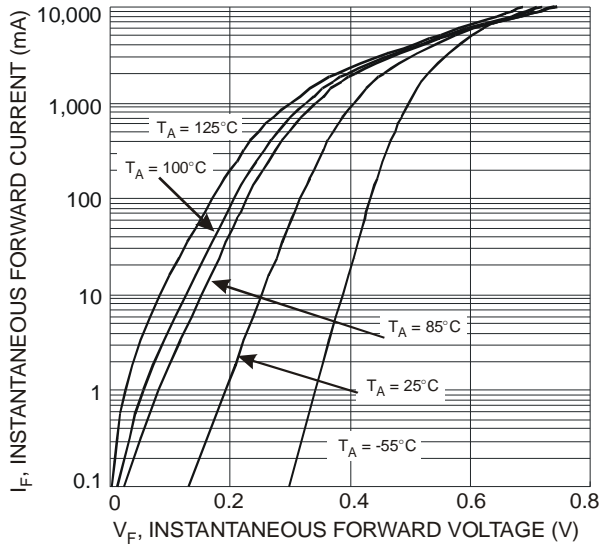

Fig. 1 Typical Forward Characteristics

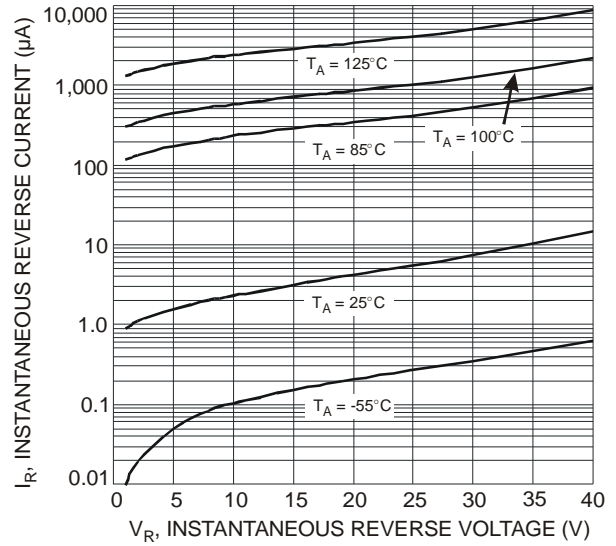

Fig. 2 Typical Reverse Characteristics

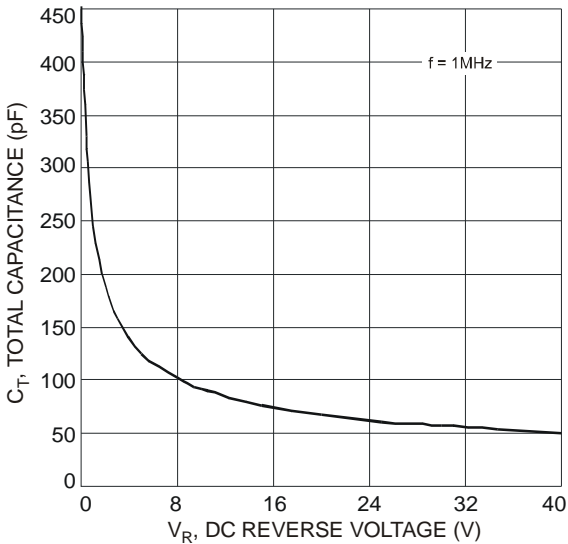

Fig. 3 Total Capacitance vs. Reverse Voltage

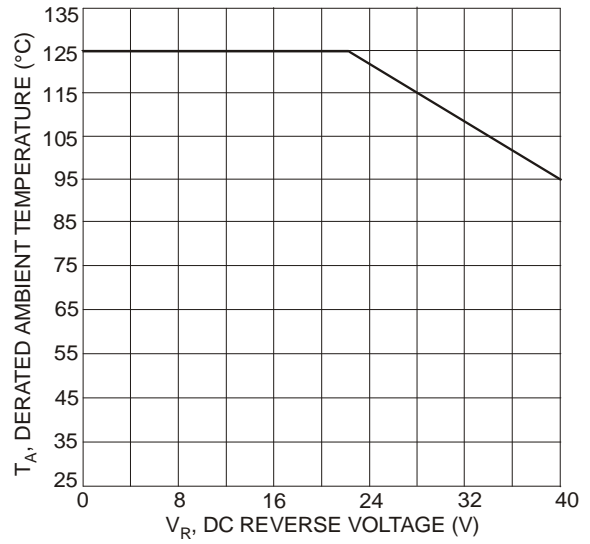

Fig. 4 Operating Temperature Derating

Ordering Information (Note 6)

Part Number	Case	Packaging
DFLS240L-7	PowerDI [®] 123	3000/Tape & Reel

Notes: 6. For packaging details, go to our website at <http://www.diodes.com/datasheets/ap02007.pdf>.

Marking Information

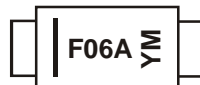

F06A = Product Type Marking Code
 YM = Date Code Marking
 Y = Year (ex: T = 2006)
 M = Month (ex: 9 = September)

Date Code Key

Year	2004	2005	2006	2007	2008	2009	2010	2011	2012			
Code	R	S	T	U	V	W	X	Y	Z			
Month	Jan	Feb	Mar	Apr	May	Jun	Jul	Aug	Sep	Oct	Nov	Dec
Code	1	2	3	4	5	6	7	8	9	O	N	D

PowerDI is a registered trademark of Diodes Incorporated.

Package Outline Dimensions

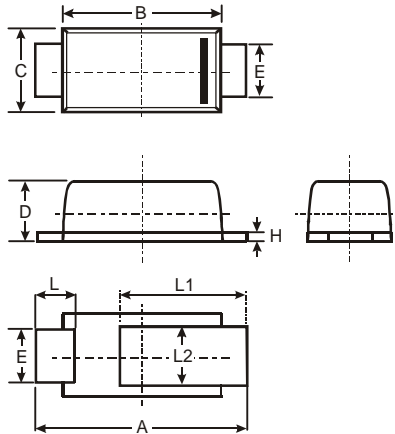

PowerDI [®] 123			
Dim	Min	Max	Typ
A	3.50	3.90	3.70
B	2.60	3.00	2.80
C	1.63	1.93	1.78
D	0.93	1.00	0.98
E	0.85	1.25	1.00
H	0.15	0.25	0.20
L	0.55	0.75	0.65
L1	1.80	2.20	2.00
L2	0.95	1.25	1.10
All Dimensions in mm			

Suggested Pad Layout

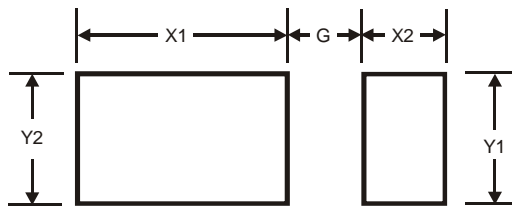

Dimensions	Value (in mm)
G	1.0
X1	2.2
X2	0.9
Y1	1.4
Y2	1.4

IMPORTANT NOTICE

DIODES INCORPORATED MAKES NO WARRANTY OF ANY KIND, EXPRESS OR IMPLIED, WITH REGARDS TO THIS DOCUMENT, INCLUDING, BUT NOT LIMITED TO, THE IMPLIED WARRANTIES OF MERCHANTABILITY AND FITNESS FOR A PARTICULAR PURPOSE (AND THEIR EQUIVALENTS UNDER THE LAWS OF ANY JURISDICTION).

Diodes Incorporated and its subsidiaries reserve the right to make modifications, enhancements, improvements, corrections or other changes without further notice to this document and any product described herein. Diodes Incorporated does not assume any liability arising out of the application or use of this document or any product described herein; neither does Diodes Incorporated convey any license under its patent or trademark rights, nor the rights of others. Any Customer or user of this document or products described herein in such applications shall assume all risks of such use and will agree to hold Diodes Incorporated and all the companies whose products are represented on Diodes Incorporated website, harmless against all damages.

Diodes Incorporated does not warrant or accept any liability whatsoever in respect of any products purchased through unauthorized sales channel. Should Customers purchase or use Diodes Incorporated products for any unintended or unauthorized application, Customers shall indemnify and hold Diodes Incorporated and its representatives harmless against all claims, damages, expenses, and attorney fees arising out of, directly or indirectly, any claim of personal injury or death associated with such unintended or unauthorized application.

Products described herein may be covered by one or more United States, international or foreign patents pending. Product names and markings noted herein may also be covered by one or more United States, international or foreign trademarks.

LIFE SUPPORT

Diodes Incorporated products are specifically not authorized for use as critical components in life support devices or systems without the express written approval of the Chief Executive Officer of Diodes Incorporated. As used herein:

A. Life support devices or systems are devices or systems which:

1. are intended to implant into the body, or
2. support or sustain life and whose failure to perform when properly used in accordance with instructions for use provided in the labeling can be reasonably expected to result in significant injury to the user.

B. A critical component is any component in a life support device or system whose failure to perform can be reasonably expected to cause the failure of the life support device or to affect its safety or effectiveness.

Customers represent that they have all necessary expertise in the safety and regulatory ramifications of their life support devices or systems, and acknowledge and agree that they are solely responsible for all legal, regulatory and safety-related requirements concerning their products and any use of Diodes Incorporated products in such safety-critical, life support devices or systems, notwithstanding any devices- or systems-related information or support that may be provided by Diodes Incorporated. Further, Customers must fully indemnify Diodes Incorporated and its representatives against any damages arising out of the use of Diodes Incorporated products in such safety-critical, life support devices or systems.

Copyright © 2009, Diodes Incorporated

www.diodes.com



LittleDiode supplies new, hard to find or obsolete electronic components and semiconductors all over the world.

With over two million different components listed you are sure to find the part you need.

Feel free to visit us today at our online store:

LittleDiode.com

Looking forward to providing you with the best possible service.