

2-phase half-wave motor predriver

BA6406F

The BA6406F is a 2-phase, half-wave motor predriver suited for fan motors.

●Features

- 1) Lock detection and rotational speed sensing mechanisms are built in.
- 2) Compact 8-pin SOP package reduces the number of external components required.
- 3) Automatic restart when the motor lock is undone.
- 4) Hall inputs have a hysteresis.

●Absolute maximum ratings

Parameter	Symbol	Limits	Unit
Applied voltage	V _{CC}	30	V
Power dissipation	P _d	550*	mW
Operating temperature	T _{opr}	-30~+75	°C
Storage temperature	T _{stg}	-55~+125	°C
Output current	I _{o Max.}	70	mA

* Reduced by 5.5 mW for each increase in T_a of 1°C over 25°C

When mounted on a glass epoxy board (50×50×1.6 mm) .

●Operating power supply voltage (T_a = 25°C)

Parameter	Symbol	Min.	Typ.	Max.	Unit	Conditions
Applied voltage	V _{CC}	4	—	28	V	Operate within the allowable power dissipation for -30 °C < T _a < 75 °C
Input voltage *	V _{BH}	1.0	—	V _{CC} -0.5	V	—

* Input voltage range includes the amplitude of signal.

●Block diagram and application example

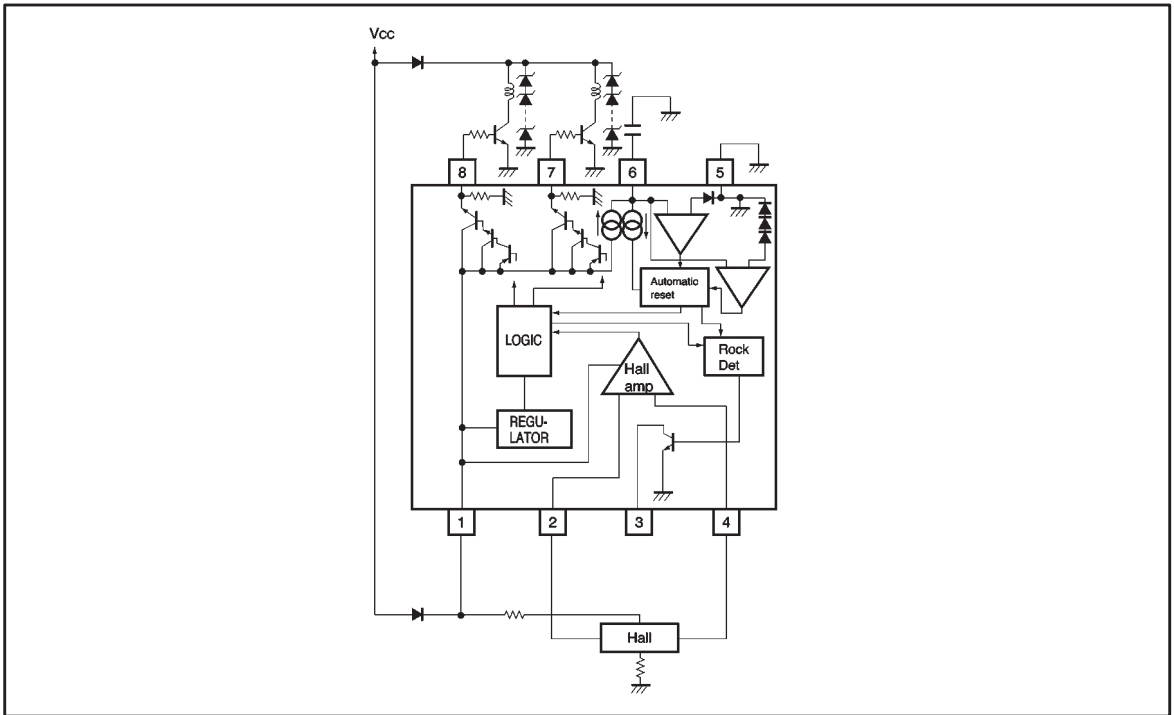

●Electrical characteristics (unless otherwise noted, $T_a = 25^\circ\text{C}$ and $V_{CC} = 12\text{V}$)

Parameter	Symbol	Min.	Typ.	Max.	Unit	Conditions
Supply current	I_{CC}	—	3.2	5.0	mA	When output is OFF
Hall amplifier input hysteresis (+)	V_{hys}^+	3	—	15	mV	Pin2 voltage with respect to pin4 voltage, $V_B = 6\text{V}$
Hall amplifier input hysteresis (-)	V_{hys}^-	-3	—	-15	mV	Pin2 voltage with respect to pin4 voltage, $V_B = 6\text{V}$
Pin6 charge current	I_{6c}	2.0	3.45	5.25	μA	$V_{6pin} = 1.5\text{V}$
Pin6 discharge current	I_{6d}	0.35	0.80	1.45	μA	$V_{6pin} = 1.5\text{V}$
Pin6 charge/discharge ratio	r_{cd}	3	4.5	8	—	I_{6c} / I_{6d}
Pin6 clamp voltage	V_{6CL}	2.2	2.6	3.0	V	—
Pin6 comparator voltage	V_{6CP}	0.4	0.6	0.8	V	—
Pin7 Output high level voltage	V_{7H}	10	10.5	—	V	$I_o = 10\text{mA}$
Pin8 Output high level voltage	V_{8H}	10	10.5	—	V	$I_o = 10\text{mA}$
Pin3 Output low level voltage	V_{3L}	—	—	0.5	V	$I_{3L} = 5.0\text{mA}$
Pin3 current capacity	I_3	8.0	—	—	mA	$V_{3L} = 2.0\text{V}$

● Lock detection

The automatic restart circuit detects a motor lock condition and automatically turns off the output current. When the lock condition is cleared, the IC automatically restarts and allow the motor to run.

In the BA6406F, automatic restart is performed in the following manner. A motor lock condition is detected when

the Hall signal stops switching. The output is ON when pin 6 is being charged, and OFF when pin 6 is being discharged. Pin 3 is ON during normal operation, and OFF when the motor is locked. Pin 3 is an open collector output.

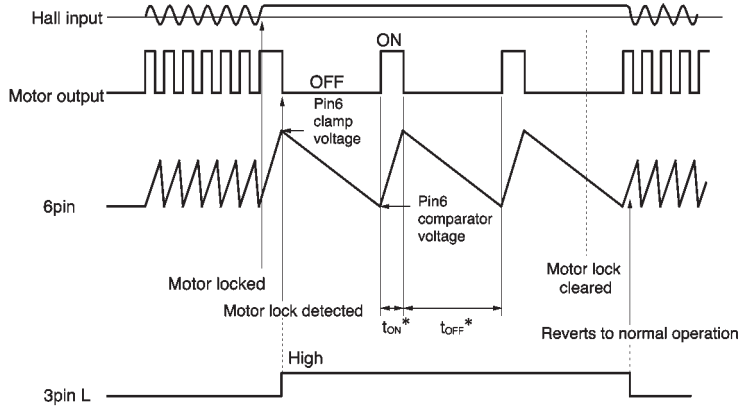

Fig.1

Output ON time (t_{ON}) and OFF time (t_{OFF}) determined by the pin6 capacitor

where

$$t_{ON} = \frac{C \cdot (V_{6CL} - V_{6CP})}{I_{6C}} \text{ (sec)}$$

$$t_{OFF} = \frac{C \cdot (V_{6CL} - V_{6CP})}{I_{6d}} \text{ (sec)}$$

C is the capacitance of the pin-6 external capacitor

V_{6CL} is the pin6 clamp voltage

V_{6CP} is the pin6 comparator voltage

I_{6C} is the pin6 charge current

I_{6d} is the pin6 discharge current

● Operation notes

(1) The lock detection output pin (pin 3) may maintain HIGH level for a few hundred milliseconds when the power is turned on.

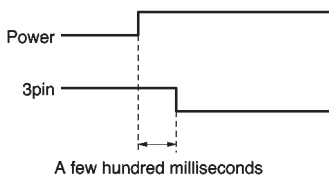

Fig.2

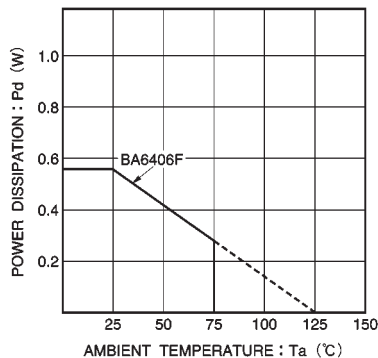

Fig.3

(2) Allowable power dissipation

The allowable power dissipation is plotted against ambient temperature in Fig. 3.

(3) Power dissipation

Power consumed in the IC can be calculated from the following equation:

$$P_C = P_{C1} + P_{C2} + P_{C3}$$

1) P_{C1} is power consumed by the circuit current.

$$P_{C1} = V_{CC} \times I_{CC}$$

2) P_{C2} is the output current consumption.

$$P_{C2} = (V_{CC} - V_{OH}) \times I_o$$

V_{OH} is the HIGH level voltage of pins 7 and 8. Power dissipation can be reduced by raising the hfe-rank of the external output transistor and thereby reducing the I_o value.

3) P_{C3} is power consumed by pin 3.

$$P_{C3} = V_{3L} \times I_3$$

where V_{3L} is the pin-3 LOW level voltage and I_3 is the pin-3 current. Make sure that your application does not exceed the allowable power dissipation of the IC.

● Electrical characteristic curves

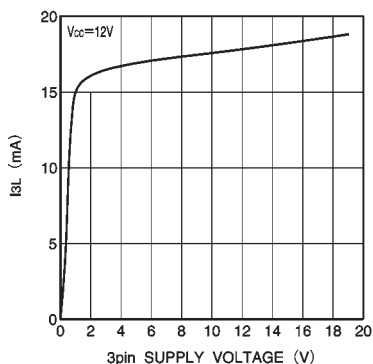

Fig.4 Current capacity vs. supply voltage for pin 3

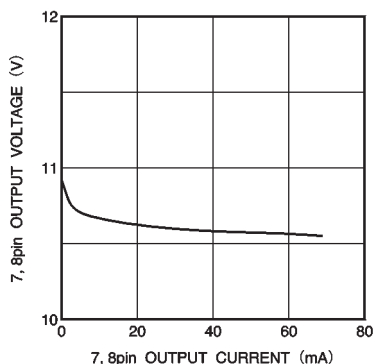
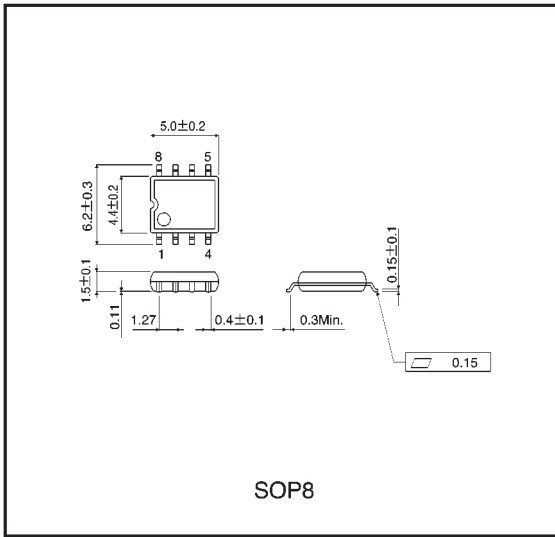

Fig.5 Output voltage vs. output current for pins 7 and 8

●External dimensions (Units: mm)



This datasheet has been downloaded from:

www.DatasheetCatalog.com

Datasheets for electronic components.



LittleDiode supplies new, hard to find or obsolete electronic components and semiconductors all over the world.

With over two million different components listed you are sure to find the part you need.

Feel free to visit us today at our online store:

LittleDiode.com

Looking forward to providing you with the best possible service.