

**RADIATION HARDENED  
 POWER MOSFET  
 THRU-HOLE (TO-254AA)**

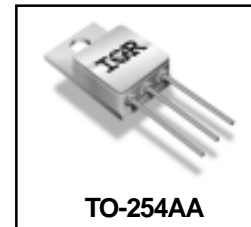
**IRHM7250  
 JANSR2N7269  
 200V, N-CHANNEL**

REF: MIL-PRF-19500/603

**RAD Hard™ HEXFET® TECHNOLOGY**

**Product Summary**

Part Number	Radiation Level	RDS(on)	Id	QPL Part Number
IRHM7250	100K Rads (Si)	0.10Ω	26A	JANSR2N7269
IRHM3250	300K Rads (Si)	0.10Ω	26A	JANSF2N7269
IRHM4250	600K Rads (Si)	0.10Ω	26A	JANSG2N7269
IRHM8250	1000K Rads (Si)	0.10Ω	26A	JANSH2N7269



International Rectifier's RADHard HEXFET® technology provides high performance power MOSFETs for space applications. This technology has over a decade of proven performance and reliability in satellite applications. These devices have been characterized for both Total Dose and Single Event Effects (SEE). The combination of low Rds(on) and low gate charge reduces the power losses in switching applications such as DC to DC converters and motor control. These devices retain all of the well established advantages of MOSFETs such as voltage control, fast switching, ease of paralleling and temperature stability of electrical parameters.

**Features:**

- Single Event Effect (SEE) Hardened
- Low RDS(on)
- Low Total Gate Charge
- Proton Tolerant
- Simple Drive Requirements
- Ease of Paralleling
- Hermetically Sealed
- Ceramic Eyelets
- Light Weight

**Absolute Maximum Ratings**

**Pre-Irradiation**

	Parameter		Units
Id @ VGS = 12V, TC = 25°C	Continuous Drain Current	26	A
Id @ VGS = 12V, TC = 100°C	Continuous Drain Current	16	
IdM	Pulsed Drain Current ①	104	
PD @ TC = 25°C	Max. Power Dissipation	150	W
	Linear Derating Factor	1.2	W/°C
VGS	Gate-to-Source Voltage	±20	V
EAS	Single Pulse Avalanche Energy ②	500	mJ
IAR	Avalanche Current ①	26	A
EAR	Repetitive Avalanche Energy ①	15	mJ
dv/dt	Peak Diode Recovery dv/dt ③	5.0	V/ns
TJ	Operating Junction	-55 to 150	°C
TSTG	Storage Temperature Range		
	Lead Temperature	300 (0.063 in. (1.6mm) from case for 10s)	
	Weight	9.3 (Typical)	g

For footnotes refer to the last page

**Electrical Characteristics @ T<sub>j</sub> = 25°C (Unless Otherwise Specified)**

	Parameter	Min	Typ	Max	Units	Test Conditions
BV <sub>DSS</sub>	Drain-to-Source Breakdown Voltage	200	—	—	V	V <sub>GS</sub> = 0 V, I <sub>D</sub> = 1.0mA
ΔBV <sub>DSS</sub> /ΔT <sub>J</sub>	Temperature Coefficient of Breakdown Voltage	—	0.27	—	V/°C	Reference to 25°C, I <sub>D</sub> = 1.0mA
R <sub>DS(on)</sub>	Static Drain-to-Source On-State Resistance	—	—	0.10	Ω	V <sub>GS</sub> = 12V, I <sub>D</sub> = 16A
		—	—	0.11		V <sub>GS</sub> = 12V, I <sub>D</sub> = 26A ④
V <sub>GS(th)</sub>	Gate Threshold Voltage	2.0	—	4.0	V	V <sub>DS</sub> = V <sub>GS</sub> , I <sub>D</sub> = 1.0mA
g <sub>fs</sub>	Forward Transconductance	8.0	—	—	S (τ)	V <sub>DS</sub> > 15V, I <sub>DS</sub> = 16A ④
I <sub>DSS</sub>	Zero Gate Voltage Drain Current	—	—	25	μA	V <sub>DS</sub> = 160V, V <sub>GS</sub> = 0V
		—	—	250		V <sub>DS</sub> = 160V V <sub>GS</sub> = 0V, T <sub>J</sub> = 125°C
I <sub>GSS</sub>	Gate-to-Source Leakage Forward	—	—	100	nA	V <sub>GS</sub> = 20V
I <sub>GSS</sub>	Gate-to-Source Leakage Reverse	—	—	-100		V <sub>GS</sub> = -20V
Q <sub>g</sub>	Total Gate Charge	—	—	170	nC	V <sub>GS</sub> = 12V, I <sub>D</sub> = 26A
Q <sub>gs</sub>	Gate-to-Source Charge	—	—	30		V <sub>DS</sub> = 100V
Q <sub>gd</sub>	Gate-to-Drain ('Miller') Charge	—	—	60		
t <sub>d(on)</sub>	Turn-On Delay Time	—	—	33	ns	V <sub>DD</sub> = 100V, I <sub>D</sub> = 26A, R <sub>G</sub> = 2.35Ω
t <sub>r</sub>	Rise Time	—	—	140		
t <sub>d(off)</sub>	Turn-Off Delay Time	—	—	140		
t <sub>f</sub>	Fall Time	—	—	140		
L <sub>S</sub> + L <sub>D</sub>	Total Inductance	—	6.8	—	nH	Measured from drain lead (6mm/0.25in. from package) to source lead (6mm/0.25in. from package)
C <sub>iss</sub>	Input Capacitance	—	4700	—	pF	V <sub>GS</sub> = 0V, V <sub>DS</sub> = 25V f = 1.0MHz
C <sub>oss</sub>	Output Capacitance	—	850	—		
C <sub>rss</sub>	Reverse Transfer Capacitance	—	210	—		

**Source-Drain Diode Ratings and Characteristics**

	Parameter	Min	Typ	Max	Units	Test Conditions
I <sub>S</sub>	Continuous Source Current (Body Diode)	—	—	26	A	
I <sub>SM</sub>	Pulse Source Current (Body Diode) ①	—	—	104		
V <sub>SD</sub>	Diode Forward Voltage	—	—	1.4	V	T <sub>j</sub> = 25°C, I <sub>S</sub> = 26A, V <sub>GS</sub> = 0V ④
t <sub>rr</sub>	Reverse Recovery Time	—	—	820	nS	T <sub>j</sub> = 25°C, I <sub>F</sub> = 26A, di/dt ≥ 100A/μs
Q <sub>RR</sub>	Reverse Recovery Charge	—	—	12	μC	V <sub>DD</sub> ≤ 25V ④
t <sub>on</sub>	Forward Turn-On Time	Intrinsic turn-on time is negligible. Turn-on speed is substantially controlled by L <sub>S</sub> + L <sub>D</sub> .				

**Thermal Resistance**

	Parameter	Min	Typ	Max	Units	Test Conditions
R <sub>thJC</sub>	Junction-to-Case	—	—	0.83	°C/W	Typical socket mount
R <sub>thCS</sub>	Case-to-sink	—	0.21	—		
R <sub>thJA</sub>	Junction-to-Ambient	—	—	48		

Note: Corresponding Spice and Saber models are available on the G&S Website.

For footnotes refer to the last page

## Radiation Characteristics

## IRHM7250, JANSR2N7269

International Rectifier Radiation Hardened MOSFETs are tested to verify their radiation hardness capability. The hardness assurance program at International Rectifier is comprised of two radiation environments. Every manufacturing lot is tested for total ionizing dose (per notes 5 and 6) using the TO-3 package. Both pre- and post-irradiation performance are tested and specified using the same drive circuitry and test conditions in order to provide a direct comparison.

**Table 1. Electrical Characteristics @ Tj = 25°C, Post Total Dose Irradiation ⑤⑥**

	Parameter	100K Rads(Si) <sup>1</sup>		600 to 1000K Rads (Si) <sup>2</sup>		Units	Test Conditions
		Min	Max	Min	Max		
BV <sub>DSS</sub>	Drain-to-Source Breakdown Voltage	200	—	200	—	V	V <sub>GS</sub> = 0V, I <sub>D</sub> = 1.0mA
V <sub>GS(th)</sub>	Gate Threshold Voltage ④	2.0	4.0	1.25	4.5		V <sub>GS</sub> = V <sub>DS</sub> , I <sub>D</sub> = 1.0mA
I <sub>GSS</sub>	Gate-to-Source Leakage Forward	—	100	—	100	nA	V <sub>GS</sub> = 20V
I <sub>GSS</sub>	Gate-to-Source Leakage Reverse	—	-100	—	-100		V <sub>GS</sub> = -20V
I <sub>DSS</sub>	Zero Gate Voltage Drain Current	—	25	—	50	μA	V <sub>DS</sub> =160V, V <sub>GS</sub> =0V
R <sub>DS(on)</sub>	Static Drain-to-Source ④ On-State Resistance (TO-3)	—	0.094	—	0.149	Ω	V <sub>GS</sub> = 12V, I <sub>D</sub> = 16A
R <sub>DS(on)</sub>	Static Drain-to-Source ④ On-State Resistance (TO-254AA)	—	0.10	—	0.155	Ω	V <sub>GS</sub> = 12V, I <sub>D</sub> = 16A
V <sub>SD</sub>	Diode Forward Voltage ④	—	1.4	—	1.4	V	V <sub>GS</sub> = 0V, I <sub>S</sub> = 26A

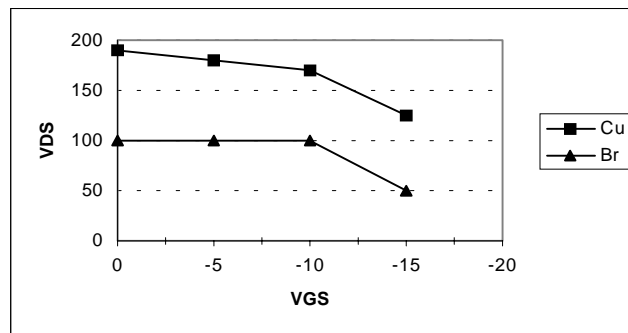
1. Part number IRHM7250 (JANSR2N7269)

2. Part numbers IRHM3250 (JANSF2N7269), IRHM4250 (JANSF2N7269) and IRHM8250 (JANSF2N7269)

International Rectifier radiation hardened MOSFETs have been characterized in heavy ion environment for Single Event Effects (SEE). Single Event Effects characterization is illustrated in Fig. a and Table 2.

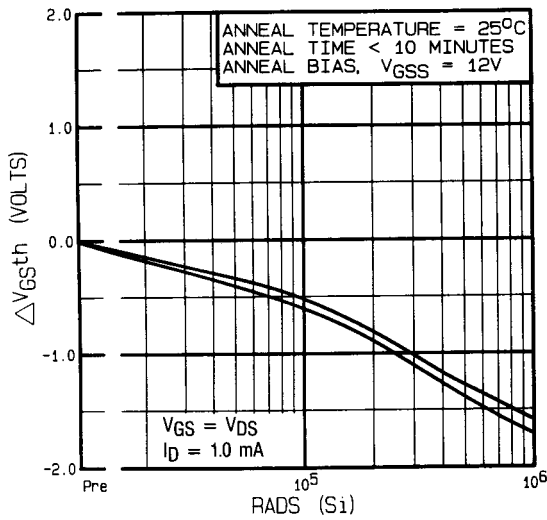
**Table 2. Single Event Effect Safe Operating Area**

Ion	LET MeV/(mg/cm <sup>2</sup> )	Energy (MeV)	Range (μm)	V <sub>DS</sub> (V)				
				@V <sub>GS</sub> =0V	@V <sub>GS</sub> =-5V	@V <sub>GS</sub> =-10V	@V <sub>GS</sub> =-15V	@V <sub>GS</sub> =-20V
Cu	28	285	43	190	180	170	125	—
Br	36.8	305	39	100	100	100	50	—

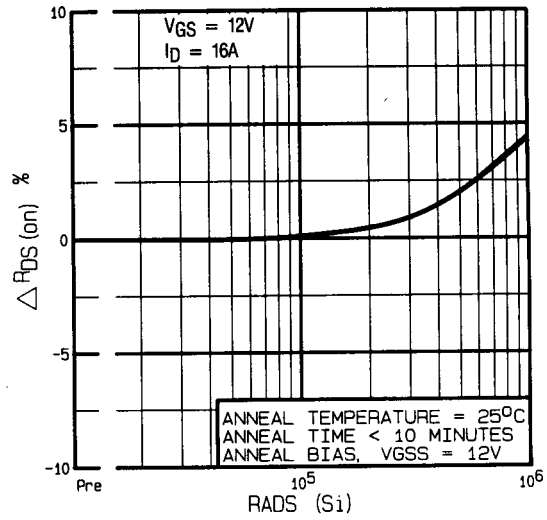


**Fig a. Single Event Effect, Safe Operating Area**

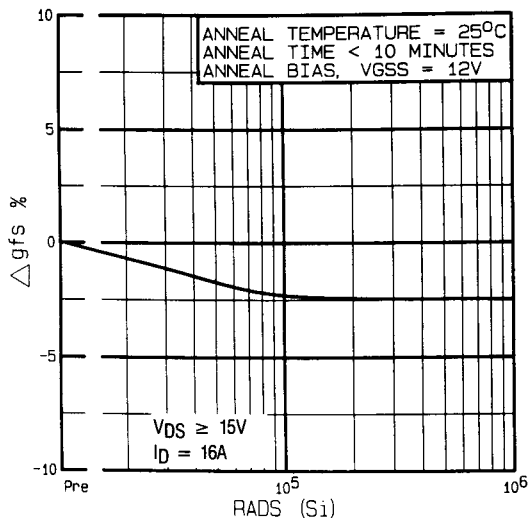
For footnotes refer to the last page



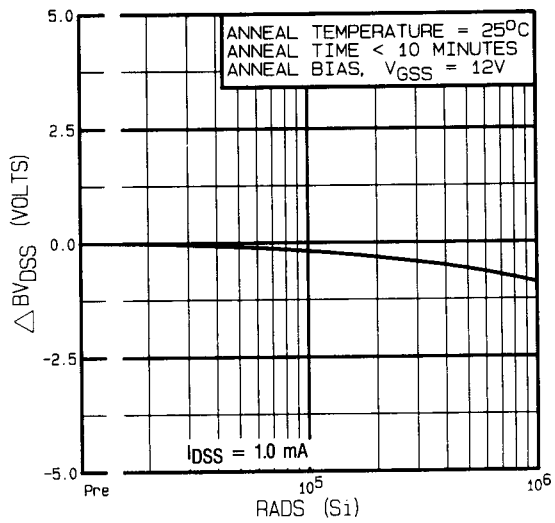
**Fig 1.** Typical Response of Gate Threshold Voltage Vs. Total Dose Exposure



**Fig 2.** Typical Response of On-State Resistance Vs. Total Dose Exposure



**Fig 3.** Typical Response of Transconductance Vs. Total Dose Exposure



**Fig 4.** Typical Response of Drain to Source Breakdown Vs. Total Dose Exposure

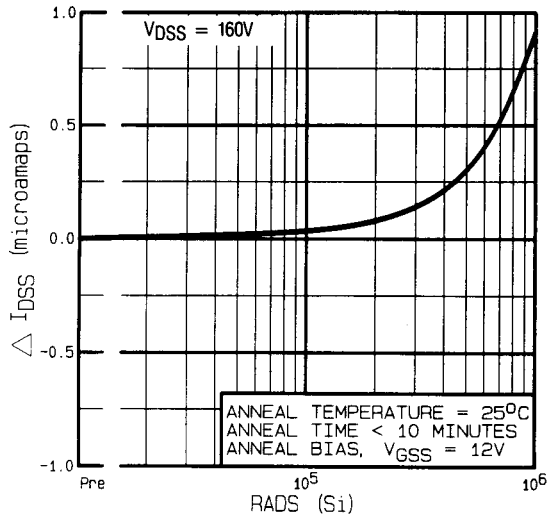


Fig 5. Typical Zero Gate Voltage Drain Current Vs. Total Dose Exposure

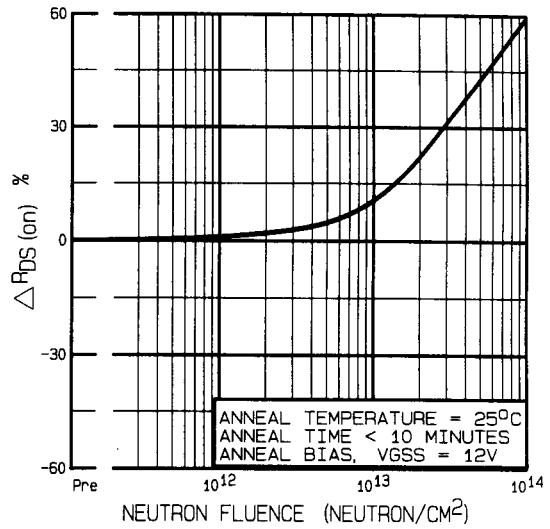


Fig 6. Typical On-State Resistance Vs. Neutron Fluence Level

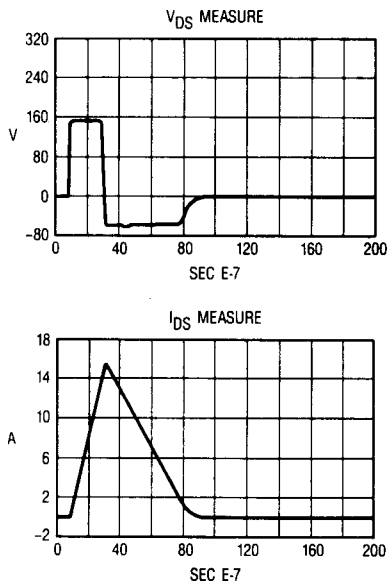


Fig 7. Typical Transient Response of Rad Hard HEXFET During  $1 \times 10^{12}$  Rad (Si)/Sec Exposure

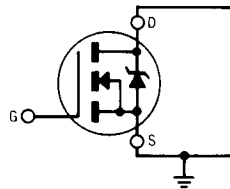


Fig 8a. Gate Stress of  $V_{GSS}$  Equals 12 Volts During Radiation

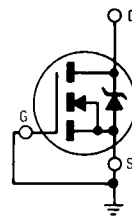


Fig 8b.  $V_{DSS}$  Stress Equals 80% of  $B_{V_{DSS}}$  During Radiation

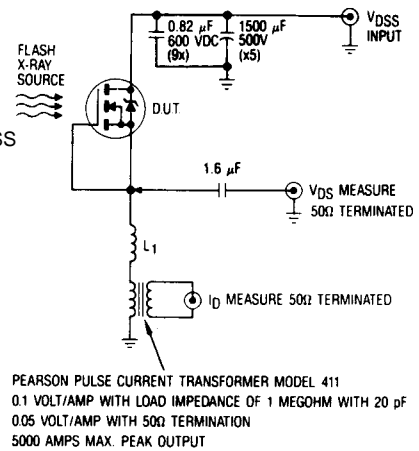


Fig 9. High Dose Rate (Gamma Dot) Test Circuit

Note: Bias Conditions during radiation:  $V_{GS} = 12\text{ Vdc}$ ,  $V_{DS} = 0\text{ Vdc}$

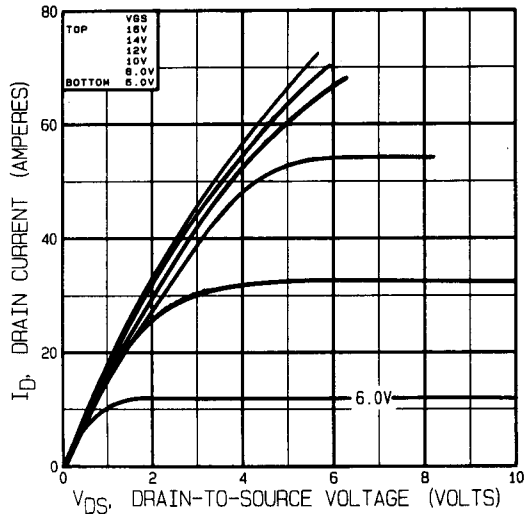


Fig 10. Typical Output Characteristics Pre-Irradiation

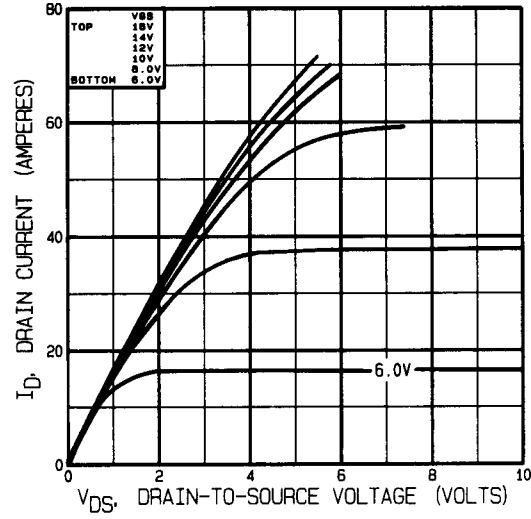


Fig 11. Typical Output Characteristics Post-Irradiation 100K Rads (Si)

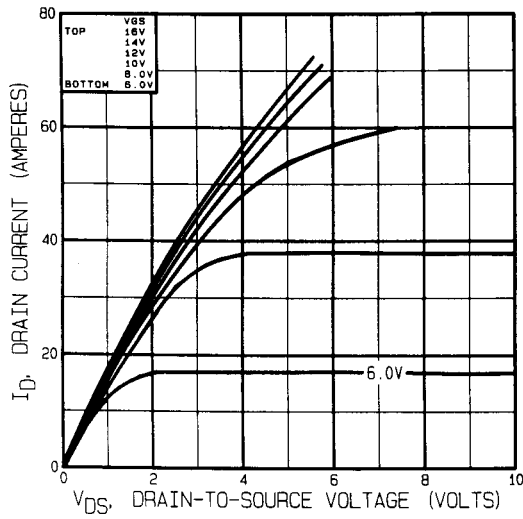


Fig 12. Typical Output Characteristics Post-Irradiation 300K Rads (Si)

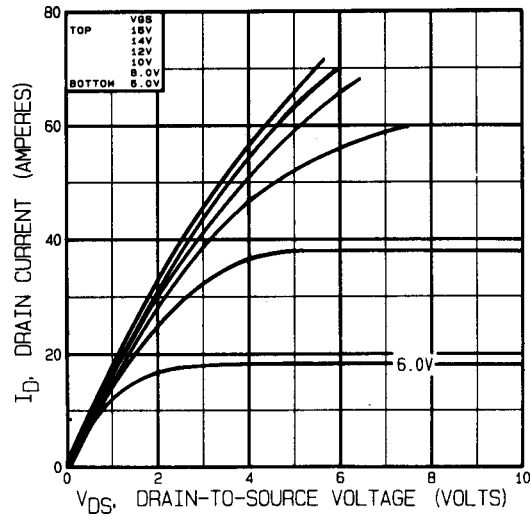
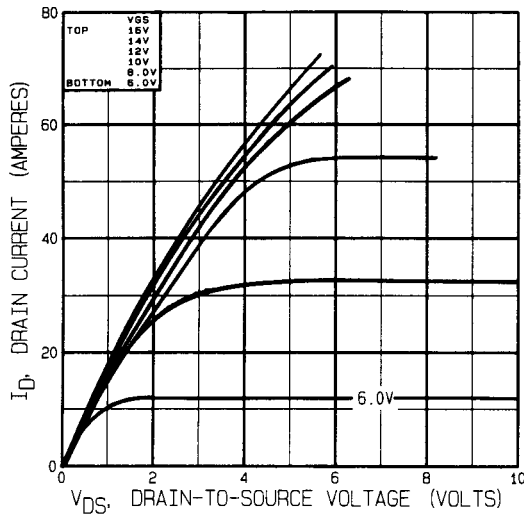


Fig 13. Typical Output Characteristics Post-Irradiation 1 Mega Rads (Si)

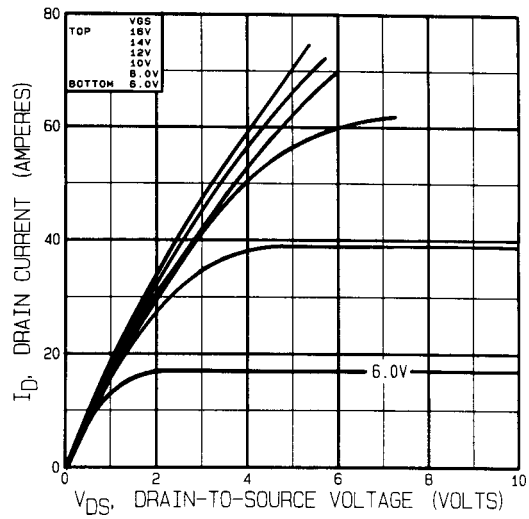
## Radiation Characteristics

IRHM7250, JANSR2N7269

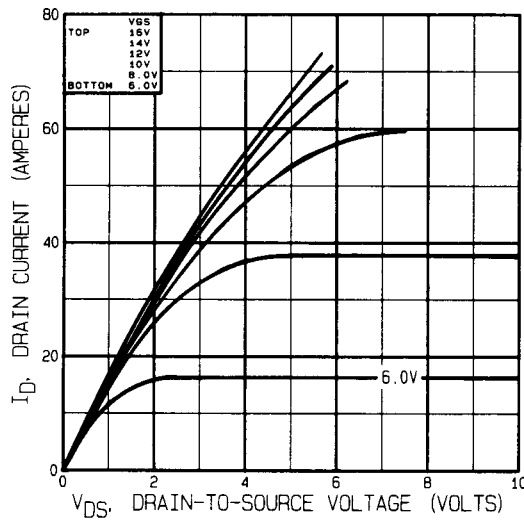
Note: Bias Conditions during radiation:  $V_{GS} = 0$  Vdc,  $V_{DS} = 160$  Vdc



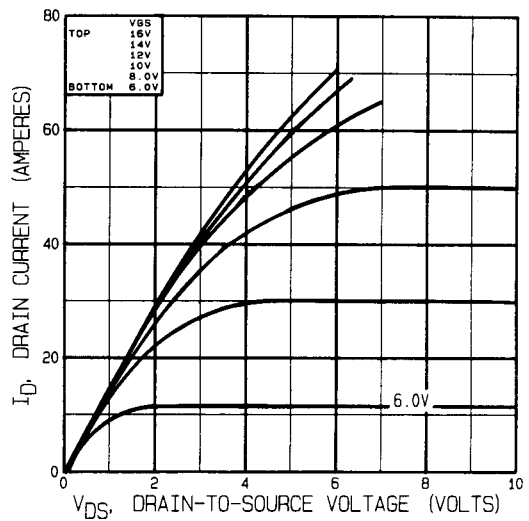
**Fig 14.** Typical Output Characteristics Pre-Irradiation



**Fig 15.** Typical Output Characteristics Post-Irradiation 100K Rads (Si)



**Fig 16.** Typical Output Characteristics Post-Irradiation 300K Rads (Si)



**Fig 17.** Typical Output Characteristics Post-Irradiation 1 Mega Rads (Si)

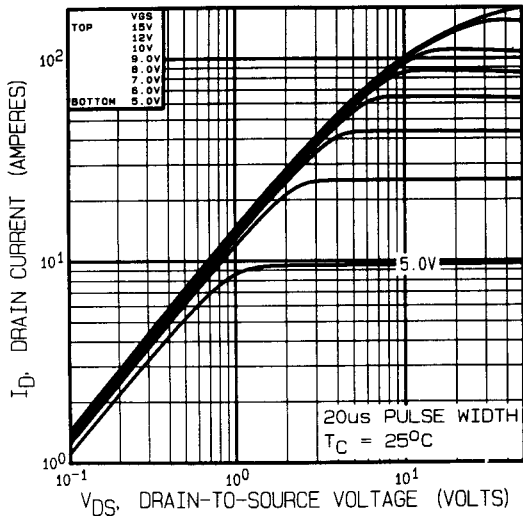


Fig 18. Typical Output Characteristics

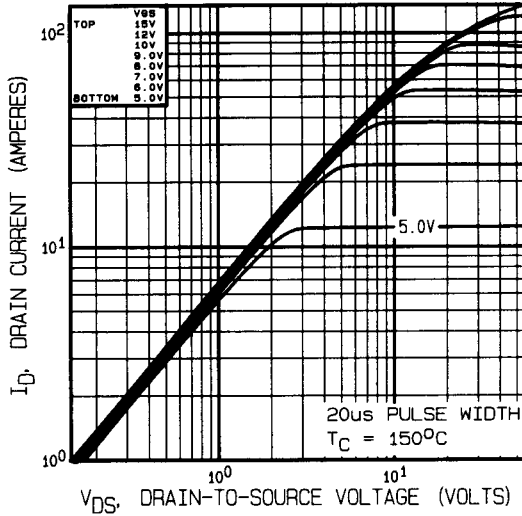


Fig 19. Typical Output Characteristics

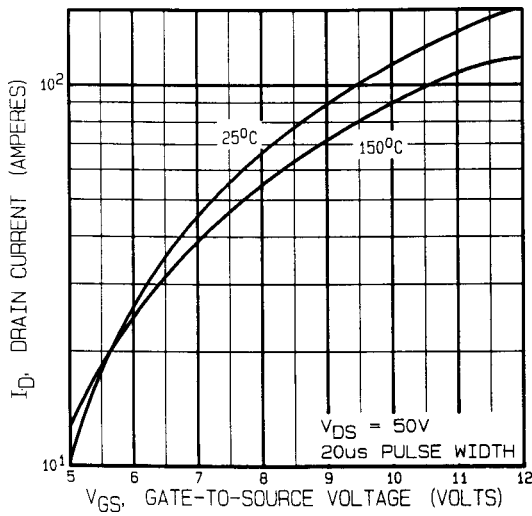


Fig 20. Typical Transfer Characteristics

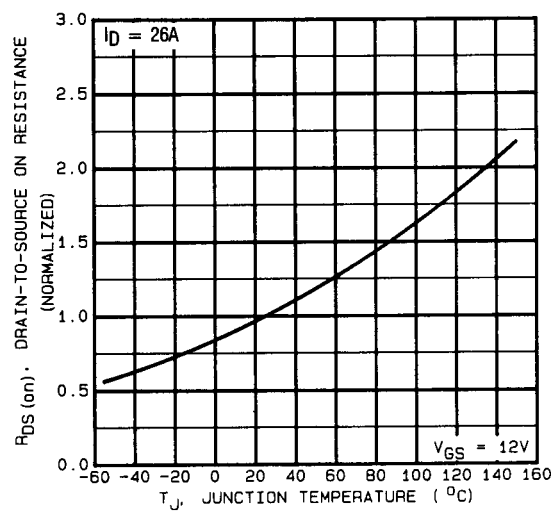


Fig 21. Normalized On-Resistance Vs. Temperature

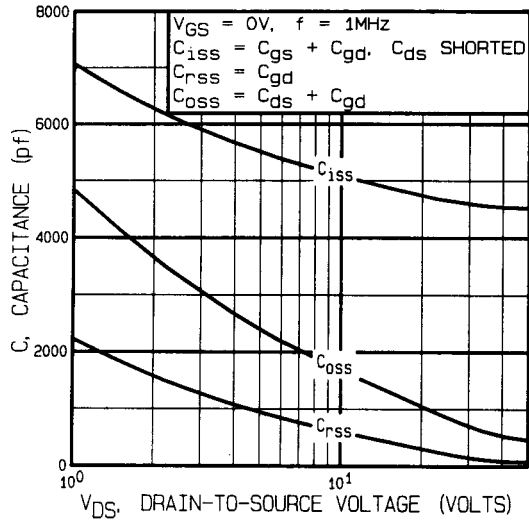


Fig 22. Typical Capacitance Vs. Drain-to-Source Voltage

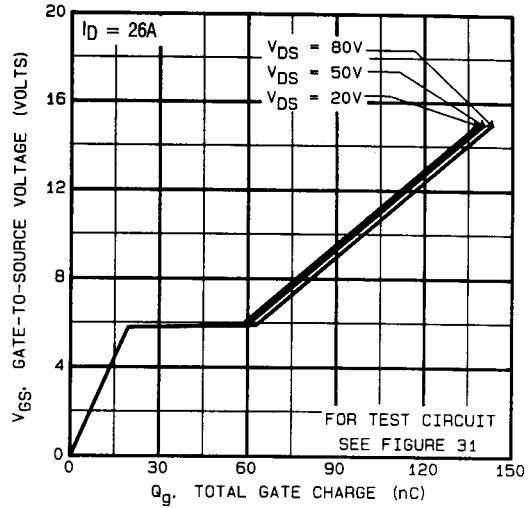


Fig 23. Typical Gate Charge Vs. Gate-to-Source Voltage

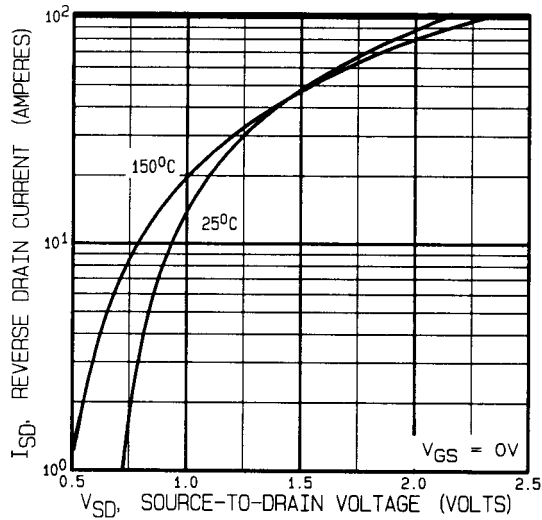


Fig 24. Typical Source-Drain Diode Forward Voltage

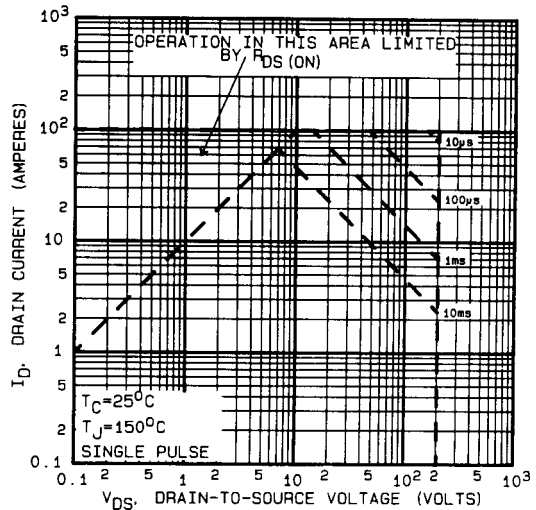


Fig 25. Maximum Safe Operating Area

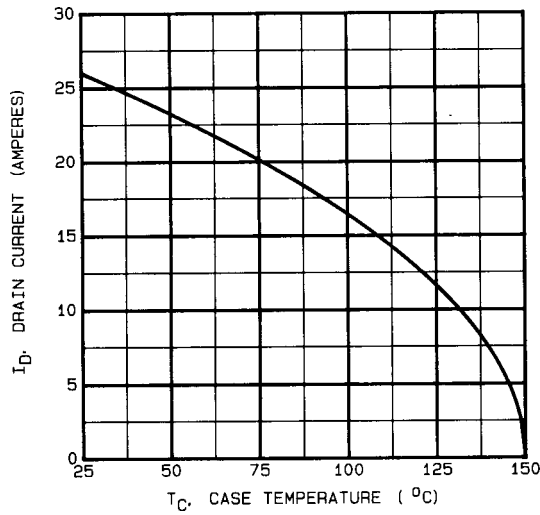


Fig 26. Maximum Drain Current Vs. Case Temperature

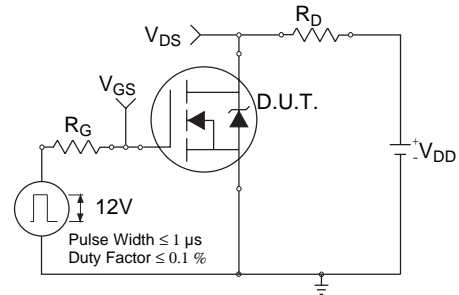


Fig 26a. Switching Time Test Circuit

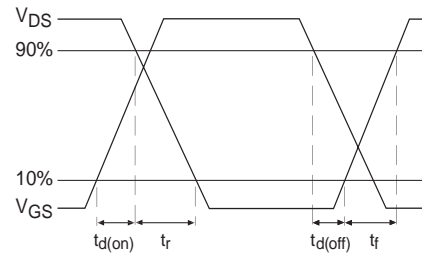


Fig 26b. Switching Time Waveforms

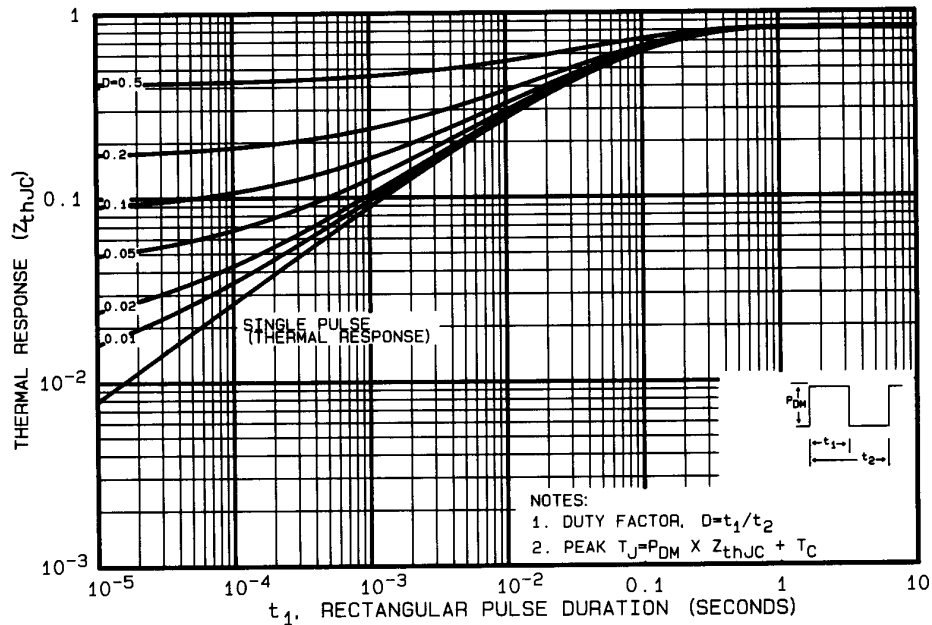


Fig 27. Maximum Effective Transient Thermal Impedance, Junction-to-Case

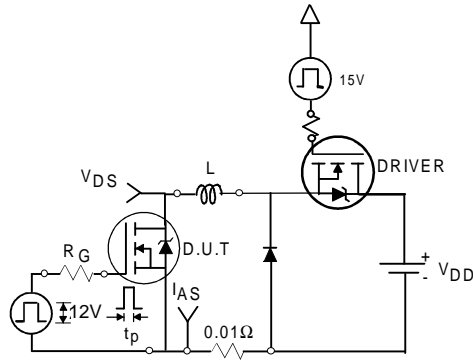


Fig 28a. Unclamped Inductive Test Circuit

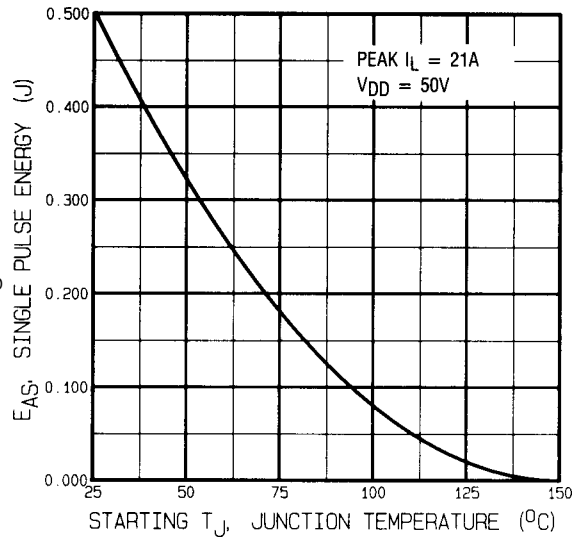


Fig 28c. Maximum Avalanche Energy Vs. Drain Current

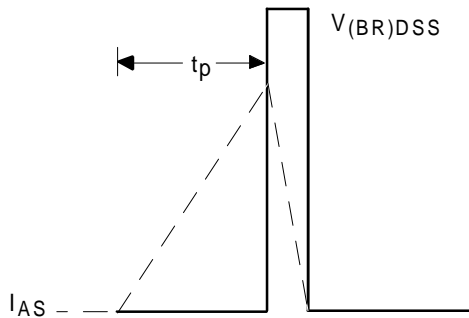


Fig 28b. Unclamped Inductive Waveforms

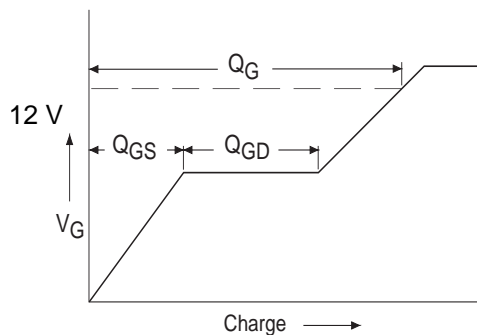


Fig 29a. Basic Gate Charge Waveform

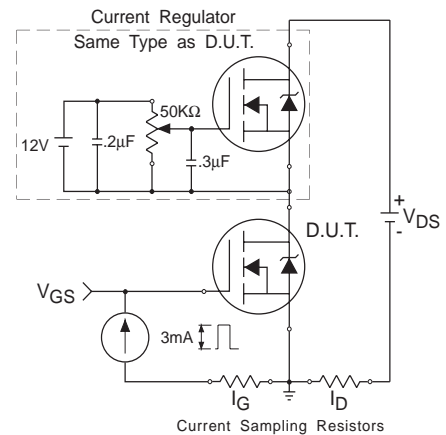
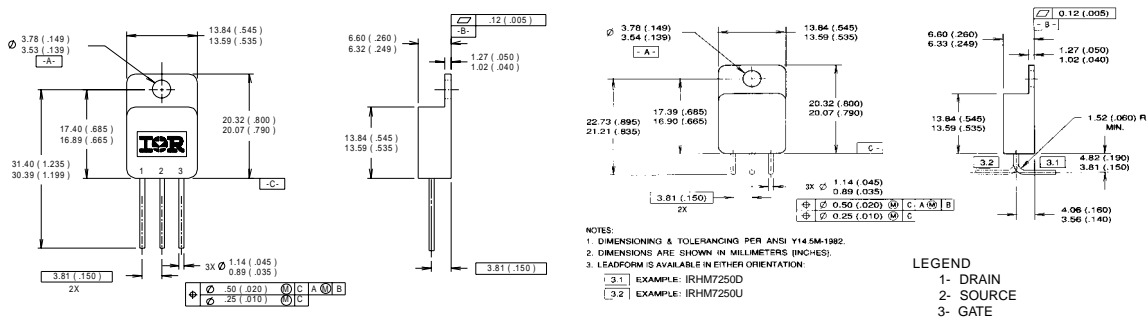


Fig 29b. Gate Charge Test Circuit

**Foot Notes:**

- ① Repetitive Rating; Pulse width limited by maximum junction temperature.
- ②  $V_{DD} = 25V$ , starting  $T_J = 25^\circ C$ ,  $L = 1.5mH$   
Peak  $I_L = 26A$ ,  $V_{GS} = 12V$
- ③  $I_{SD} \leq 26A$ ,  $di/dt \leq 190A/\mu s$ ,  
 $V_{DD} \leq 200V$ ,  $T_J \leq 150^\circ C$
- ④ Pulse width  $\leq 300 \mu s$ ; Duty Cycle  $\leq 2\%$
- ⑤ **Total Dose Irradiation with  $V_{GS}$  Bias.**  
12 volt  $V_{GS}$  applied and  $V_{DS} = 0$  during irradiation per MIL-STD-750, method 1019, condition A.
- ⑥ **Total Dose Irradiation with  $V_{DS}$  Bias.**  
160 volt  $V_{DS}$  applied and  $V_{GS} = 0$  during irradiation per MIL-STD-750, method 1019, condition A.

**Case Outline and Dimensions — TO-254AA**



**CAUTION**

**BERYLLIA WARNING PER MIL-PRF-19500**

Packages containing beryllia shall not be ground, sandblasted, machined or have other operations performed on them which will produce beryllia or beryllium dust. Furthermore, beryllium oxide packages shall not be placed in acids that will produce fumes containing beryllium.



**IR WORLD HEADQUARTERS:** 233 Kansas St., El Segundo, California 90245, USA Tel: (310) 252-7105  
**IR EUROPEAN REGIONAL CENTRE:** 439/445 Godstone Rd, Whyteleafe, Surrey CR3 OBL, UK Tel: ++ 44 (0)20 8645 8000  
**IR CANADA:** 15 Lincoln Court, Brampton, Ontario L6T3Z2, Tel: (905) 453 2200  
**IR GERMANY:** Saalburgstrasse 157, 61350 Bad Homburg Tel: ++ 49 (0) 6172 96590  
**IR ITALY:** Via Liguria 49, 10071 Borgaro, Torino Tel: ++ 39 011 451 0111  
**IR JAPAN:** K&H Bldg., 2F, 30-4 Nishi-Ikebukuro 3-Chome, Toshima-Ku, Tokyo 171 Tel: 81 (0)3 3983 0086  
**IR SOUTHEAST ASIA:** 1 Kim Seng Promenade, Great World City West Tower, 13-11, Singapore 237994 Tel: ++ 65 (0)838 4630  
**IR TAIWAN:** 16 Fl. Suite D. 207, Sec. 2, Tun Haw South Road, Taipei, 10673 Tel: 886-(0)2 2377 9936  
*Data and specifications subject to change without notice. 10/00*



LittleDiode supplies new, hard to find or obsolete electronic components and semiconductors all over the world.

With over two million different components listed you are sure to find the part you need.

Feel free to visit us today at our online store:

[LittleDiode.com](http://LittleDiode.com)

Looking forward to providing you with the best possible service.