

9097250 TOSHIBA (DISCRETE/OPTO)

56C 07616 DT-33-13

SILICON NPN TRIPLE DIFFUSED TYPE

**2SC2914**

SWITCHING REGULATOR AND HIGH VOLTAGE  
SWITCHING APPLICATIONS,  
HIGH SPEED DC-DC CONVERTER APPLICATIONS.

## FEATURES:

- Excellent Switching Times  
:  $t_r=1.0\mu s$ (Max.),  $t_f=1.0\mu s$ (Max.) at  $I_C=7A$
- High Collector Breakdown Voltage :  $V_{CEO}=400V$

## MAXIMUM RATINGS (Ta=25°C)

CHARACTERISTIC	SYMBOL	RATING	UNIT
Collector-Base Voltage	$V_{CBO}$	500	V
Collector-Emitter Voltage	$V_{CEO}$	400	V
Emitter-Base Voltage	$V_{EBO}$	7	V
Collector Current	$I_C$	10	A
Base Current	$I_B$	3	A
Collector Power Dissipation (Tc=25°C)	$P_C$	120	W
Junction Temperature	$T_j$	150	°C
Storage Temperature Range	$T_{stg}$	-65 ~ 150	°C

## INDUSTRIAL APPLICATIONS

Unit in mm

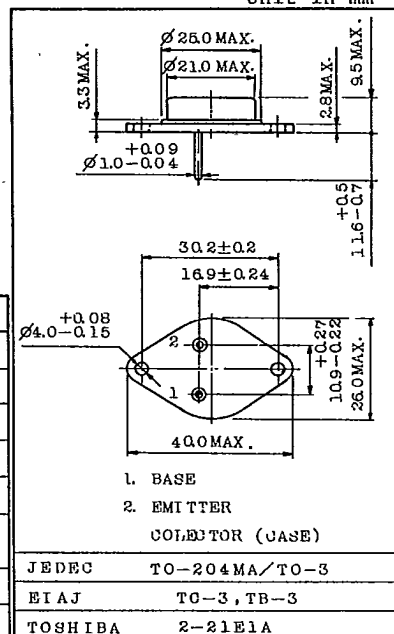

- BASE
  - EMITTER
- COLLECTOR (CASE)

JEDEC TO-204MA/TO-3

EIAJ TC-3, TB-3

TOSHIBA 2-21E1A

Mounting kit No. AC73

Weight : 15.3g

## ELECTRICAL CHARACTERISTICS (Ta=25°C)

CHARACTERISTIC	SYMBOL	TEST CONDITION	MIN.	TYP.	MAX.	UNIT
Collector Cut-off Current	$I_{CBO}$	$V_{CB}=400V, I_E=0$	-	-	100	$\mu A$
Emitter Cut-off Current	$I_{EBO}$	$V_{EB}=7V, I_C=0$	-	-	1	mA
Collector-Base Breakdown Voltage	$V_{(BR)CBO}$	$I_C=1mA, I_E=0$	500	-	-	V
Collector-Emitter Breakdown Voltage	$V_{(BR)CEO}$	$I_C=10mA, I_B=0$	400	-	-	V
DC Current Gain	$h_{FE}$	$V_{CE}=5V, I_C=5A$	12	-	-	
		$V_{CE}=5V, I_C=10A$	8	-	-	
Collector-Emitter Saturation Voltage	$V_{CE(sat)}$	$I_C=10A, I_B=2A$	-	-	1.0	V
Base-Emitter Saturation Voltage	$V_{BE(sat)}$	$I_C=10A, I_B=2A$	-	-	2.0	V
Switching Time	Rise Time	$t_r$	-	-	1.0	$\mu s$
	Storage Time	$t_{stg}$	-	-	2.5	
	Fall Time	$t_f$	-	-	1.0	

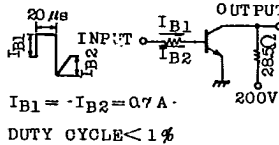

TOSHIBA CORPORATION

**2SC2914**

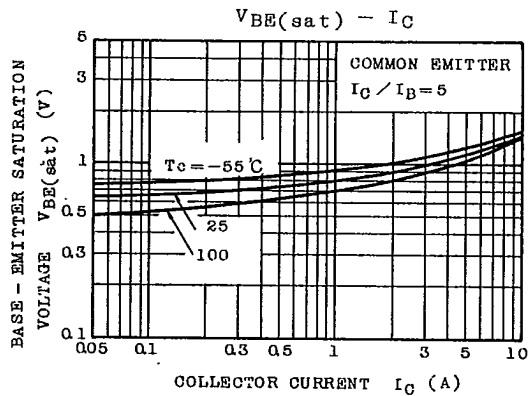
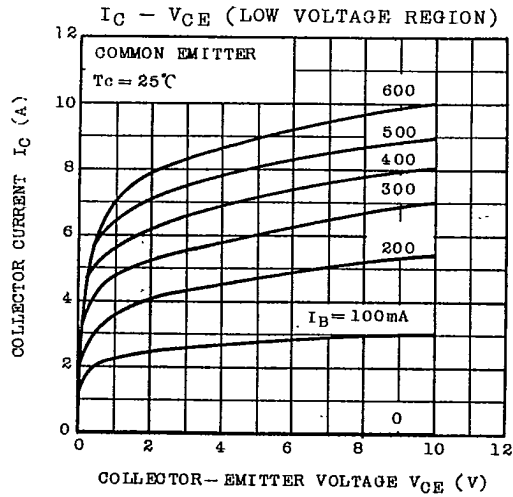
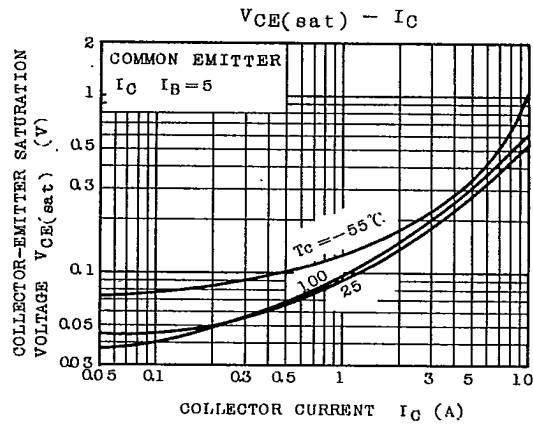
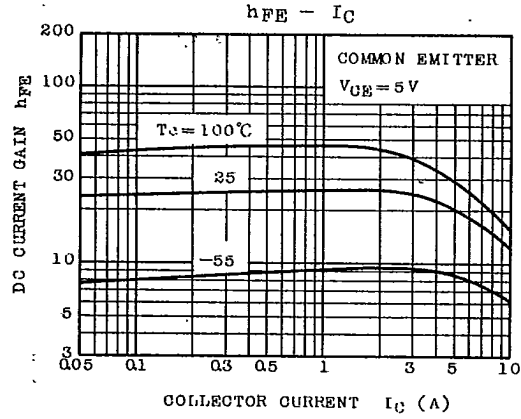
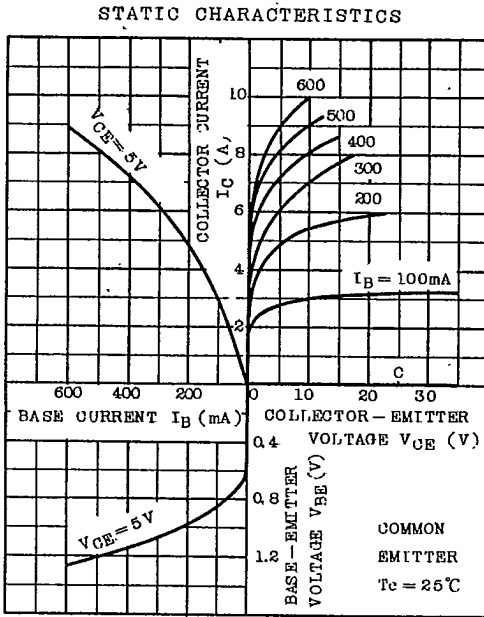

TOSHIBA CORPORATION

2SC2914

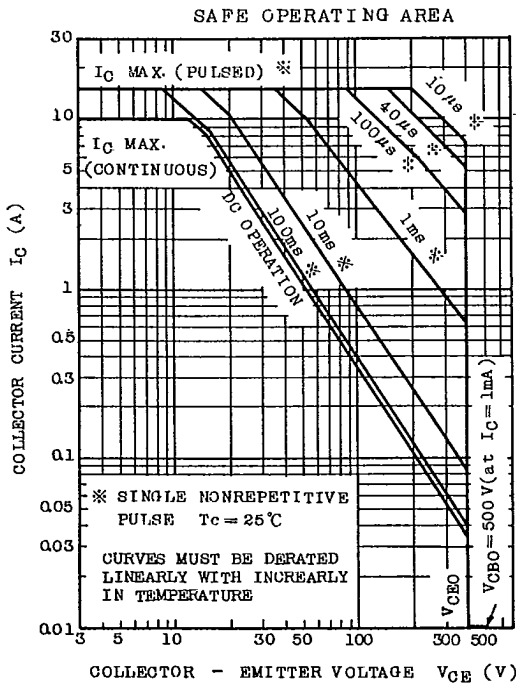
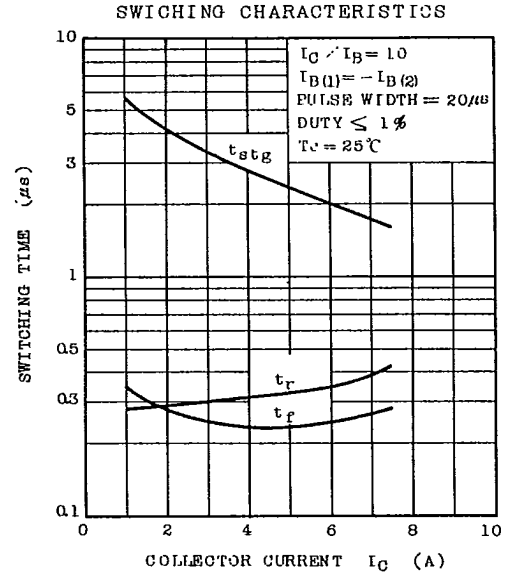
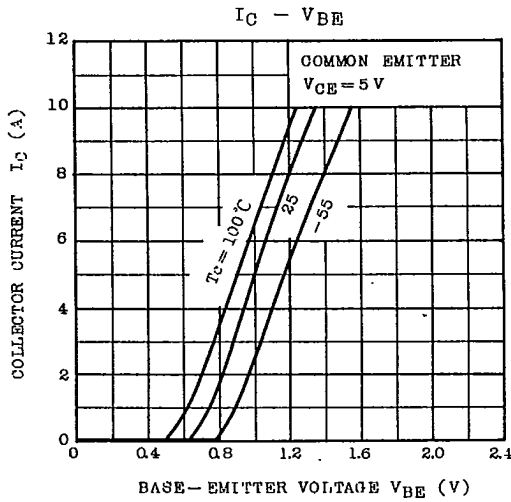

TOSHIBA CORPORATION