

DATA SHEET

BFQ621

NPN 7 GHz wideband transistor

Product specification
Supersedes data of 1995 Apr 11
File under Discrete Semiconductors, SC14

1995 Sep 26

NPN 7 GHz wideband transistor

BFQ621

FEATURES

- High power gain
- High output voltage
- High maximum junction temperature
- Gold metallization ensures excellent reliability.

APPLICATIONS

It is primarily intended for use in MATV and microwave amplifiers, such as aerial amplifiers, radar systems, oscilloscopes, spectrum analyzers, etc.

PINNING

PIN	DESCRIPTION
1	collector
2	emitter
3	base
4	emitter

DESCRIPTION

Silicon NPN transistor in a 4-lead dual-emitter SOT172A2 package with a ceramic cap. All leads are isolated from the mounting base. Emitter ballasting resistors and application of gold sandwich metallization ensures an optimum temperature profile and excellent reliability properties.

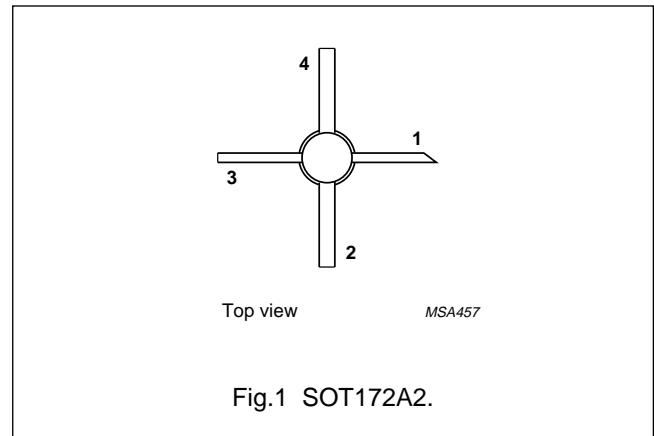

QUICK REFERENCE DATA

SYMBOL	PARAMETER	CONDITIONS	MIN.	TYP.	MAX.	UNIT
V_{CE0}	collector-emitter voltage	open base	–	–	16	V
I_C	collector current (DC)		–	–	150	mA
P_{tot}	total power dissipation	up to $T_{mb} = 25\text{ °C}$	–	–	8	W
h_{FE}	DC current gain	$I_C = 120\text{ mA}; V_{CE} = 18\text{ V}; T_{amb} = 25\text{ °C}$	40	–	–	
f_T	transition frequency	$I_C = 120\text{ mA}; V_{CE} = 18\text{ V}; f = 1\text{ GHz}; T_{amb} = 25\text{ °C}$	–	7	–	GHz
G_{UM}	maximum unilateral power gain	$I_C = 120\text{ mA}; V_{CE} = 18\text{ V}; f = 500\text{ MHz}; T_{amb} = 25\text{ °C}$	–	18.5	–	dB
V_O	output voltage	$I_C = 120\text{ mA}; V_{CE} = 18\text{ V}; f_{(p+q-r)} = 793.25\text{ MHz}; d_{im} = -60\text{ dB}; R_L = 75\text{ }\Omega$	–	1.2	–	V

WARNING

Product and environmental safety - toxic materials

This product contains beryllium oxide. The product is entirely safe provided that the BeO disc is not damaged. All persons who handle, use or dispose of this product should be aware of its nature and of the necessary safety precautions. After use, dispose of as chemical or special waste according to the regulations applying at the location of the user. It must never be thrown out with the general or domestic waste.

NPN 7 GHz wideband transistor

BFQ621

LIMITING VALUES

In accordance with the Absolute Maximum Rating System (IEC 134).

SYMBOL	PARAMETER	CONDITIONS	MIN.	MAX.	UNIT
V_{CBO}	collector-base voltage	open emitter	–	25	V
V_{CEO}	collector-emitter voltage	open base	–	16	V
V_{EBO}	emitter-base voltage	open collector	–	2	V
I_C	collector current (DC)		–	150	mA
P_{tot}	total power dissipation	up to $T_{mb} = 25\text{ °C}$	–	8	W
T_{stg}	storage temperature		–65	+175	°C
T_j	junction temperature		–	+200	°C

THERMAL CHARACTERISTICS

SYMBOL	PARAMETER	CONDITIONS	VALUE	UNIT
$R_{th\ j-mb}$	thermal resistance from junction to mounting base	$P_{tot} = 8\text{ W}$; up to $T_{mb} = 25\text{ °C}$	21.9	K/W

NPN 7 GHz wideband transistor

BFQ621

CHARACTERISTICS

$T_j = 25\text{ °C}$ (unless otherwise specified).

SYMBOL	PARAMETER	CONDITIONS	MIN.	TYP.	MAX.	UNIT
$V_{(BR)CBO}$	collector-base breakdown voltage	$I_C = 0.1\text{ mA}; I_E = 0$	–	–	25	V
$V_{(BR)CEO}$	collector-emitter breakdown voltage	$I_C = 10\text{ mA}; I_B = 0$	–	–	16	V
$V_{(BR)EBO}$	emitter-base breakdown voltage	$I_E = 0.1\text{ mA}; I_C = 0$	–	–	2	V
I_{CBO}	collector-base leakage current	$I_E = 0; V_{CB} = 18\text{ V}$	–	–	100	μA
h_{FE}	DC current gain	$I_C = 50\text{ mA}; V_{CE} = 10\text{ V}$	50	–	160	
f_T	transition frequency	$I_C = 120\text{ mA}; V_{CE} = 18\text{ V};$ $f = 1\text{ GHz};$ see Fig.3	–	7	–	GHz
C_c	collector capacitance	$I_E = i_e = 0; V_{CB} = 18\text{ V};$ $f = 1\text{ MHz}$	–	1.5	–	pF
C_e	emitter capacitance	$I_C = i_c = 0; V_{EB} = 0.5\text{ V};$ $f = 1\text{ MHz}$	–	5	–	pF
C_{re}	feedback capacitance	$I_C = 0; V_{CE} = 18\text{ V}; f = 1\text{ MHz};$ see Fig.4	–	0.85	1.2	pF
G_{UM}	maximum unilateral power gain; note 1	$I_C = 120\text{ mA}; V_{CE} = 18\text{ V};$ $f = 500\text{ MHz}; T_{amb} = 25\text{ °C};$	–	18.5	–	dB
		$I_C = 120\text{ mA}; V_{CE} = 18\text{ V};$ $f = 800\text{ MHz}; T_{amb} = 25\text{ °C};$	–	14.5	–	dB
V_O	output voltage	note 2	–	1.35	–	V
		note 3	–	1.2	–	V
d_2	second order intermodulation distortion	note 4	–	–60	–	dB
		note 5	–	–60	–	dB

Notes

- G_{UM} is the maximum unilateral power gain, assuming s_{12} is zero. $G_{UM} = 10 \log \frac{|s_{21}|^2}{(1 - |s_{11}|^2)(1 - |s_{22}|^2)}$ dB.
- $d_{im} = -60\text{ dB}$ (DIN45004B); see Fig.2; $I_C = 120\text{ mA}; V_{CE} = 18\text{ V}; R_L = 75\ \Omega; T_{amb} = 25\text{ °C};$
 $V_p = V_O; f_p = 445.25\text{ MHz};$
 $V_q = V_O - 6\text{ dB}; f_q = 453.25\text{ MHz};$
 $V_r = V_O - 6\text{ dB}; f_r = 455.25\text{ MHz};$
 measured at $f_{(p+q-r)} = 443.25\text{ MHz};$ see Fig.5.
- $d_{im} = -60\text{ dB}$ (DIN45004B); see Fig.2; $I_C = 120\text{ mA}; V_{CE} = 18\text{ V}; R_L = 75\ \Omega; T_{amb} = 25\text{ °C};$
 $V_p = V_O; f_p = 795.25\text{ MHz};$
 $V_q = V_O - 6\text{ dB}; f_q = 803.25\text{ MHz};$
 $V_r = V_O - 6\text{ dB}; f_r = 805.25\text{ MHz};$
 measured at $f_{(p+q-r)} = 793.25\text{ MHz};$ see Fig.6.
- $V_O = 50\text{ dBmV} = 316\text{ mV}; I_C = 90\text{ mA}; V_{CE} = 18\text{ V}; R_L = 75\ \Omega; T_{amb} = 25\text{ °C};$
 measured at $f_{(p+q)} = 450\text{ MHz};$ see Fig.7.
- $V_O = 50\text{ dBmV} = 316\text{ mV}; I_C = 90\text{ mA}; V_{CE} = 18\text{ V}; R_L = 75\ \Omega; T_{amb} = 25\text{ °C};$
 measured at $f_{(p+q)} = 810\text{ MHz};$ see Fig.8.

NPN 7 GHz wideband transistor

BFQ621

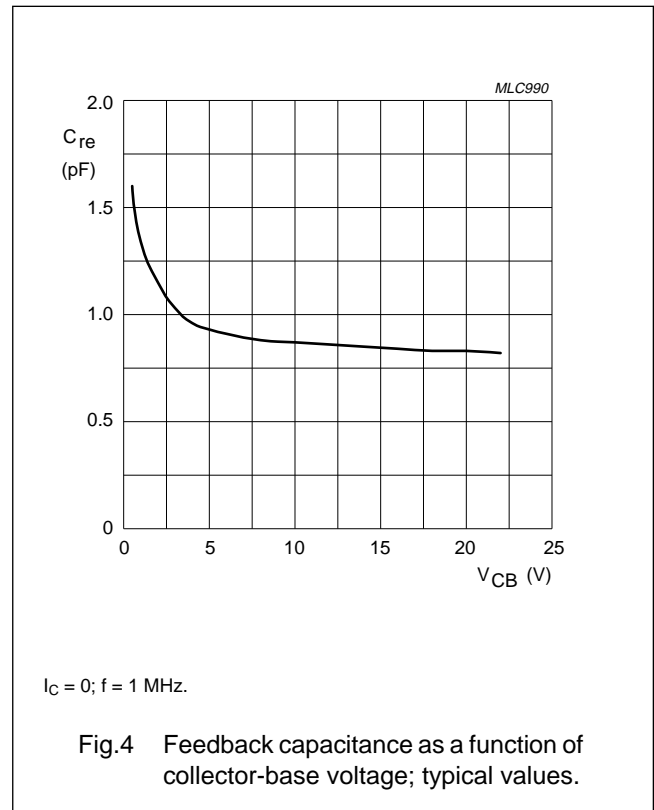
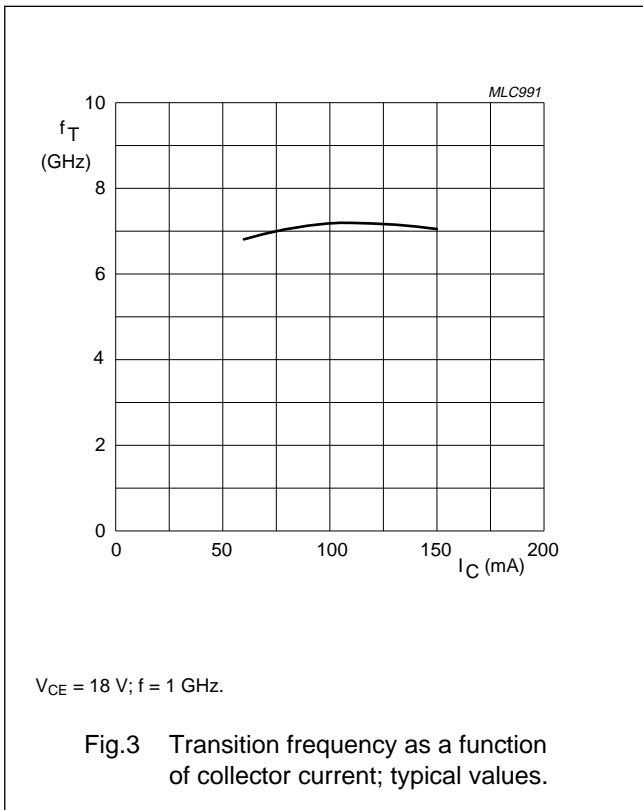
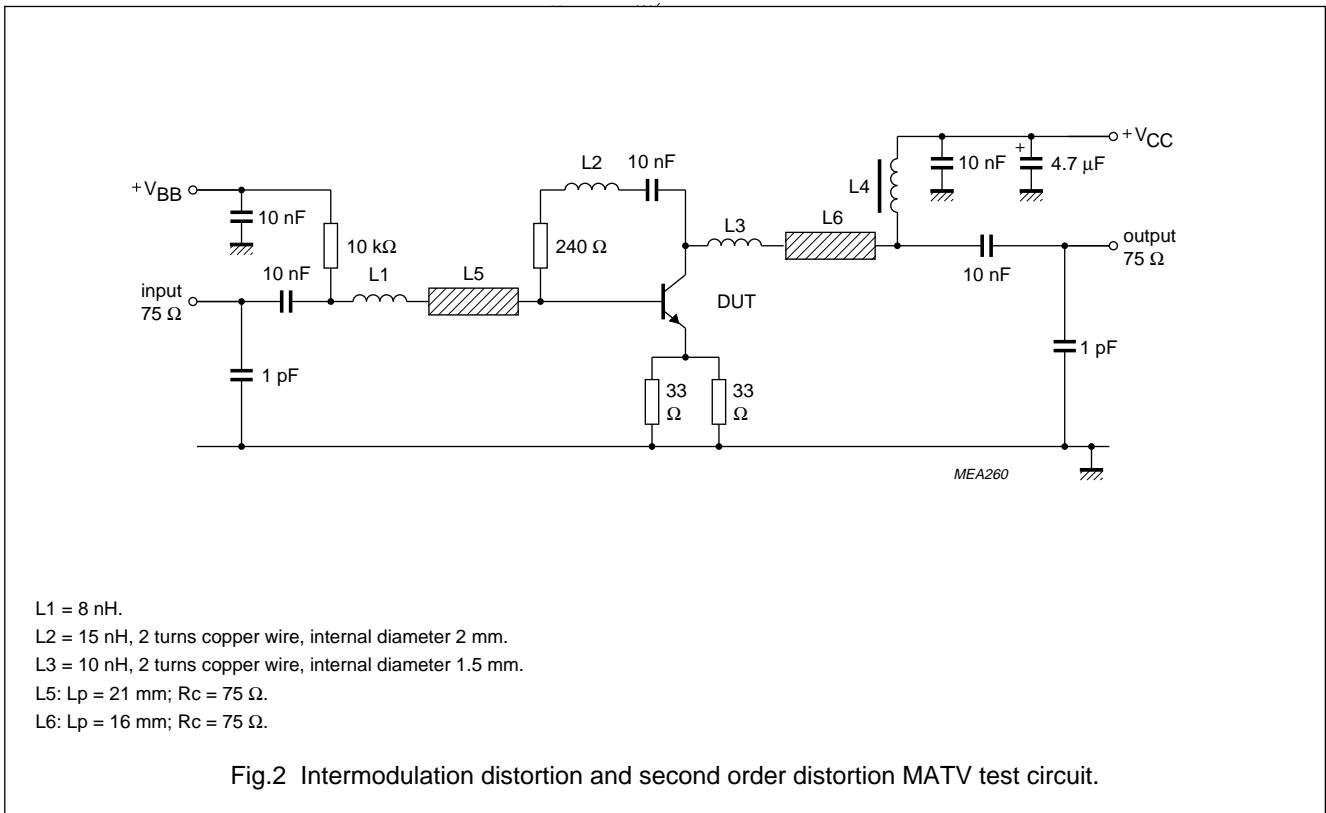

NPN 7 GHz wideband transistor

BFQ621

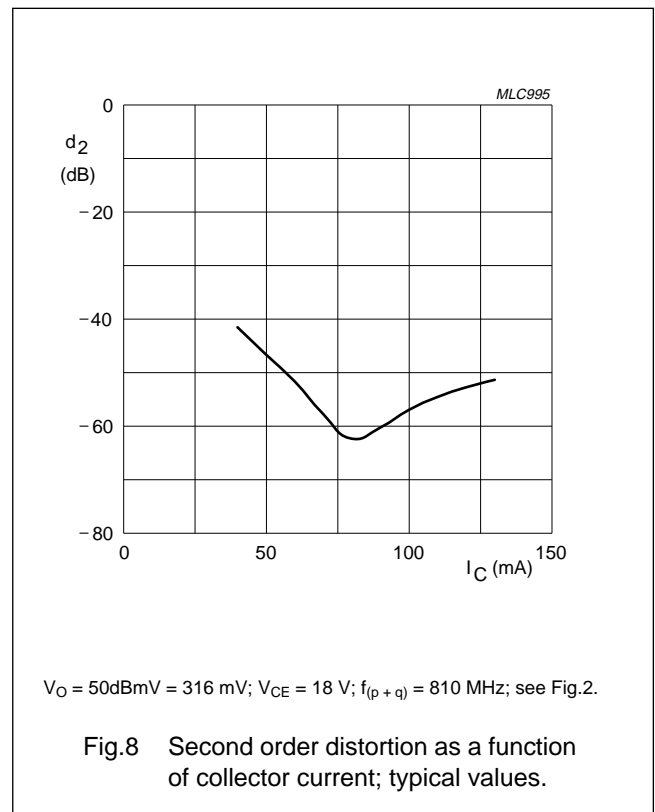
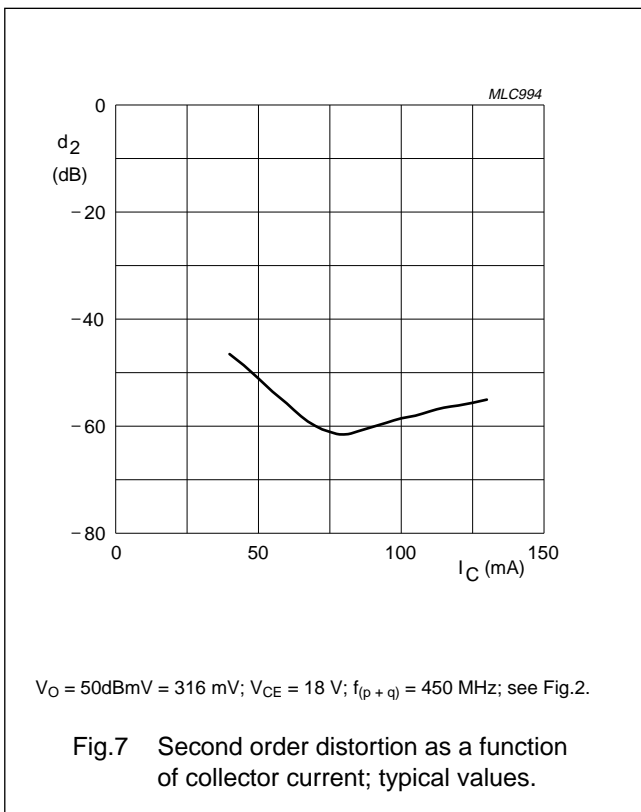
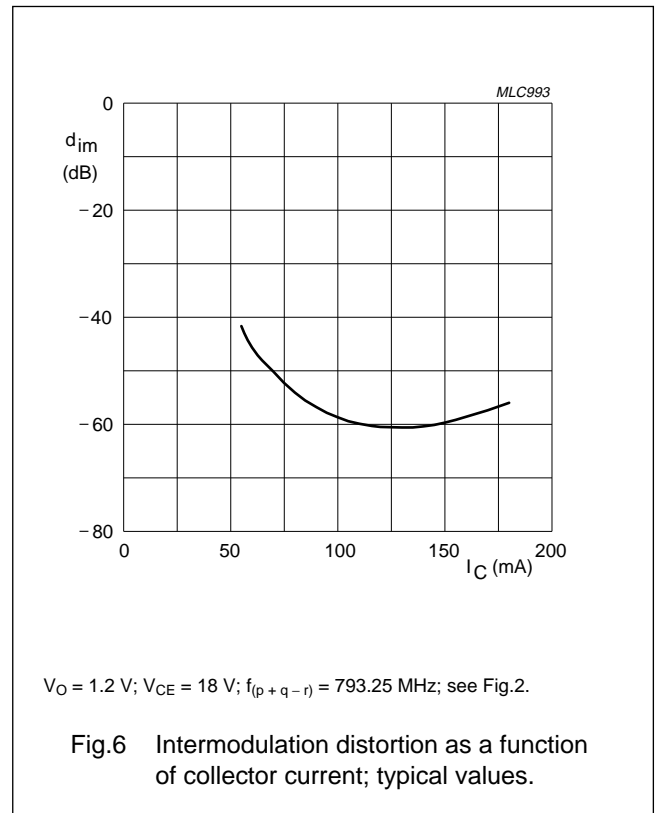
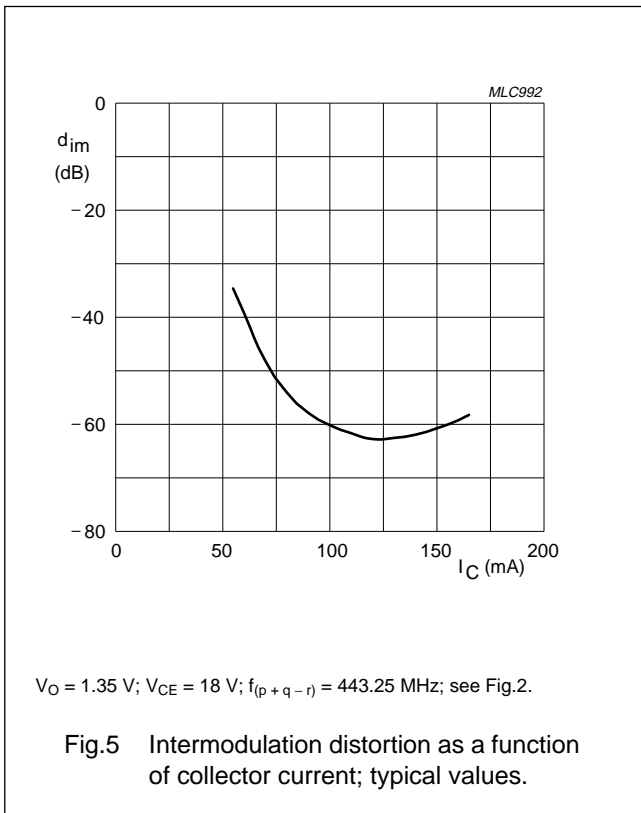

NPN 7 GHz wideband transistor

BFQ621

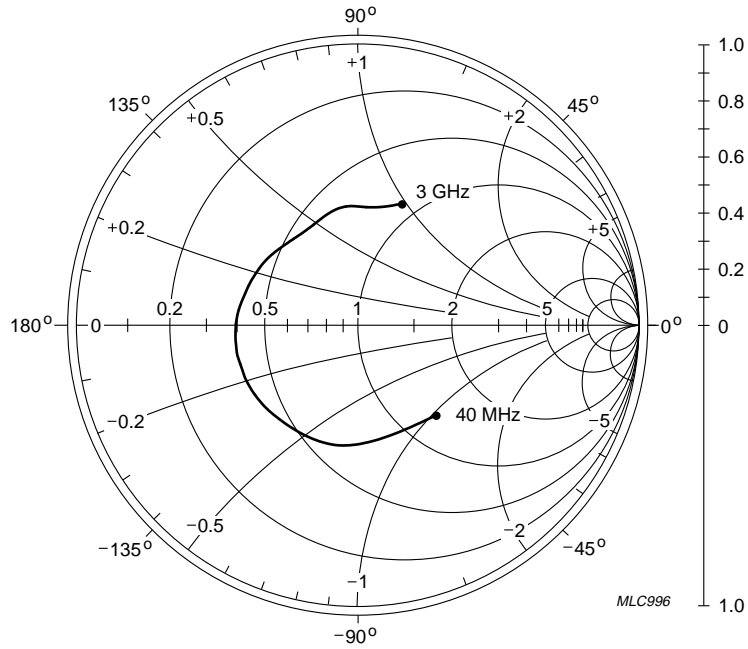

$V_{CE} = 18\text{ V}; I_C = 120\text{ mA}; Z_0 = 50\ \Omega.$

Fig.9 Common emitter input reflection coefficient (s_{11}); typical values.

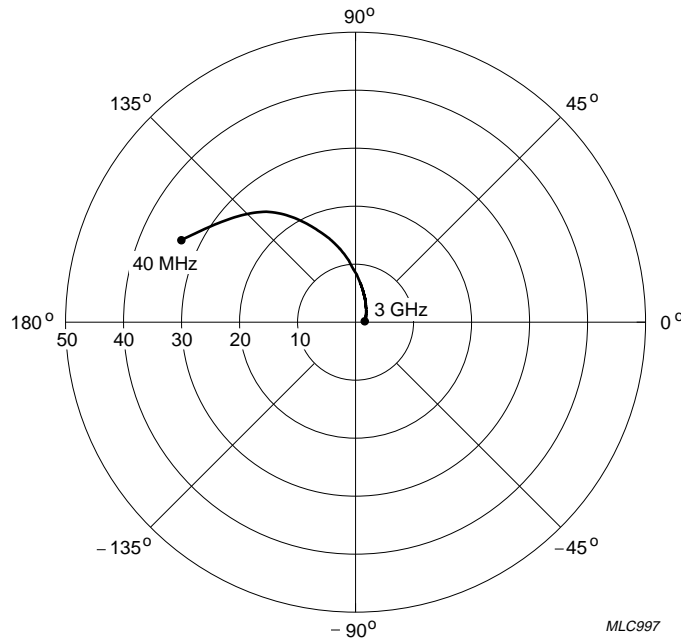

$V_{CE} = 18\text{ V}; I_C = 120\text{ mA}.$

Fig.10 Common emitter forward transmission coefficient (s_{21}); typical values.

NPN 7 GHz wideband transistor

BFQ621

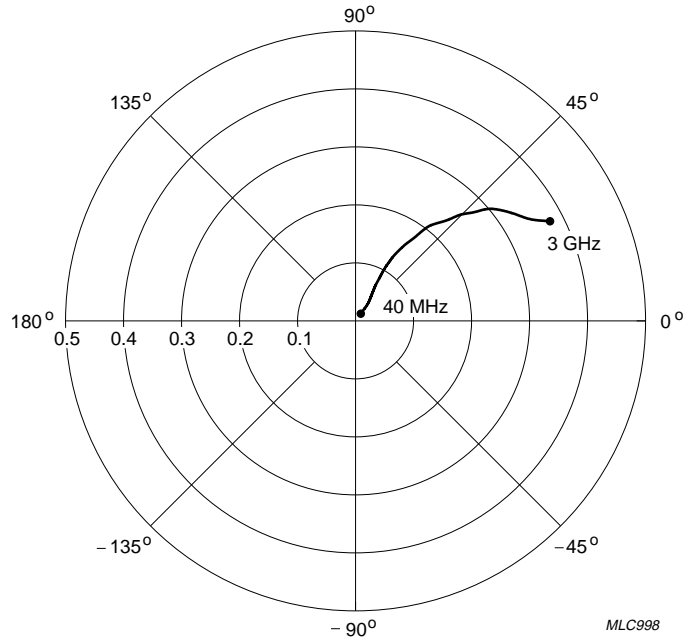

$V_{CE} = 18\text{ V}; I_C = 120\text{ mA}$.

Fig.11 Common emitter reverse transmission coefficient (s_{12}); typical values.

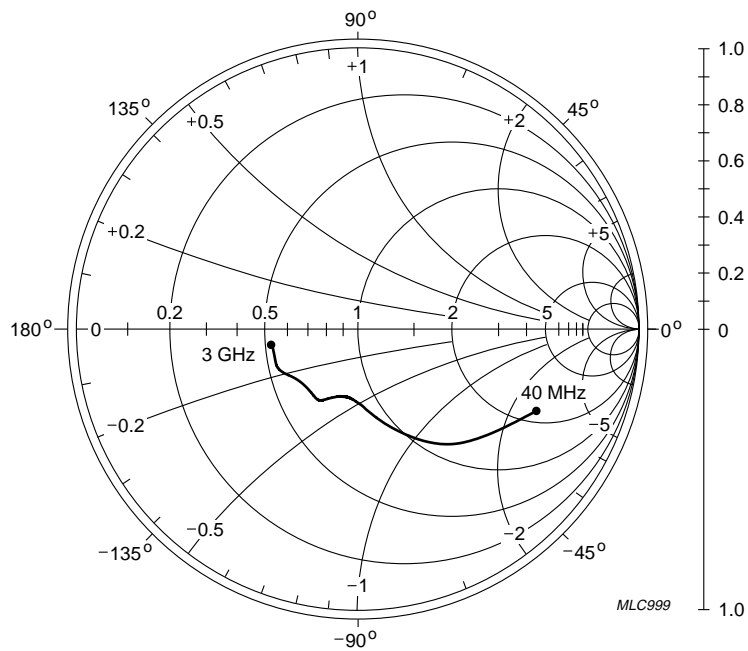

$V_{CE} = 18\text{ V}; I_C = 120\text{ mA}; Z_0 = 50\ \Omega$.

Fig.12 Common emitter output reflection coefficient (s_{22}); typical values.

NPN 7 GHz wideband transistor

BFQ621

SPICE parameters for the BFQ621 crystal

SEQUENCE No.	PARAMETER	VALUE	UNIT
1	IS	1.358	fA
2	BF	112.2	–
3	NF	0.991	–
4	VAF	78.06	V
5	IKF	4.291	A
6	ISE	643.3	fA
7	NE	1.851	–
8	BR	5.776	–
9	NR	0.999	–
10	VAR	2.350	V
11	IKR	50.26	mA
12	ISC	2.454	fA
13	NC	1.175	–
14	RB	8.000	Ω
15	IRB	1.000	μ A
16	RBM	8.000	Ω
17	RE	1.585	Ω
18	RC	1.880	Ω
19 ⁽¹⁾	XTB	0.000	–
20 ⁽¹⁾	EG	1.110	eV
21 ⁽¹⁾	XTI	3.000	–
22	CJE	3.985	pF
23	VJE	0.600	V
24	MJE	0.327	–
25	TF	14.02	ps
26	XTF	398.1	–
27	VTF	2.940	mV
28	ITF	3.084	A
29	PTF	45.00	deg
30	CJC	1.529	pF
31	VJC	0.216	V
32	MJC	0.158	–
33	XCJC	0.120	–
34	TR	9.070	ns
35 ⁽¹⁾	CJS	0.000	F
36 ⁽¹⁾	VJS	750.0	mV
37 ⁽¹⁾	MJS	0.000	–
38	FC	0.735	–

Note

- These parameters have not been extracted, the default values are shown.

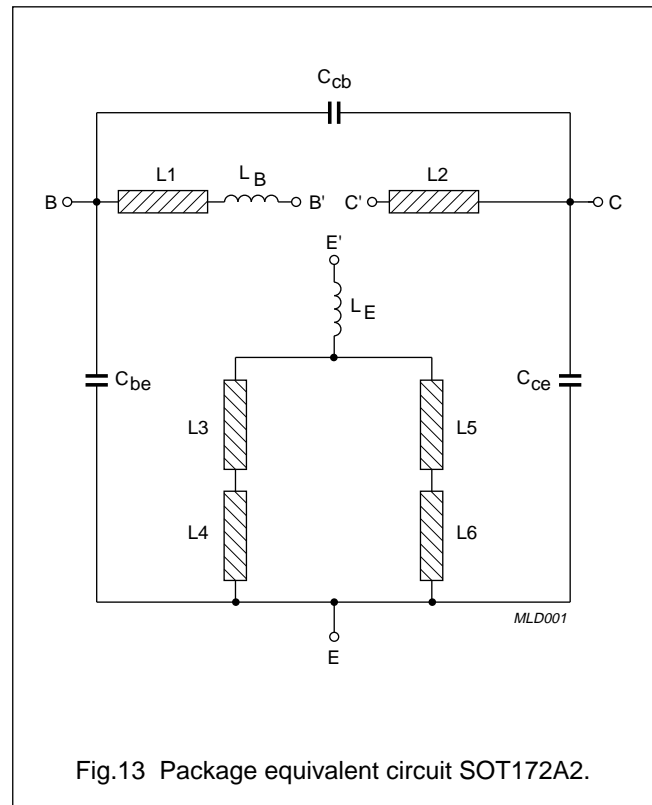

Fig.13 Package equivalent circuit SOT172A2.

List of components (see Fig.13)

DESIGNATION	VALUE	UNIT
C_{be}	225	fF
C_{cb}	36	fF
C_{ce}	362	fF
$L1^{(1)}$	$L = 1.37; W = 2.64$	mm
$L2^{(1)}$	$L = 1.60; W = 2.64$	mm
$L3^{(1)}$	$L = 0.51; W = 0.33$	mm
$L4^{(1)}$	$L = 0.81; W = 2.06$	mm
$L5^{(1)}$	$L = 2.77; W = 0.33$	mm
$L6^{(1)}$	$L = 0.94; W = 2.06$	mm
L_B	1.85	nH
L_E	1.22	nH

Note

- The micro striplines are on a double copper-clad substrate; $\epsilon_r = 6.5$; $h = 1.18$ mm.

NPN 7 GHz wideband transistor

BFQ621

PACKAGE OUTLINE

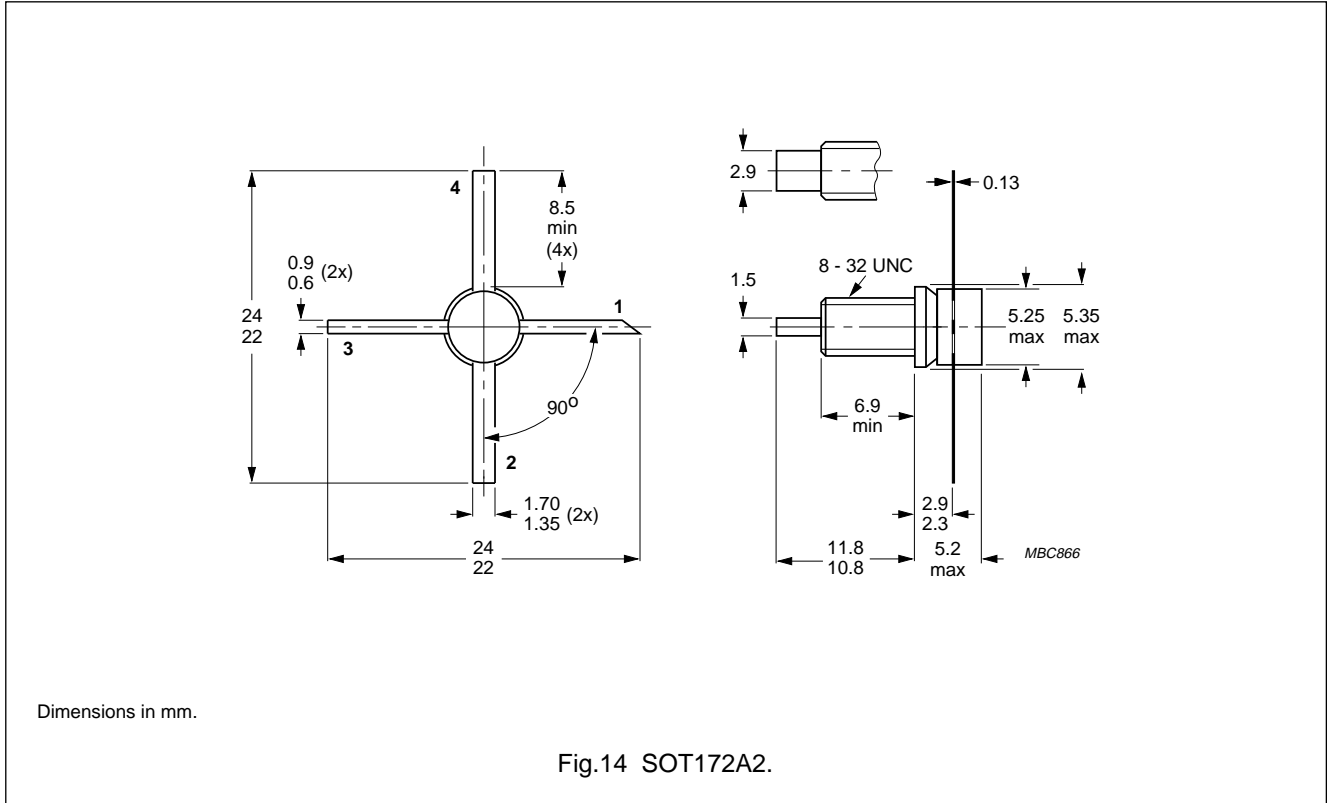

DEFINITIONS

Data sheet status	
Objective specification	This data sheet contains target or goal specifications for product development.
Preliminary specification	This data sheet contains preliminary data; supplementary data may be published later.
Product specification	This data sheet contains final product specifications.
Limiting values	
Limiting values given are in accordance with the Absolute Maximum Rating System (IEC 134). Stress above one or more of the limiting values may cause permanent damage to the device. These are stress ratings only and operation of the device at these or at any other conditions above those given in the Characteristics sections of the specification is not implied. Exposure to limiting values for extended periods may affect device reliability.	
Application information	
Where application information is given, it is advisory and does not form part of the specification.	

LIFE SUPPORT APPLICATIONS

These products are not designed for use in life support appliances, devices, or systems where malfunction of these products can reasonably be expected to result in personal injury. Philips customers using or selling these products for use in such applications do so at their own risk and agree to fully indemnify Philips for any damages resulting from such improper use or sale.



LittleDiode supplies new, hard to find or obsolete electronic components and semiconductors all over the world.

With over two million different components listed you are sure to find the part you need.

Feel free to visit us today at our online store:

LittleDiode.com

Looking forward to providing you with the best possible service.