

File Number 1172

BUX21

Silicon N-P-N Switching Transistor

For Switching Applications in
Industrial and Commercial Equipment

Features:

- $V_{CE0} - 200V$
- $I_C - 40 A$
- $P_T - 250 W$

TERMINAL DESIGNATIONS

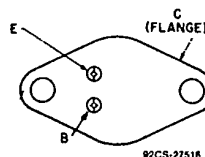

JEDEC TO-204AA

The RCA-BUX21 is a silicon n-p-n power transistor featuring fast switching speeds, low saturation voltage, and high safe-operating-area (SOA) ratings. It is specially designed for converters, inverters, pulse-width-modulated regulators, and a variety of power switching circuits.

The RCA-BUX21 transistor is supplied in a steel JEDEC TO-204AA hermetic package.

MAXIMUM RATINGS, Absolute-Maximum Values:

	BUX21	
V_{CBO}	250	V
$V_{CE0(SUS)}$	200	V
$V_{CEX(SUS)}$ $V_{BE} = -1.5V$	250	V
$V_{CER(SUS)}$ $R_{BE} = 100 \Omega$	240	V
V_{EBO}	7	V
I_C	40	A
I_{CM}	50	A
I_B	8	A
P_T At T_C up to 25°C and V_{CE} up to 20 V	250	W
T_J, T_{stg}	-65 to +200	°C
T_L At distances $\geq 1/16$ in. (1.58 mm) from case for 10 s max.	200	°C

3875081 G E SOLID STATE
Pro Electron Power Transistors

01E 17609 DT-33-15

BUX21

ELECTRICAL CHARACTERISTICS, at Case Temperature (T_C) = 25°C unless otherwise specified

CHARACTERISTIC	TEST CONDITIONS				LIMITS			UNITS
	VOLTAGE V dc		CURRENT A dc		BUX21			
	V_{CE}	V_{BE}	I_C	I_B	Min.	Typ.	Max.	
I_{CEO}	160	-	-	0	-	-	3	mA
I_{CEV}	250	-1.5	-	-	-	-	3	
$T_C = 125^\circ C$	250	-1.5	-	-	-	-	12	
I_{EBO}	-	-5	0	-	-	-	1	
$V_{CEO(sus)}^b$	-	-	0.2 ^a	-	200 ^a	-	-	V
$V_{(BR)EBO} I_E = 0.05 A$	-	-	0	-	7	-	-	V
$V_{BE(sat)}$	-	-	25 ^a	3	-	1.2	1.5	
$V_{CE(sat)}$	-	-	12 ^a 25 ^a	1.2 3	-	0.2 0.7	0.6 1.5	
h_{FE}	2 4	-	12 ^a 25 ^a	-	20 10	-	60	
$I_{S/b}$ $t = 1s, nonrepetitive$	140 20	-	-	-	0.15 12.5	-	-	A
f_T $f = 10 MHz$	15	-	2	-	8	-	-	MHz
t_{on}	$V_{CC} = 100 V$	-	25	3	-	0.3	1.2	μs
t_s ($I_{B1} = I_{B2}$)	$V_{CC} = 100 V$	-	25	3	-	1.0	1.8	
t_f ($I_{B1} = I_{B2}$)	$V_{CC} = 100 V$	-	25	3	-	0.2	0.4	
$R_{\theta JC}$	-	-	-	-	-	-	0.7	$^\circ C/W$

^a Pulsed, pulse duration = 300 μs , duty factor $\leq 2\%$.

^b CAUTION: Sustaining Voltages $V_{CEO(sus)}$ MUST NOT be measured on a curver tracer.

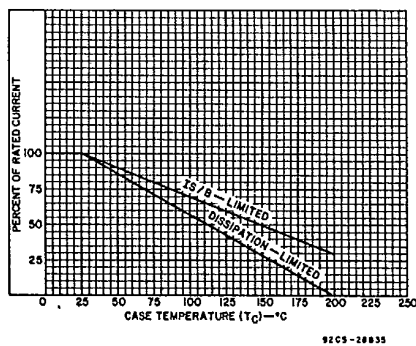

Fig. 1 - Dissipation and $I_{S/b}$ derating curve.

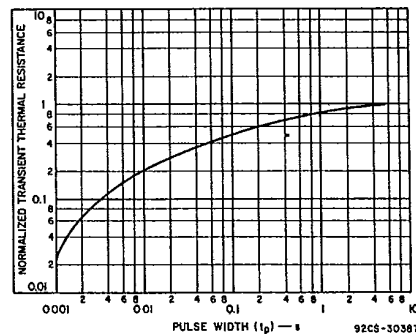

Fig. 2 - Typical thermal-response characteristic.

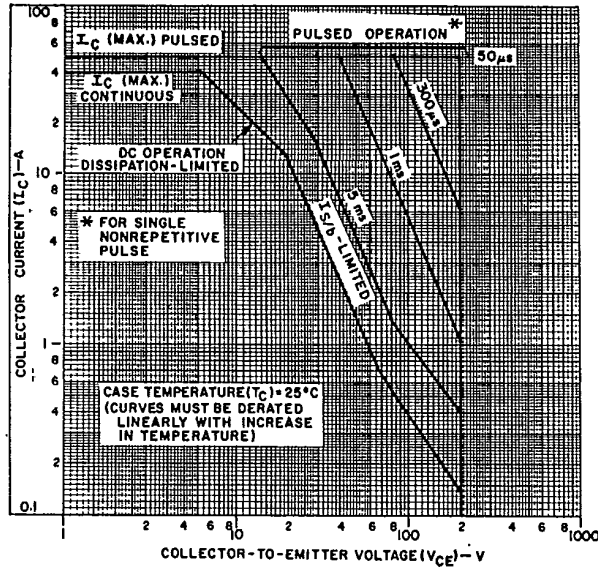

Fig. 3 — Maximum operating areas ($T_C = 25^\circ C$), 92CM-31448

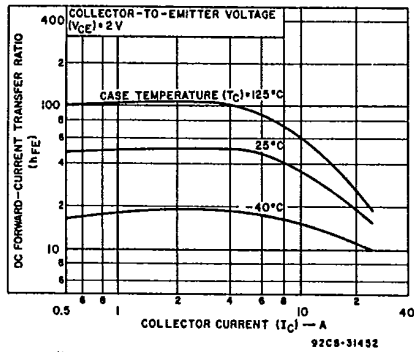

Fig. 4 — Typical dc beta characteristics, 92CS-31452

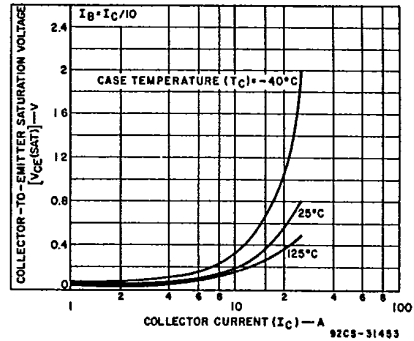

Fig. 5 — Typical collector-to-emitter saturation voltage characteristics, 92CS-31453

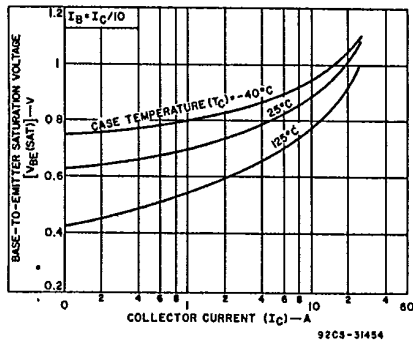

Fig. 6 — Typical base-to-emitter saturation voltage characteristics, 92CS-31454

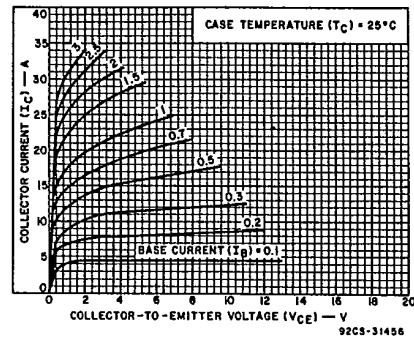

Fig. 7 — Typical output characteristics, 92CS-31456

3875081 G E SOLID STATE
Pro Electron Power Transistors

01E 17611 0 T-33-15

BUX21

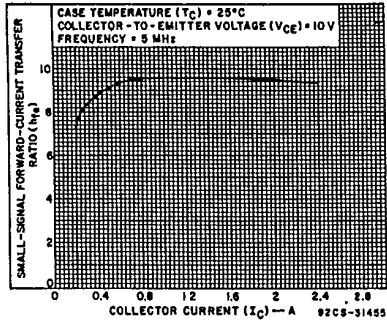

Fig. 8 — Typical small-signal forward-current transfer ratio characteristics.

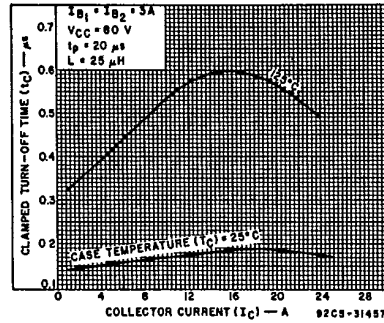

Fig. 9 — Typical clamped turn-off time characteristics.

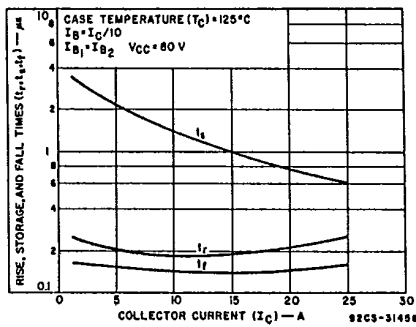

Fig. 10 — Typical saturated-switching-time characteristics as a function of collector current.

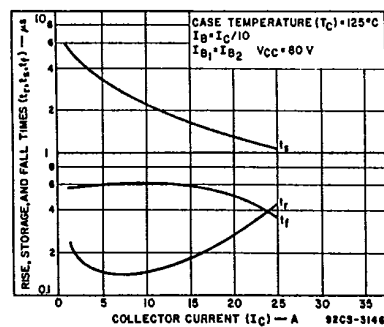

Fig. 11 — Typical-switching-time characteristics at $T_C = 125^\circ C$ as a function of collector current.

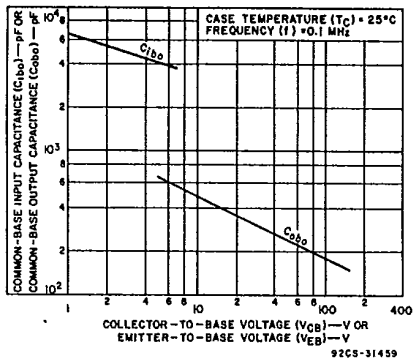

Fig. 12 — Typical common-base input (C_{ibo}) or output (C_{obo}) capacitance characteristics.

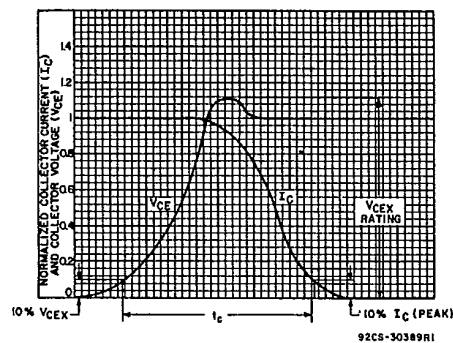

Fig. 13 — Oscilloscope display for normalized measurement of clamped inductive switching time (t_c).

BUX21

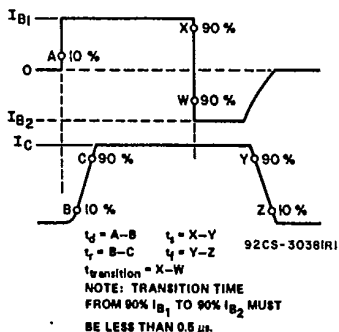

Fig. 14 — Phase relationship between input and output currents showing reference points for specification of switching times.

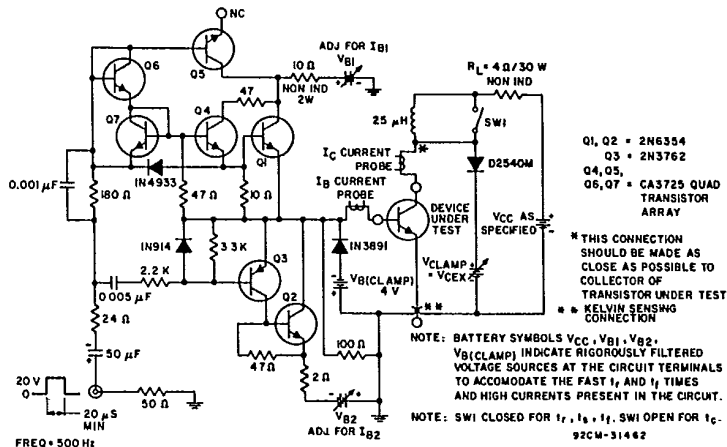

Fig. 15 — Circuit for measuring switching times.



LittleDiode supplies new, hard to find or obsolete electronic components and semiconductors all over the world.

With over two million different components listed you are sure to find the part you need.

Feel free to visit us today at our online store:

LittleDiode.com

Looking forward to providing you with the best possible service.