

SIEMENS AKTIENGESELLSCHAFT

Main ratings

Drain-source voltage $V_{DS} = 100\text{ V}$
 Continuous drain current $I_D = 10\text{ A}$
 Drain-source on-resistance $R_{DS(on)} = 0,2\ \Omega$

N-Channel

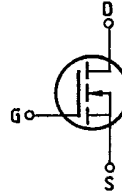

Description SIPMOS, N-channel, enhancement mode
 Case Metal case 3A2 in accordance with DIN 41872,
 or TO 204 AA (TO 3) in accordance with JEDEC.
 Approx. weight 12 g

Type	Ordering code
BUZ 23	C67078-A1002-A2

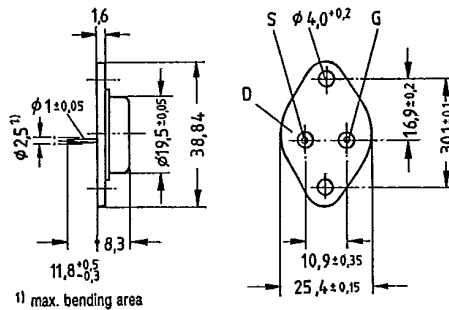

Dimensions in mm

Maximum ratings

Description	Symbols	Ratings	Units	Conditions
Drain-source voltage	V_{DS}	100	V	
Drain-gate voltage	V_{DGR}	100	V	$R_{GS} = 20\text{ k}\Omega$
Continuous drain current	I_D	10	A	$T_C = 85\text{ }^\circ\text{C}$
Pulsed drain current	$I_{D,puls}$	40	A	$T_C = 25\text{ }^\circ\text{C}$
Gate-source voltage	V_{GS}	± 20	V	
Max. power dissipation	P_D	78	W	$T_C = 25\text{ }^\circ\text{C}$
Operating and storage temperature range	T_j T_{stg}	$-55 \dots +150$	$^\circ\text{C}$	
DIN humidity category	C			DIN 40040
IEC climatic category	55/150/56			DIN IEC 68-1

Thermal resistance

Chip - case	$R_{th,jc}$	$\leq 1,6$	K/W
Chip - ambient	$R_{th,ja}$	≤ 35	K/W

220 Preferred Type

0802 A-13

SIEMENS AKTIENGESELLSCHAFT

Electrical characteristics(at $T_j = 25^\circ\text{C}$ unless otherwise specified)

Description	Symbol	Characteristics			Unit	Conditions
		min.	typ.	max.		

Static ratings

Drain-source breakdown voltage	$V_{(BR)DSS}$	100	—	—	V	$V_{GS} = 0V$ $I_D = 0,25mA$
Gate threshold voltage	$V_{GS(th)}$	2,1	3,0	4,0		$V_{DS} = V_{GS}$ $I_D = 1mA$
Zero gate voltage drain current	I_{DSS}	—	20	250	μA	$T_j = 25^\circ C$ $T_j = 125^\circ C$ $V_{DS} = 100V$ $V_{GS} = 0V$
Gate-source leakage current	I_{GSS}	—	10	100	nA	$V_{GS} = 20V$ $V_{DS} = 0V$
Drain-source on-resistance	$R_{DS(on)}$	—	0,15	0,2	Ω	$V_{GS} = 10V$ $I_D = 6A$

Dynamic ratings

Forward transconductance	g_{fs}	2,7	4,0	—	S	$V_{DS} = 25V$ $I_D = 6A$
Input capacitance	C_{iss}	—	1500	2000	pF	$V_{GS} = 0V$ $V_{DS} = 25V$ $f = 1MHz$
Output capacitance	C_{oss}	—	300	500		
Reverse transfer capacitance	C_{rss}	—	80	140		
Turn-on time t_{on} ($t_{on} = t_{d(on)} + t_r$)	$t_{d(on)}$	—	30	45	ns	$V_{CC} = 30V$ $I_D = 2,9A$ $V_{GS} = 10V$ $R_{GS} = 50\Omega$
	t_r	—	50	75		
Turn-off time t_{off} ($t_{off} = t_{d(off)} + t_f$)	$t_{d(off)}$	—	110	140	ns	
	t_f	—	60	80		

Reverse diode

Continuous reverse drain current	I_{DR}	—	—	10	A	$T_C = 25^\circ C$
Pulsed reverse drain current	I_{DRM}	—	—	40		
Diode forward on-voltage	V_{SD}	—	1,3	1,6	V	$I_F = 2 \times I_{DR}$ $V_{GS} = 0V, T_j = 25^\circ C$
Reverse recovery time	t_{rr}	—	200	—	ns	$T_j = 25^\circ C$
Reverse recovery charge	Q_{rr}	—	1,6	—	μC	$I_F = I_{DR}$ $d_{F/dt} = 100A/\mu s$ $V_R = 30V$

SIEMENS AKTIENGESELLSCHAFT

Power dissipation $P_D = f(T_C)$

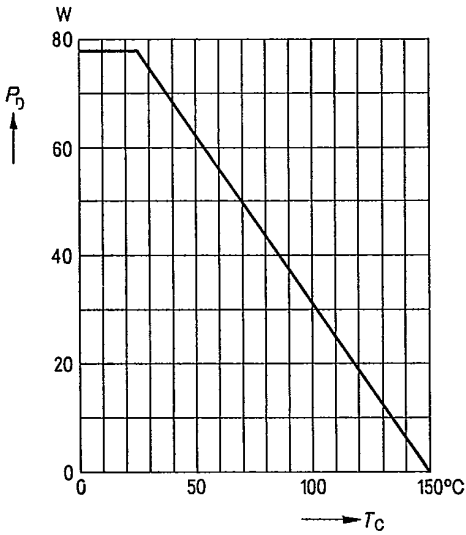

Typical output characteristics $I_D = f(V_{DS})$
 parameter: 80 μ s pulse test,
 $T_I = 25^\circ\text{C}$

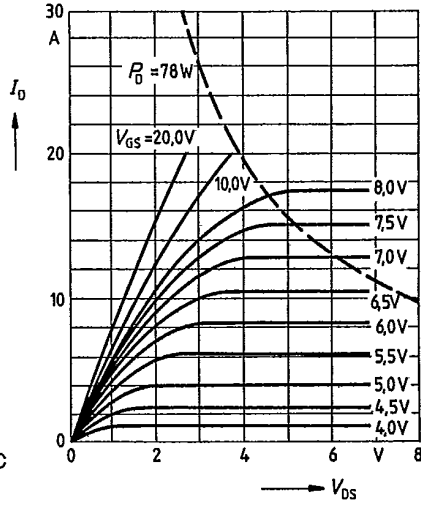

Safe operating area $I_D = f(V_{DS})$
 parameter: $D = 0.01$, $T_C = 25^\circ\text{C}$

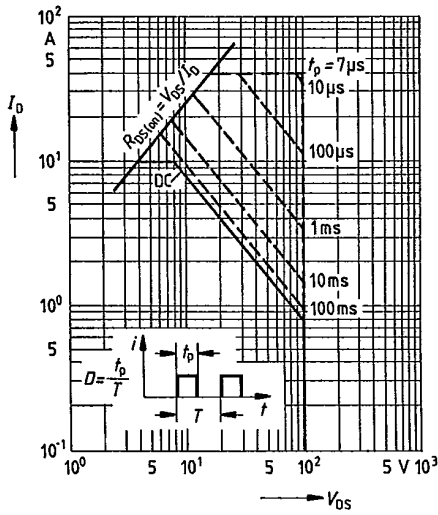

Typical transfer characteristic $I_D = f(V_{GS})$
 parameter: 80 μ s pulse test,
 $V_{DS} = 25\text{V}$, $T_I = 25^\circ\text{C}$

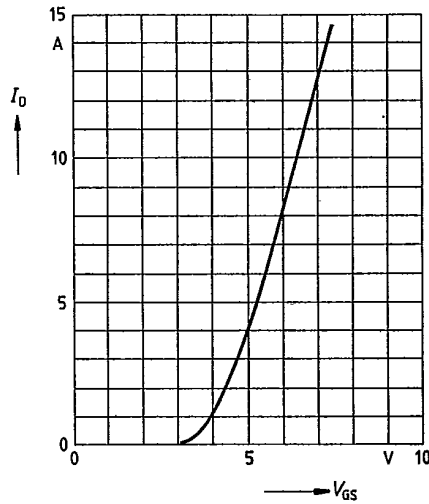

SIEMENS AKTIENGESELLSCHAFT

Typical drain-source on-state resistance

$R_{DS(on)} = f(I_D)$
parameter: $V_{GS} = 10V, T_j = 25^\circ C$

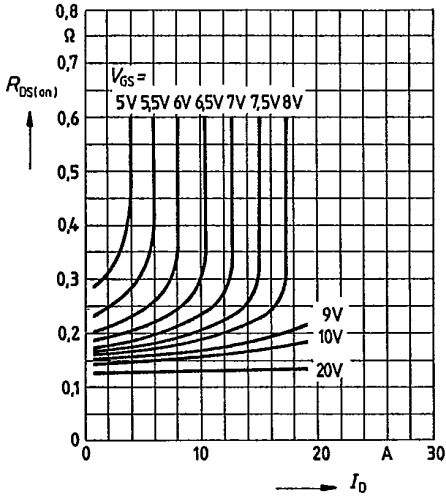

Drain-source on-state resistance

$R_{DS(on)} = f(T_j)$
parameter: $I_D = 6A, V_{GS} = 10V$
(spread)

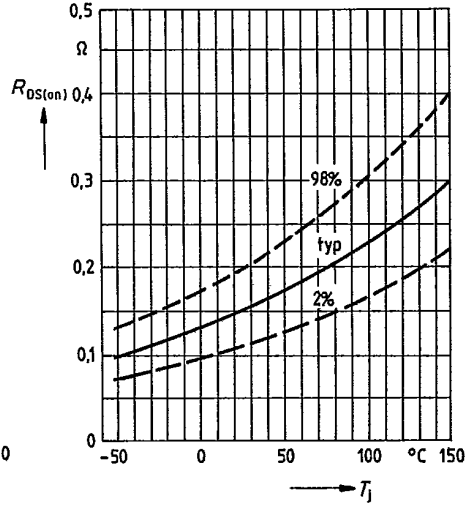

Typical transconductance $g_{fs} = f(I_D)$

parameter: 80 μs pulse test,
 $V_{DS} = 25V, T_j = 25^\circ C$

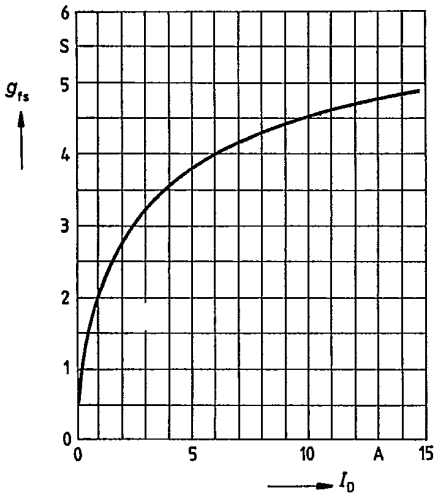

Gate threshold voltage $V_{GS(th)} = f(T_j)$

parameter: $V_{DS} = V_{GS}, I_D = 1mA$
(spread)

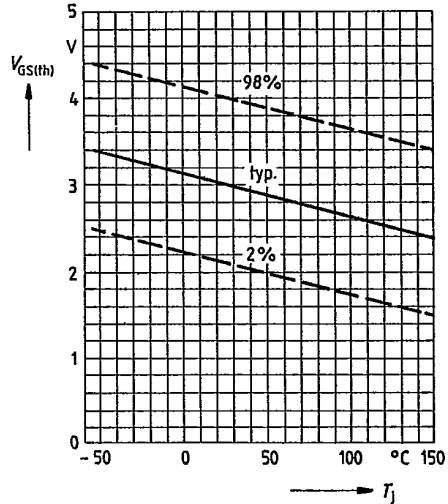

SIEMENS AKTIENGESELLSCHAFT

Typical capacitances $C = f(V_{GS})$
 parameter: $V_{GS} = 0, f = 1\text{MHz}$

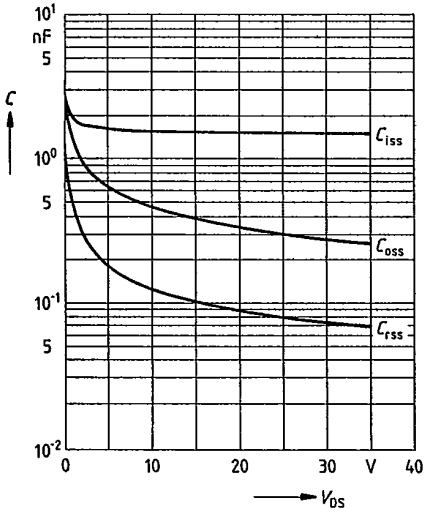

Continuous drain current $I_D = f(T_C)$
 parameter: $V_{GS} \geq 10\text{V}$

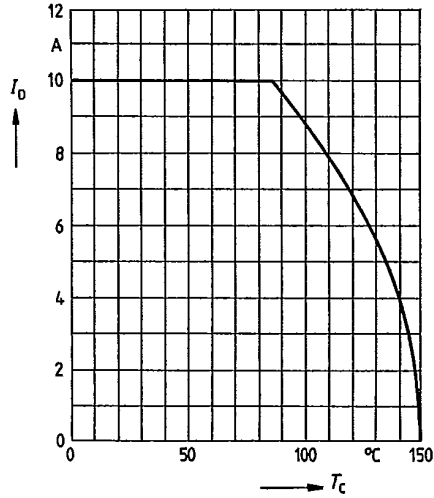

Forward characteristic of reverse diode

$I_F = f(V_{SD})$
 parameter: $T_j, t_p = 80 \mu\text{s}$
 (spread)

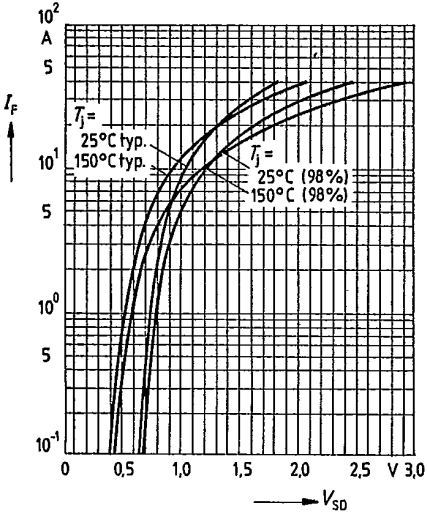

SIEMENS AKTIENGESELLSCHAFT

Transient thermal impedance $Z_{thJC} = f(t)$
 parameter: $D = t_p/T$

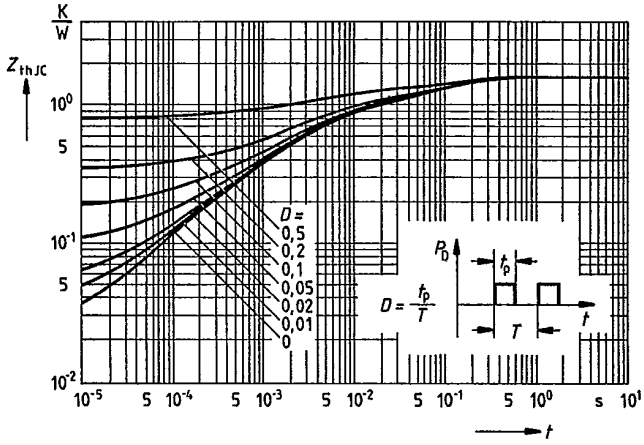

Typical gate-charge $V_{GS} = f(Q_{Gate})$
 parameter: $I_{D\ puls} = 18A$

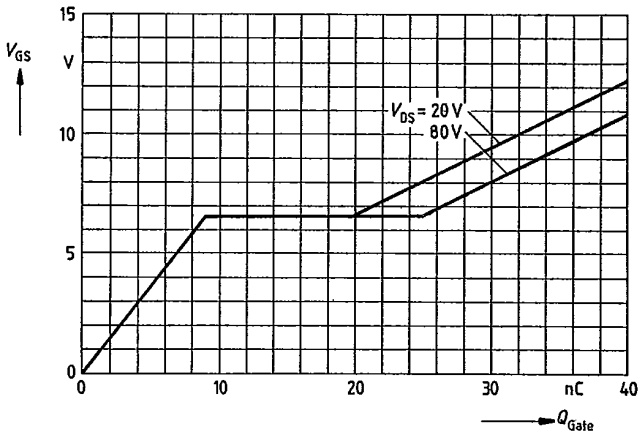



LittleDiode supplies new, hard to find or obsolete electronic components and semiconductors all over the world.

With over two million different components listed you are sure to find the part you need.

Feel free to visit us today at our online store:

LittleDiode.com

Looking forward to providing you with the best possible service.