

MITSUBISHI RF POWER MOS FET
2SK2973

DESCRIPTION

2SK2973 is a MOS FET type transistor specifically designed for VHF/UHF power amplifiers applications.

FEATURES

- High power gain:G_{pe} 13dB
 @V_{DD}=9.6V,f=450MHz,P_{in}=17dBm
- High efficiency:55% typ.
- Source case type SOT-89 package
 (connected internally to source)

APPLICATION

For drive stage and output stage of power amplifiers in VHF/UHF band portable radio sets.

OUTLINE DRAWING

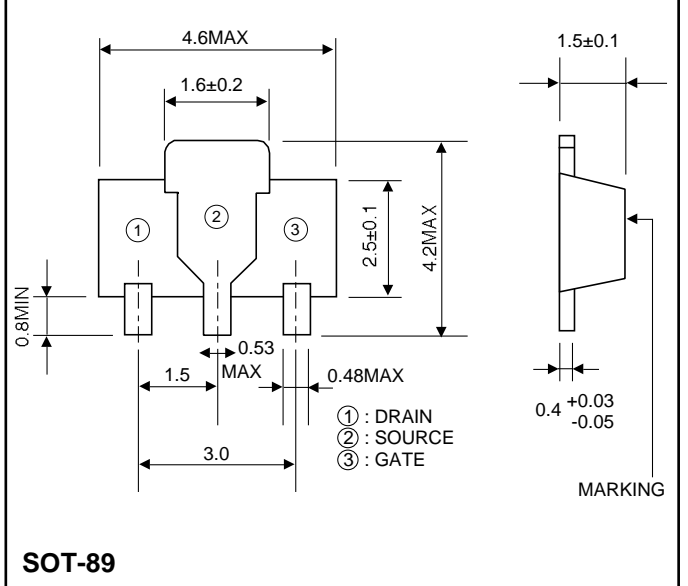

MARKING

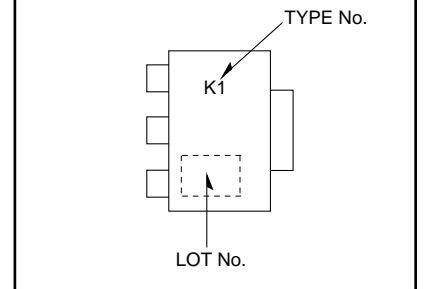

ABSOLUTE MAXIMUM RATINGS (T_c=25°C, unless otherwise noted)

Symbol	Parameter	Conditions	Ratings	Unit
V _{DSS}	Drain to source voltage		17	V
V _{GSS}	Gate to source voltage		±10	V
P _{ch}	Channel dissipation	T _c =25°C (Note2)	1.5	W
T _j	Junction temperature		150	°C
T _{stg}	Storage temperature		-40 to +110	°C

Note1: Above parameters are guaranteed independently.
 2: Solder on printed board(Copper leaf area;70×70mm,t=1.6mm Epoxy glass)

ELECTRICAL CHARACTERISTICS (T_c=25°C, unless otherwise noted)

Symbol	Parameter	Test conditions	Limits			Unit
			Min	Typ	Max	
I _{DSS}		V _{Ds} =12V, V _{Gs} =0V	—	—	10	μA
I _{GSS}		V _{Gs} =10V, V _{Ds} =0V	—	—	1	μA
V _{TH}	Threshold voltage	V _{Ds} =7V, I _{Ds} =1mA	1.2		1.8	V
C _{iss}		V _{Gs} =10V, V _{Ds} =0V,f=1MHz		10		pF
C _{oss}		V _{Ds} =10V, V _{Gs} =0V,f=1MHz		8		pF
P _{out}		V _{Ds} =9.6V, P _{in} =50mW,f=450MHz	1	1.2		W
h _D			45	55		%

Note: Above parameters,ratings,limits and conditions are subject to change.

TYPICAL PERFORMANCE DATA

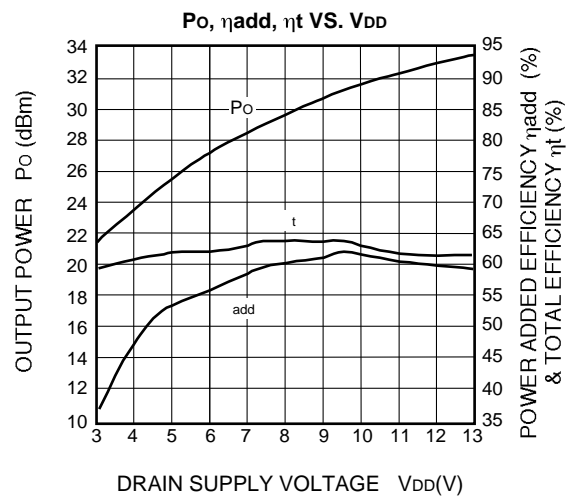
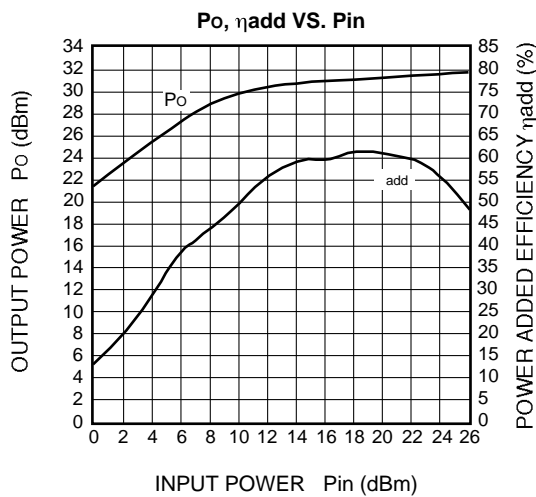
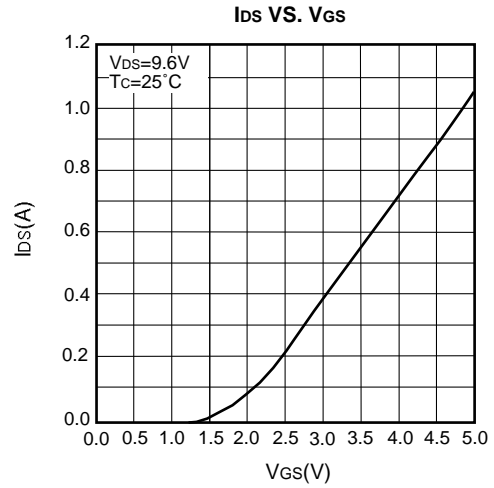
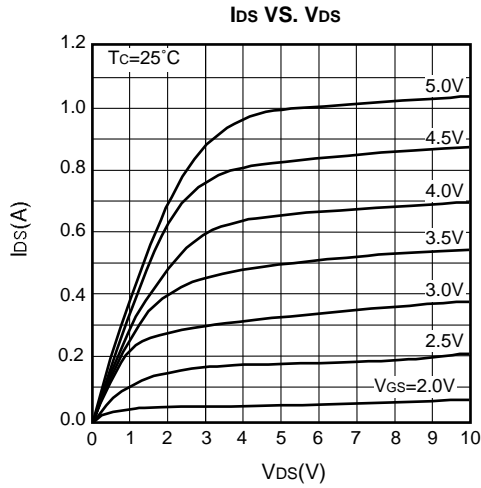

EQUIVALENT CIRCUIT

@ $V_{DD}=9.6\text{V}$ Match

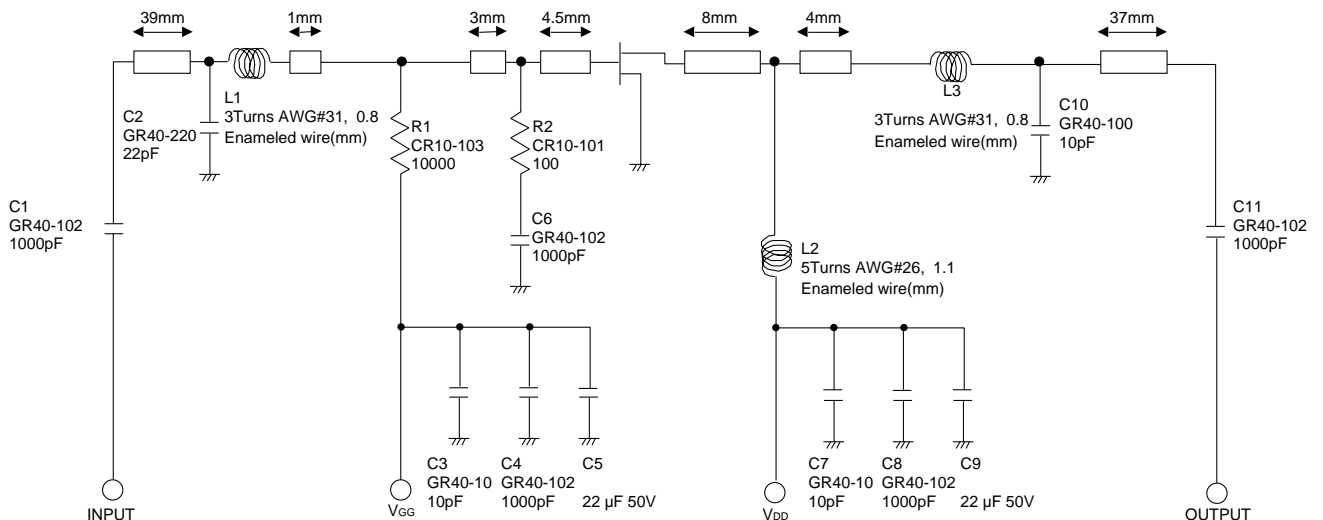

Note: Board material-glass epoxy substrate
micro strip line width=1mm, $r : 4.8, t : 0.6\text{mm}$

MITSUBISHI RF POWER MOS FET
2SK2973

S-PARAMETER DATA(TYPICAL)

V_{DD}=7V, I_D=100mA

FREQ. (MHz)	S ₁₁		S ₁₂		S ₂₁		S ₂₂	
	Real	Imag	Real	Imag	Real	Imag	Real	Imag
50	0.962	-30.909	0.019	70.131	15.173	155.450	0.517	-33.518
100	0.877	-57.078	0.030	55.726	13.006	134.869	0.497	-60.987
150	0.797	-76.635	0.036	44.160	10.709	119.517	0.482	-80.439
200	0.741	-91.748	0.038	40.231	8.877	107.569	0.475	-94.398
250	0.711	-103.034	0.038	38.866	7.448	97.989	0.478	-103.912
300	0.691	-111.898	0.036	41.687	6.331	90.515	0.482	-111.111
350	0.683	-119.086	0.036	45.980	5.489	83.918	0.490	-117.019
400	0.680	-125.145	0.036	54.414	4.833	78.172	0.504	-121.733
450	0.680	-130.461	0.038	62.799	4.299	73.186	0.515	-125.706
500	0.684	-135.027	0.041	70.422	3.863	68.210	0.528	-129.494
550	0.689	-139.643	0.047	77.349	3.488	63.808	0.538	-132.827
600	0.695	-143.458	0.054	81.691	3.180	59.700	0.550	-136.175
650	0.704	-147.473	0.062	85.975	2.937	55.733	0.563	-139.265
700	0.710	-151.333	0.072	88.284	2.710	51.615	0.575	-142.636
750	0.719	-154.997	0.082	89.530	2.509	48.016	0.587	-145.786
800	0.725	-158.593	0.094	89.900	2.346	44.142	0.599	-149.500
850	0.736	-162.473	0.106	89.449	2.190	40.196	0.607	-152.741
900	0.739	-166.136	0.118	88.195	2.032	36.568	0.614	-156.200
950	0.751	-169.642	0.131	86.908	1.910	32.944	0.628	-159.932
1000	0.759	-173.163	0.145	85.477	1.767	29.492	0.632	-163.560
1050	0.763	-176.805	0.158	83.221	1.663	26.400	0.640	-167.393
1100	0.772	-179.819	0.170	81.026	1.561	23.026	0.648	-171.167
1150	0.777	-176.141	0.183	78.964	1.448	19.886	0.654	-174.329
1200	0.788	-172.631	0.195	76.775	1.351	17.290	0.656	-177.882
1250	0.793	-169.504	0.207	74.515	1.263	14.209	0.659	-178.966
1300	0.797	-165.990	0.220	72.443	1.168	12.331	0.655	-176.140
1350	0.804	-162.470	0.230	69.906	1.082	10.481	0.651	-173.319
1400	0.809	-159.531	0.240	67.648	1.008	9.729	0.658	-171.233
1450	0.816	-156.335	0.251	65.743	0.953	9.000	0.661	-169.940
1500	0.825	-153.305	0.259	63.341	0.902	8.358	0.668	-168.226

V_{DD}=13V, I_D=100mA

FREQ. (MHz)	S ₁₁		S ₁₂		S ₂₁		S ₂₂	
	Real	Imag	Real	Imag	Real	Imag	Real	Imag
50	0.969	-28.167	0.014	71.719	15.673	157.229	0.584	-25.160
100	0.895	-52.309	0.023	58.790	13.660	137.611	0.550	-46.574
150	0.818	-71.057	0.028	50.602	11.486	122.578	0.519	-62.601
200	0.766	-85.910	0.030	46.574	9.627	110.613	0.498	-75.182
250	0.731	-97.535	0.030	45.714	8.179	101.187	0.490	-84.524
300	0.713	-106.770	0.030	48.027	7.015	93.440	0.487	-91.913
350	0.699	-114.312	0.028	55.670	6.113	86.760	0.491	-98.343
400	0.691	-120.895	0.031	62.737	5.388	80.878	0.500	-103.694
450	0.694	-126.479	0.032	73.404	4.823	75.886	0.508	-107.961
500	0.692	-131.266	0.037	80.763	4.335	70.903	0.519	-112.507
550	0.694	-136.032	0.043	87.314	3.935	66.204	0.529	-116.209
600	0.698	-140.107	0.050	92.097	3.611	62.009	0.539	-120.031
650	0.705	-144.290	0.059	95.477	3.331	58.175	0.551	-123.436
700	0.711	-148.279	0.069	96.935	3.095	53.864	0.564	-126.986
750	0.714	-151.821	0.079	98.151	2.875	49.913	0.575	-130.446
800	0.719	-155.417	0.091	97.664	2.685	46.260	0.585	-134.470
850	0.731	-159.212	0.102	96.976	2.511	42.090	0.595	-137.974
900	0.735	-162.934	0.116	95.996	2.342	38.080	0.605	-141.841
950	0.745	-166.562	0.128	94.383	2.215	34.580	0.619	-145.830
1000	0.750	-170.178	0.142	92.828	2.064	30.750	0.623	-149.638
1050	0.757	-173.594	0.155	90.415	1.936	27.264	0.632	-153.862
1100	0.769	-177.132	0.168	87.874	1.817	23.902	0.642	-158.231
1150	0.775	-179.157	0.182	85.838	1.693	20.361	0.650	-161.799
1200	0.782	-175.539	0.195	82.989	1.585	17.461	0.653	-165.820
1250	0.793	-172.187	0.208	80.799	1.476	14.114	0.657	-169.544
1300	0.799	-169.041	0.221	78.268	1.360	11.831	0.656	-172.628
1350	0.807	-165.082	0.233	75.458	1.263	9.495	0.651	-176.074
1400	0.814	-162.211	0.243	72.924	1.163	8.102	0.659	-178.678
1450	0.816	-158.932	0.255	71.005	1.097	7.206	0.660	-179.809
1500	0.829	-155.796	0.264	68.509	1.039	6.401	0.668	-177.692



LittleDiode supplies new, hard to find or obsolete electronic components and semiconductors all over the world.

With over two million different components listed you are sure to find the part you need.

Feel free to visit us today at our online store:

LittleDiode.com

Looking forward to providing you with the best possible service.