

**Features**

- N channel
- Enhancement mode
- Temperature sensor with thyristor characteristic
- The drain pin is electrically shorted to the tab

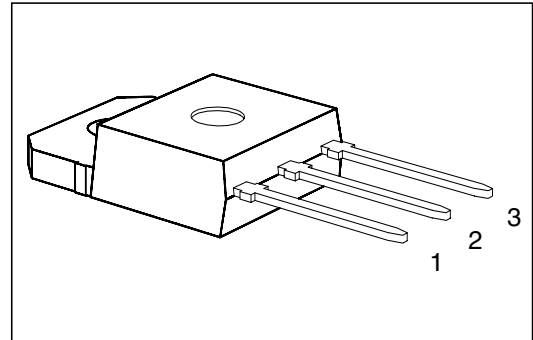

Pin	1	2	3
	G	D	S

Type	$V_{DS}$	$I_D$	$R_{DS(on)}$	Package	Ordering Code
BTS 240A	50 V	58 A	0.018 $\Omega$	TO-218AA	C67078-A5100-A3

**Maximum Ratings**

Parameter	Symbol	Values	Unit
Drain-source voltage	$V_{DS}$	50	V
Drain-gate voltage, $R_{GS} = 20 \text{ k}\Omega$	$V_{DGR}$	50	
Gate-source voltage	$V_{GS}$	$\pm 20$	
Continuous drain current, $T_C = 73 \text{ }^\circ\text{C}$	$I_D$	58	A
ISO drain current $T_C = 85 \text{ }^\circ\text{C}$ , $V_{GS} = 10 \text{ V}$ , $V_{DS} = 0.5 \text{ V}$	$I_{D-ISO}$	21.0	
Pulsed drain current, $T_C = 25 \text{ }^\circ\text{C}$	$I_{D \text{ puls}}$	232	
Short circuit current, $T_j = -55 \dots +150 \text{ }^\circ\text{C}$	$I_{SC}$	147	
Short circuit dissipation, $T_j = -55 \dots +150 \text{ }^\circ\text{C}$	$P_{SCmax}$	2200	W
Power dissipation	$P_{tot}$	170	
Operating and storage temperature range	$T_j, T_{stg}$	$-55 \dots +150$	$^\circ\text{C}$
DIN humidity category, DIN 40 040	–	E	–
IEC climatic category, DIN IEC 68-1	–	55/150/56	
Thermal resistance			K/W
Chip-case	$R_{th \text{ JC}}$	$\leq 0.74$	
Chip-ambient	$R_{th \text{ JA}}$	$\leq 45$	

**Electrical Characteristics**

 at  $T_j = 25\text{ °C}$ , unless otherwise specified.

Parameter	Symbol	Values			Unit
		min.	typ.	max.	

**Static Characteristics**

Drain-source breakdown voltage $V_{GS} = 0, I_D = 0.25\text{ mA}$	$V_{(BR)DSS}$	50	–	–	V
Gate threshold voltage $V_{GS} = V_{DS}, I_D = 1\text{ mA}$	$V_{GS(th)}$	2.5	3.0	3.5	
Zero gate voltage drain current $V_{GS} = 0\text{ V}, V_{DS} = 50\text{ V}$ $T_j = 25\text{ °C}$ $T_j = 125\text{ °C}$	$I_{DSS}$	– –	0.1 10	1.0 100	$\mu\text{A}$
Gate-source leakage current $V_{GS} = 20\text{ V}, V_{DS} = 0$ $T_j = 25\text{ °C}$ $T_j = 150\text{ °C}$	$I_{GSS}$	– –	10 2.0	100 4.0	nA $\mu\text{A}$
Drain-source on-state resistance $V_{GS} = 10\text{ V}, I_D = 47\text{ A}$	$R_{DS(on)}$	–	0.012	0.018	$\Omega$

**Dynamic Characteristics**

Forward transconductance $V_{DS} \geq 2 \times I_D \times R_{DS(on)max}, I_D = 47\text{ A}$	$g_{fs}$	20.0	43.0	–	S
Input capacitance $V_{GS} = 0, V_{DS} = 25\text{ V}, f = 1\text{ MHz}$	$C_{iss}$	–	2.9	4.3	nF
Output capacitance $V_{GS} = 0, V_{DS} = 25\text{ V}, f = 1\text{ MHz}$	$C_{oss}$	–	1.4	2.1	
Reverse transfer capacitance $V_{GS} = 0, V_{DS} = 25\text{ V}, f = 1\text{ MHz}$	$C_{rss}$	–	0.5	0.8	
Turn-on time $t_{on}$ , ( $t_{on} = t_{d(on)} + t_r$ ) $V_{CC} = 30\text{ V}, V_{GS} = 10\text{ V}, I_D = 3\text{ A}, R_{GS} = 50\text{ }\Omega$	$t_{d(on)}$	–	50	75	ns
	$t_r$	–	150	230	
Turn-off time $t_{off}$ , ( $t_{off} = t_{d(off)} + t_f$ ) $V_{CC} = 30\text{ V}, V_{GS} = 10\text{ V}, I_D = 3\text{ A}, R_{GS} = 50\text{ }\Omega$	$t_{d(off)}$	–	350	560	
	$t_f$	–	250	330	

**Electrical Characteristics (cont'd)**

 at  $T_j = 25\text{ °C}$ , unless otherwise specified.

Parameter	Symbol	Values			Unit
		min.	typ.	max.	

**Reverse Diode**

Continuous source current	$I_S$	–	–	58	A
Pulsed source current	$I_{SM}$	–	–	232	
Diode forward on-voltage $I_F = 58\text{ A}$ , $V_{GS} = 0\text{ V}$	$V_{SD}$	–	1.4	1.8	V
Reverse recovery time $I_F = I_S$ , $di_F/dt = 100\text{ A}/\mu\text{s}$ , $V_R = 30\text{ V}$	$t_{rr}$	–	100	–	ns
Reverse recovery charge $I_F = I_S$ , $di_F/dt = 100\text{ A}/\mu\text{s}$ , $V_R = 30\text{ V}$	$Q_{rr}$	–	0.3	–	$\mu\text{C}$

**Temperature Sensor**

Forward voltage $I_{TS(on)} = 10\text{ mA}$ , $T_j = -55 \dots +150\text{ °C}$ Sensor override, $t_p \leq 100\text{ }\mu\text{s}$ $T_j = -55 \dots +160\text{ °C}$	$V_{TS(on)}$	0.7	1.4	1.5	V
		–	–	10	
Forward current $T_j = -55 \dots +150\text{ °C}$ Sensor override, $t_p \leq 100\text{ }\mu\text{s}$ $T_j = -55 \dots +160\text{ °C}$	$I_{TS(on)}$	–	–	10	mA
		–	–	600	
Holding current, $V_{TS(off)} = 5\text{ V}$ , $T_j = 25\text{ °C}$ $T_j = 150\text{ °C}$	$I_H$	0.05 0.05	0.1 0.2	0.5 0.3	
Switching temperature $V_{TS} = 5\text{ V}$	$T_{TS(on)}$	150	–	–	$\text{°C}$
Turn-off time $V_{TS} = 5\text{ V}$ , $I_{TS(on)} = 2\text{ mA}$	$t_{off}$	0.5	–	2.5	$\mu\text{s}$

**Examples for short-circuit protection**

 at  $T_j = -55 \dots +150 \text{ }^\circ\text{C}$ , unless otherwise specified.

Parameter	Symbol	Examples			Unit
		1	2	–	
Drain-source voltage	$V_{DS}$	15	30	–	V
Gate-source voltage	$V_{GS}$	6.4	5.1	–	
Short-circuit current	$I_{SC}$	< 147	< 67	–	A
Short-circuit dissipation	$P_{SC}$	< 2200	< 2000	–	W
Response time $T_j = 25 \text{ }^\circ\text{C}$ , before short circuit	$t_{SC(off)}$	< 25	< 25	–	ms

**Short-circuit protection  $I_{SC} = f(V_{DS})$** 

 Parameter:  $V_{GS}$ 

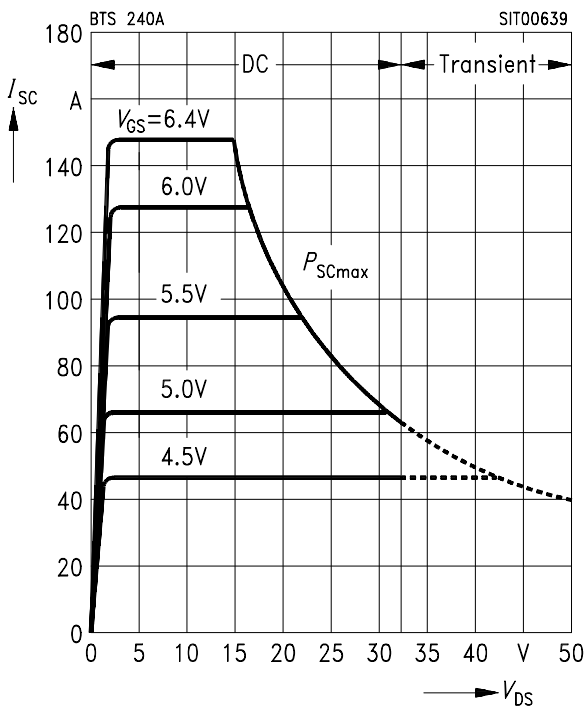
 Diagram to determine  $I_{SC}$  for  $T_j = -55 \dots +150 \text{ }^\circ\text{C}$ 

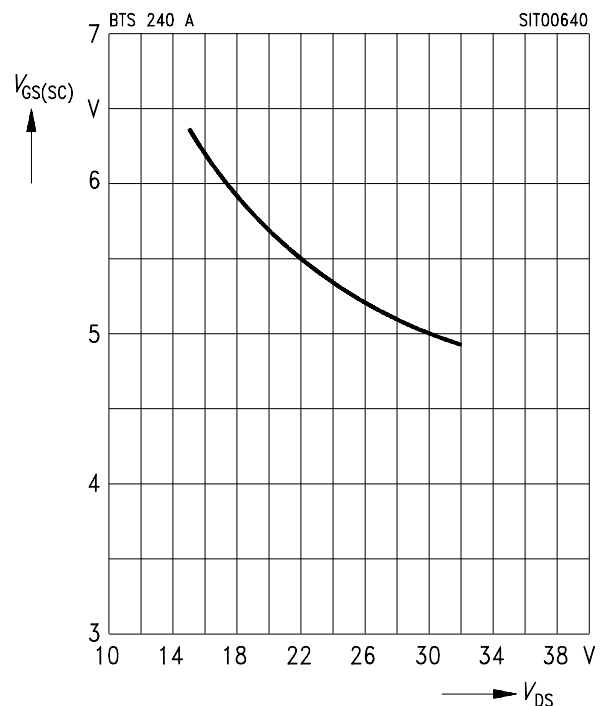
**Max. gate voltage  $V_{GS(SC)} = f(V_{DS})$** 

 Parameter:  $T_j = -55 \dots +150 \text{ }^\circ\text{C}$ 

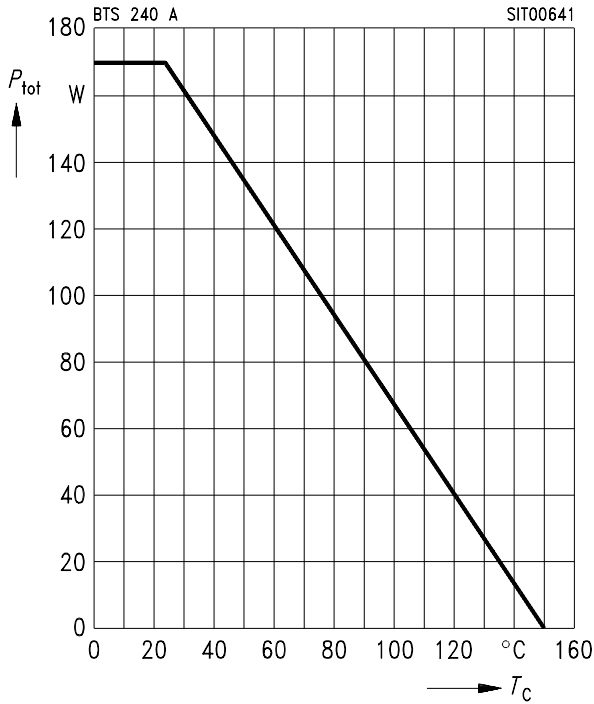
**Max. power dissipation  $P_{tot} = f(T_C)$**



**Typ. drain-source on-state resistance  $R_{DS(on)} = f(I_D)$**

Parameter:  $V_{GS}$

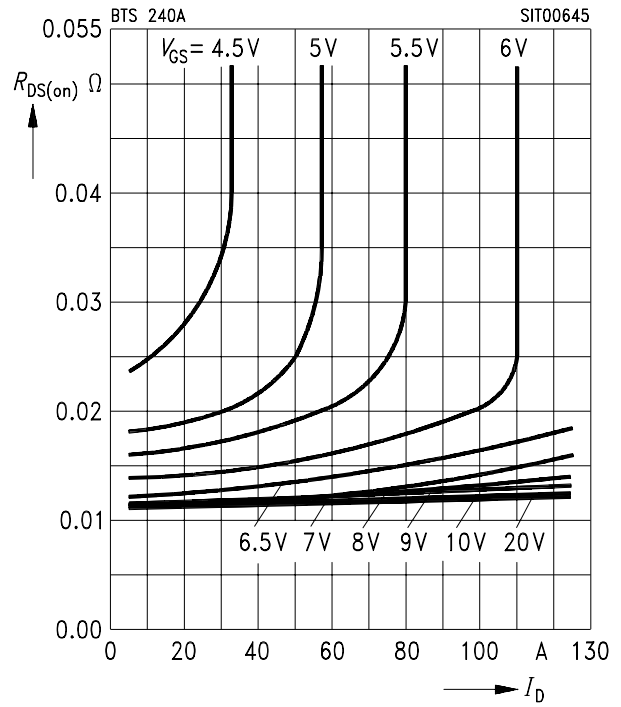

**Typical output characteristics  $I_D = f(V_{DS})$**

Parameter:  $t_p = 80 \mu s$

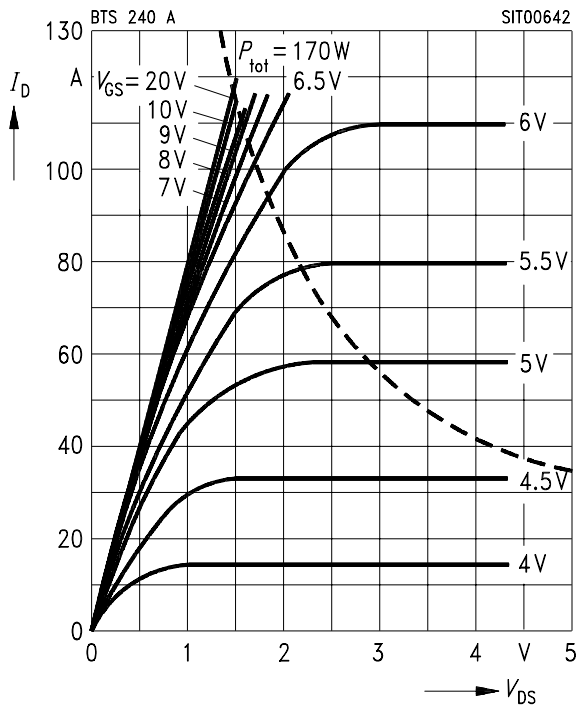

**Safe operating area  $I_D = f(V_{DS})$**

Parameter:  $D = 0.01, T_C = 25^\circ C$

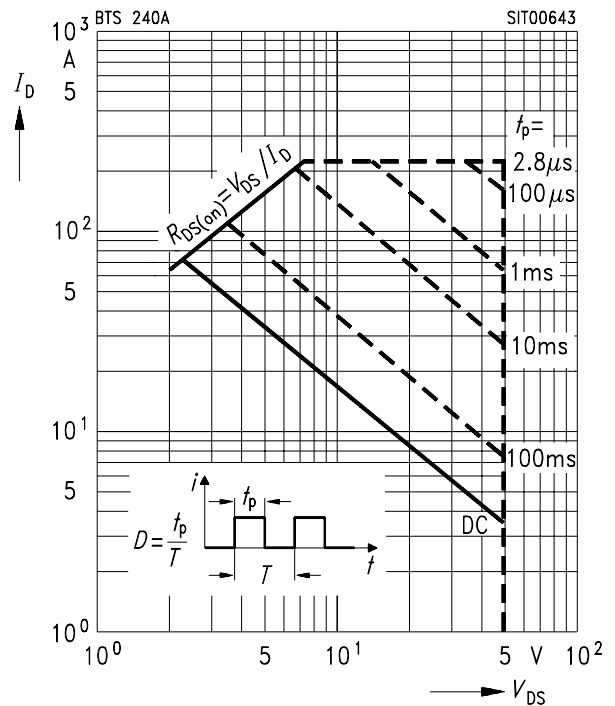

**Drain-source on-state resistance**

$R_{DS(on)} = f(T_j)$

Parameter:  $I_D = 47\text{ A}$ ,  $V_{GS} = 10\text{ V}$  (spread)

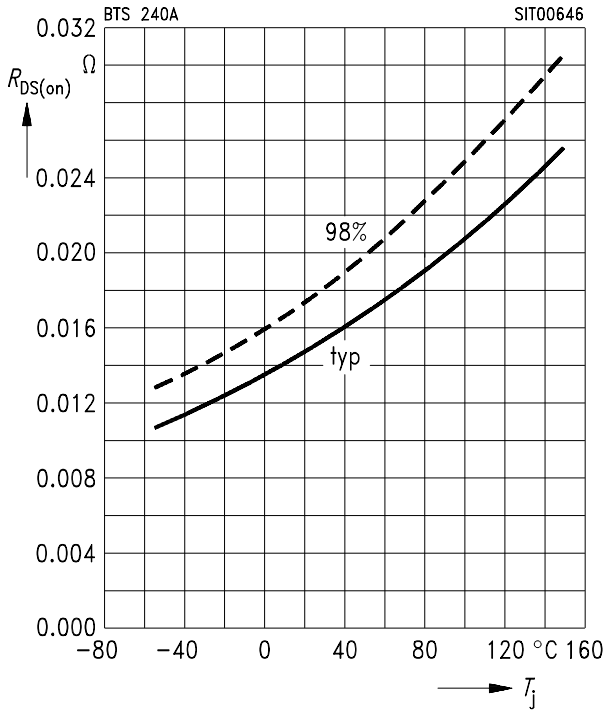

**Gate threshold voltage  $V_{GS(th)} = f(T_j)$**

Parameter:  $V_{DS} = V_{GS}$ ,  $I_D = 1\text{ mA}$

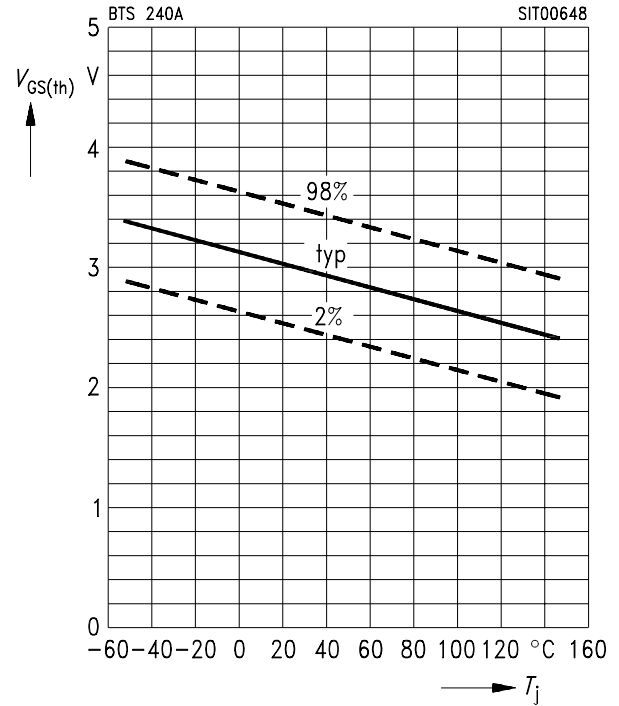

**Typ. transfer characteristic**

$I_D = f(V_{GS})$

Parameter:  $t_p = 80\text{ }\mu\text{s}$ ,  $V_{DS} = 25\text{ V}$

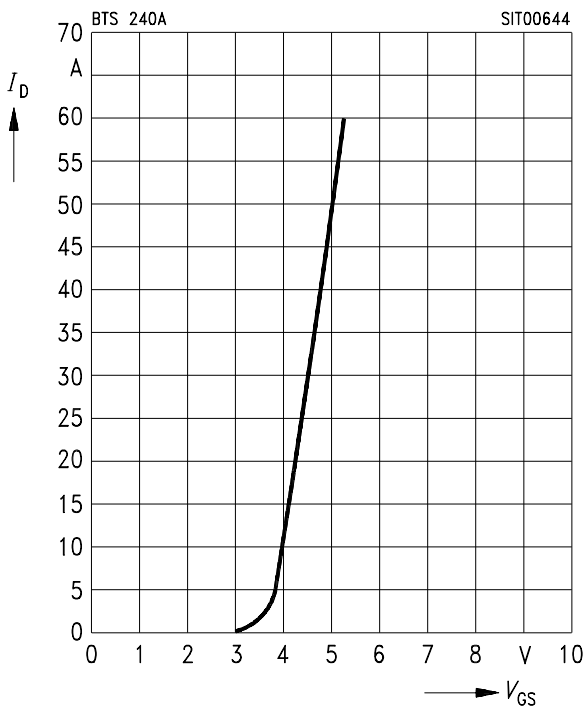

**Typ. transconductance  $g_{fs} = f(I_D)$**

Parameter:  $t_p = 80\text{ }\mu\text{s}$ ,  $V_{DS} = 25\text{ V}$

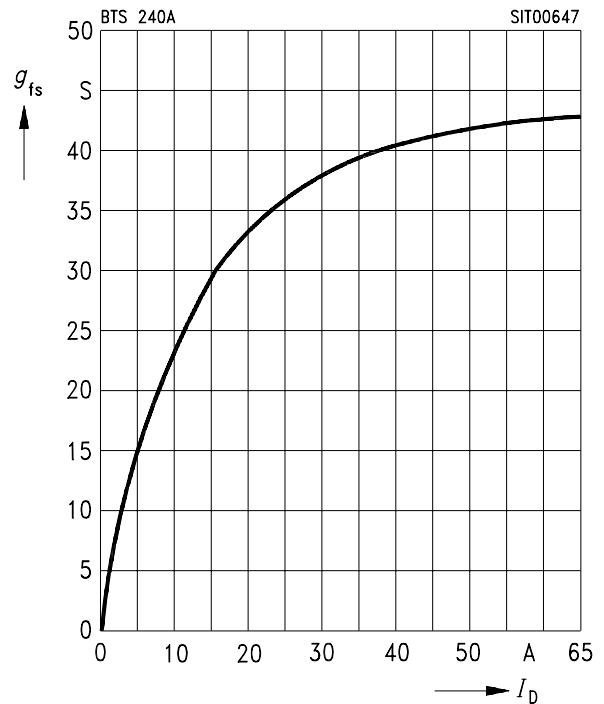

**Continuous drain current  $I_D = f(T_C)$**

Parameter:  $V_{GS} \geq 10\text{ V}$

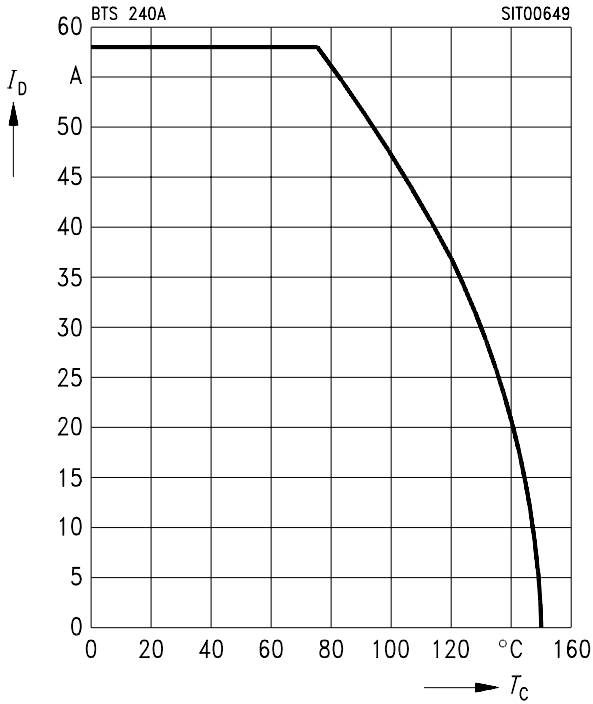

**Forward characteristics of reverse diode  $I_F = f(V_{SD})$**

Parameter:  $T_j, t_p = 80\ \mu\text{s}$  (spread)

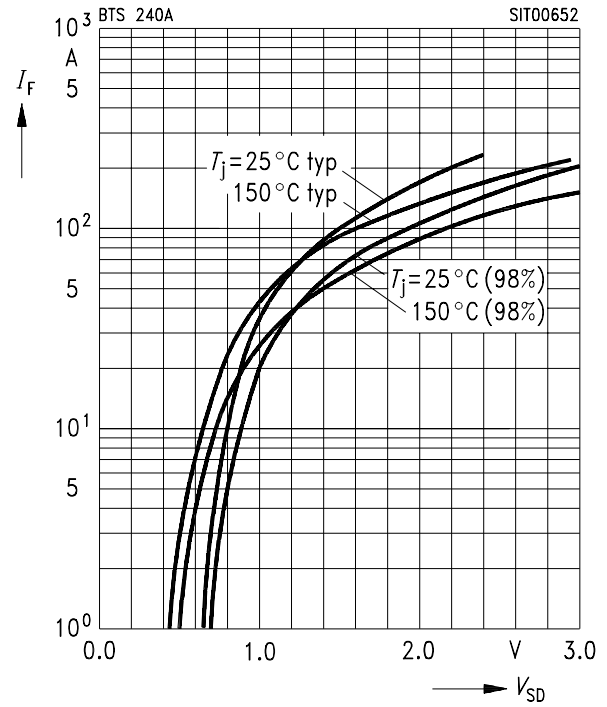

**Typ. gate-source leakage current  $I_{GSS} = f(T_C)$**

Parameter:  $V_{GS} = 20\text{ V}, V_{DS} = 0$

Parameter:  $V_{GS} = 20\text{ V}, V_{DS} = 0$

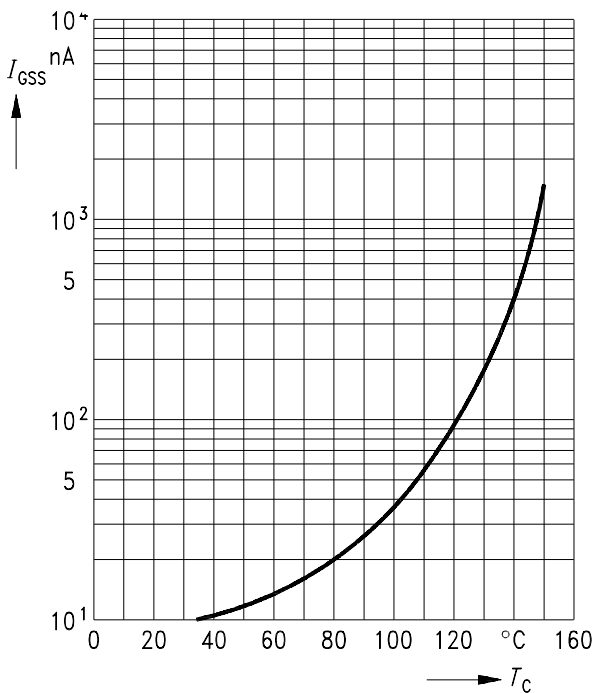

**Typ. capacitances  $C = f(V_{DS})$**

Parameter:  $V_{GS} = 0, f = 1\text{ MHz}$

Parameter:  $V_{GS} = 0, f = 1\text{ MHz}$

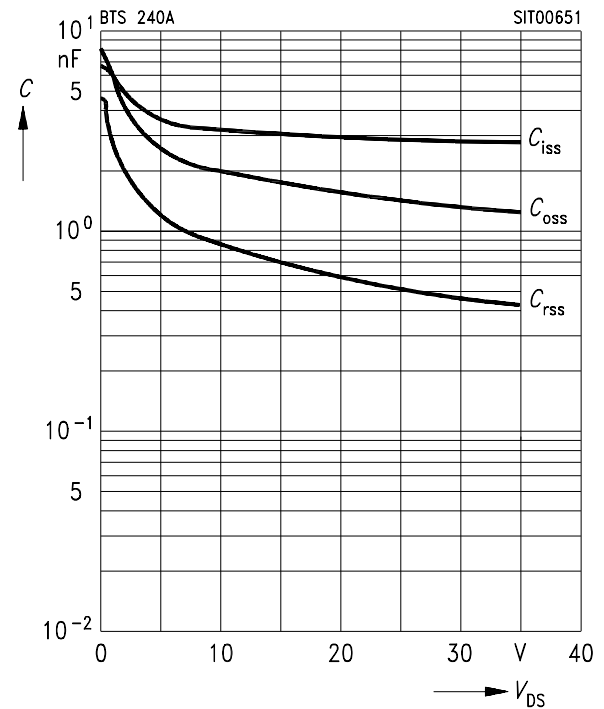

Transient thermal impedance  $Z_{thJC} = f(t_p)$   
 Parameter:  $D = t_p/T$

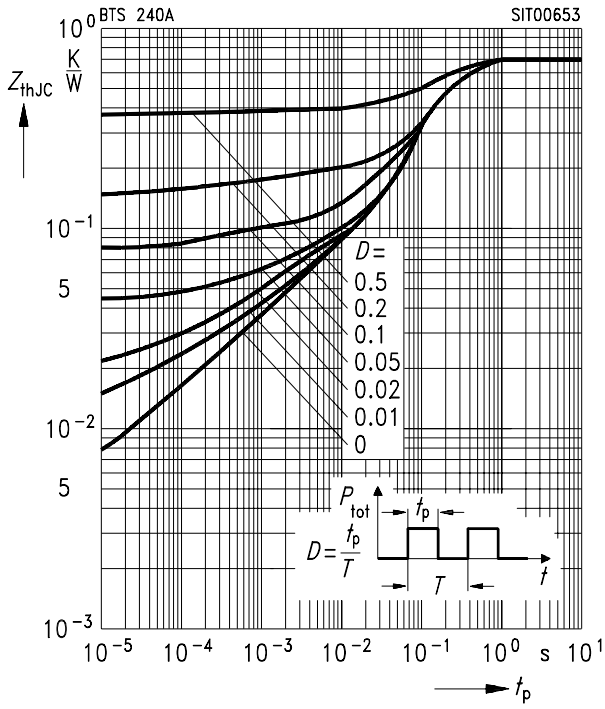



**Edition 04.97**

**Published by Infineon Technologies AG,  
St.-Martin-Strasse 53,  
D-81541 München, Germany**

**© Infineon Technologies AG 2000.  
All Rights Reserved.**

**Attention please!**

The information herein is given to describe certain components and shall not be considered as warranted characteristics.

Terms of delivery and rights to technical change reserved.

We hereby disclaim any and all warranties, including but not limited to warranties of non-infringement, regarding circuits, descriptions and charts stated herein.

Infineon Technologies is an approved CECC manufacturer.

**Information**

For further information on technology, delivery terms and conditions and prices please contact your nearest Infineon Technologies Office in Germany or our Infineon Technologies Representatives worldwide (see address list).

**Warnings**

Due to technical requirements components may contain dangerous substances. For information on the types in question please contact your nearest Infineon Technologies Office.

Infineon Technologies Components may only be used in life-support devices or systems with the express written approval of Infineon Technologies, if a failure of such components can reasonably be expected to cause the failure of that life-support device or system, or to affect the safety or effectiveness of that device or system. Life support devices or systems are intended to be implanted in the human body, or to support and/or maintain and sustain and/or protect human life. If they fail, it is reasonable to assume that the health of the user or other persons may be endangered.

This datasheet has been downloaded from:

[www.DatasheetCatalog.com](http://www.DatasheetCatalog.com)

Datasheets for electronic components.



LittleDiode supplies new, hard to find or obsolete electronic components and semiconductors all over the world.

With over two million different components listed you are sure to find the part you need.

Feel free to visit us today at our online store:

[LittleDiode.com](http://LittleDiode.com)

Looking forward to providing you with the best possible service.