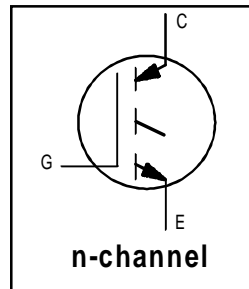


**Features**

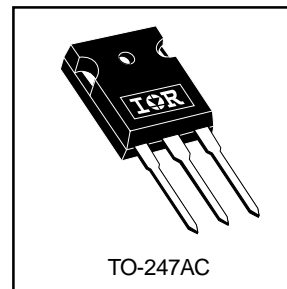
- UltraFast: Optimized for high operating frequencies 8-40 kHz in hard switching, >200 kHz in resonant mode
- Generation 4 IGBT design provides tighter parameter distribution and higher efficiency than Generation 3
- Industry standard TO-247AC package



$V_{CES} = 600V$
$V_{CE(on) typ.} = 1.65V$
@ $V_{GE} = 15V, I_C = 27A$

**Benefits**

- Generation 4 IGBT's offer highest efficiency available
- IGBT's optimized for specified application conditions
- Designed to be a "drop-in" replacement for equivalent industry-standard Generation 3 IR IGBT's



**Absolute Maximum Ratings**

	Parameter	Max.	Units
$V_{CES}$	Collector-to-Emitter Breakdown Voltage	600	V
$I_C @ T_C = 25^\circ C$	Continuous Collector Current	55	A
$I_C @ T_C = 100^\circ C$	Continuous Collector Current	27	
$I_{CM}$	Pulsed Collector Current ①	220	
$I_{LM}$	Clamped Inductive Load Current ②	220	
$V_{GE}$	Gate-to-Emitter Voltage	$\pm 20$	V
$E_{ARV}$	Reverse Voltage Avalanche Energy ③	20	mJ
$P_D @ T_C = 25^\circ C$	Maximum Power Dissipation	200	W
$P_D @ T_C = 100^\circ C$	Maximum Power Dissipation	78	
$T_J$	Operating Junction and Storage Temperature Range	-55 to + 150	°C
$T_{STG}$			
	Mounting torque, 6-32 or M3 screw.	10 lbf•in (1.1N•m)	

**Thermal Resistance**

	Parameter	Typ.	Max.	Units
$R_{\theta JC}$	Junction-to-Case	----	0.64	°C/W
$R_{\theta CS}$	Case-to-Sink, Flat, Greased Surface	0.24	----	
$R_{\theta JA}$	Junction-to-Ambient, typical socket mount	----	40	
Wt	Weight	6 (0.21)	----	

## Electrical Characteristics @ $T_J = 25^\circ\text{C}$ (unless otherwise specified)

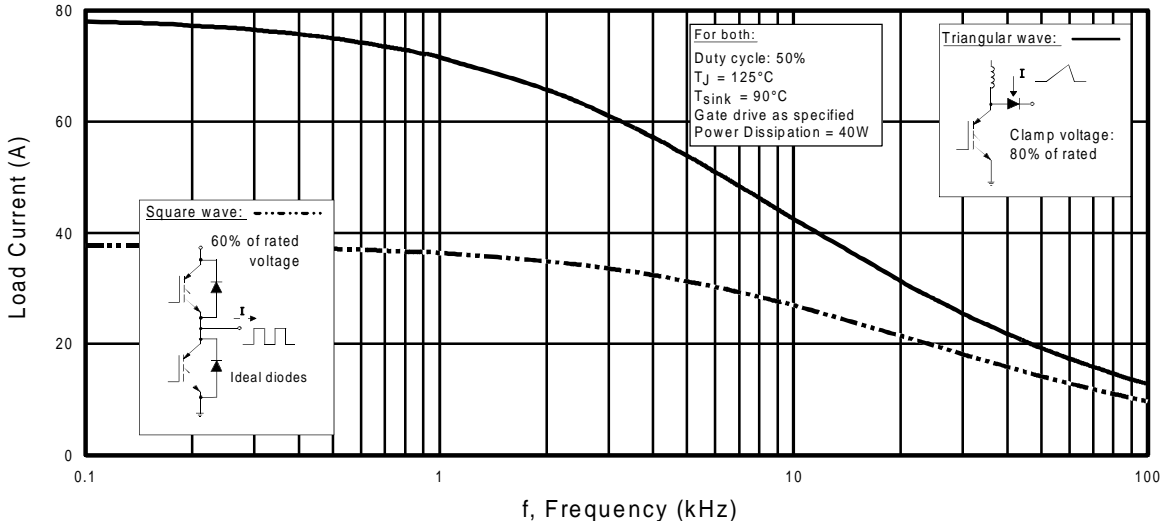
	Parameter	Min.	Typ.	Max.	Units	Conditions
$V_{(BR)CES}$	Collector-to-Emitter Breakdown Voltage	600	----	----	V	$V_{GE} = 0V, I_C = 250\mu A$
$V_{(BR)ECS}$	Emitter-to-Collector Breakdown Voltage ④	18	----	----	V	$V_{GE} = 0V, I_C = 1.0A$
$\Delta V_{(BR)CES}/\Delta T_J$	Temperature Coeff. of Breakdown Voltage	----	0.60	----	V/°C	$V_{GE} = 0V, I_C = 1.0mA$
$V_{CE(ON)}$	Collector-to-Emitter Saturation Voltage	----	1.65	2.0	V	$I_C = 27A$ $I_C = 55A$ $I_C = 27A, T_J = 150^\circ\text{C}$ $V_{GE} = 15V$ See Fig.2, 5
		----	2.0	----		
		----	1.6	----		
$V_{GE(th)}$	Gate Threshold Voltage	3.0	----	6.0		$V_{CE} = V_{GE}, I_C = 250\mu A$
$\Delta V_{GE(th)}/\Delta T_J$	Temperature Coeff. of Threshold Voltage	----	-13	----	mV/°C	$V_{CE} = V_{GE}, I_C = 250\mu A$
$g_{fe}$	Forward Transconductance ⑤	16	24	----	S	$V_{CE} \geq 15V, I_C = 27A$
$I_{CES}$	Zero Gate Voltage Collector Current	----	----	250	$\mu A$	$V_{GE} = 0V, V_{CE} = 600V$
		----	----	2.0		$V_{GE} = 0V, V_{CE} = 10V, T_J = 25^\circ\text{C}$
		----	----	5000		$V_{GE} = 0V, V_{CE} = 600V, T_J = 150^\circ\text{C}$
$I_{GES}$	Gate-to-Emitter Leakage Current	----	----	$\pm 100$	nA	$V_{GE} = \pm 20V$

## Switching Characteristics @ $T_J = 25^\circ\text{C}$ (unless otherwise specified)

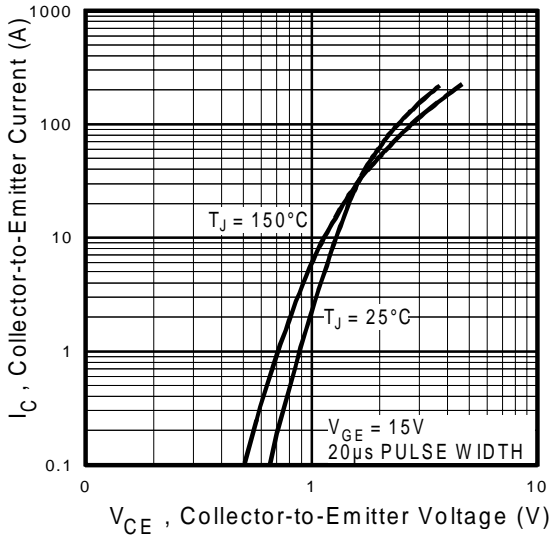
	Parameter	Min.	Typ.	Max.	Units	Conditions
$Q_g$	Total Gate Charge (turn-on)	----	180	270	nC	$I_C = 27A$ $V_{CC} = 400V$ $V_{GE} = 15V$ See Fig. 8
$Q_{ge}$	Gate - Emitter Charge (turn-on)	----	25	38		
$Q_{gc}$	Gate - Collector Charge (turn-on)	----	61	90		
$t_{d(on)}$	Turn-On Delay Time	----	32	----	ns	$T_J = 25^\circ\text{C}$ $I_C = 27A, V_{CC} = 480V$ $V_{GE} = 15V, R_G = 5.0\Omega$ Energy losses include "tail" See Fig. 10, 11, 13, 14
$t_r$	Rise Time	----	20	----		
$t_{d(off)}$	Turn-Off Delay Time	----	170	260		
$t_f$	Fall Time	----	88	130		
$E_{on}$	Turn-On Switching Loss	----	0.12	----	mJ	See Fig. 10, 11, 13, 14
$E_{off}$	Turn-Off Switching Loss	----	0.54	----		
$E_{ts}$	Total Switching Loss	----	0.66	0.9		
$t_{d(on)}$	Turn-On Delay Time	----	31	----	ns	$T_J = 150^\circ\text{C},$ $I_C = 27A, V_{CC} = 480V$ $V_{GE} = 15V, R_G = 5.0\Omega$ Energy losses include "tail" See Fig. 13, 14
$t_r$	Rise Time	----	23	----		
$t_{d(off)}$	Turn-Off Delay Time	----	230	----		
$t_f$	Fall Time	----	120	----		
$E_{ts}$	Total Switching Loss	----	1.6	----	mJ	
$L_E$	Internal Emitter Inductance	----	13	----	nH	Measured 5mm from package
$C_{ies}$	Input Capacitance	----	4000	----	pF	$V_{GE} = 0V$ $V_{CC} = 30V$ $f = 1.0MHz$ See Fig. 7
$C_{oes}$	Output Capacitance	----	250	----		
$C_{res}$	Reverse Transfer Capacitance	----	52	----		

### Notes:

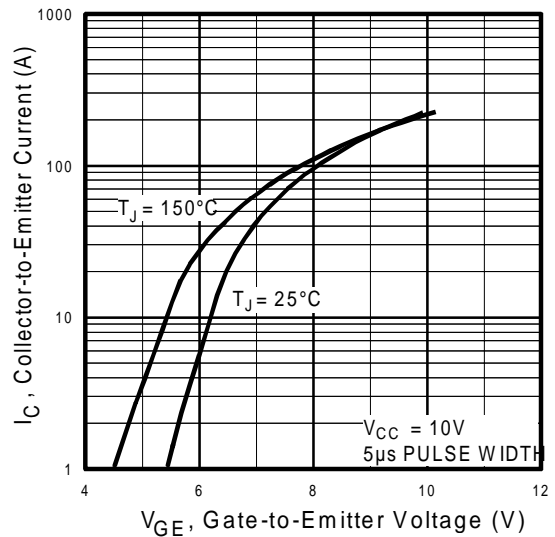
- ① Repetitive rating;  $V_{GE} = 20V$ , pulse width limited by max. junction temperature. ( See fig. 13b )
- ②  $V_{CC} = 80\%(V_{CES}), V_{GE} = 20V, L = 10\mu H, R_G = 5.0\Omega,$  (See fig. 13a)
- ③ Repetitive rating; pulse width limited by maximum junction temperature.
- ④ Pulse width  $\leq 80\mu s$ ; duty factor  $\leq 0.1\%$ .
- ⑤ Pulse width  $5.0\mu s$ , single shot.



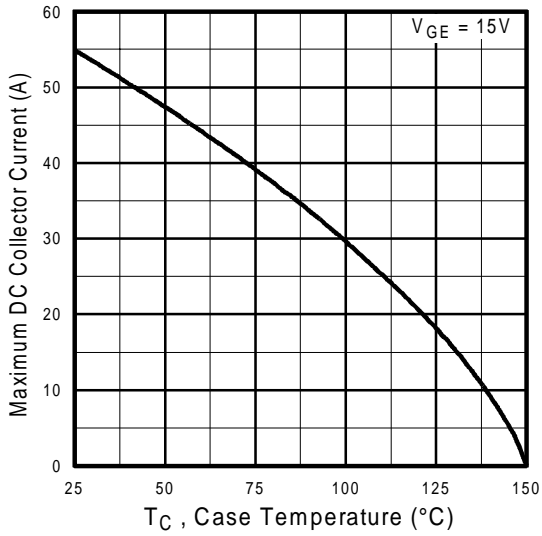
**Fig. 1 - Typical Load Current vs. Frequency**  
(For square wave,  $I = I_{RMS}$  of fundamental; for triangular wave,  $I = I_{PK}$ )



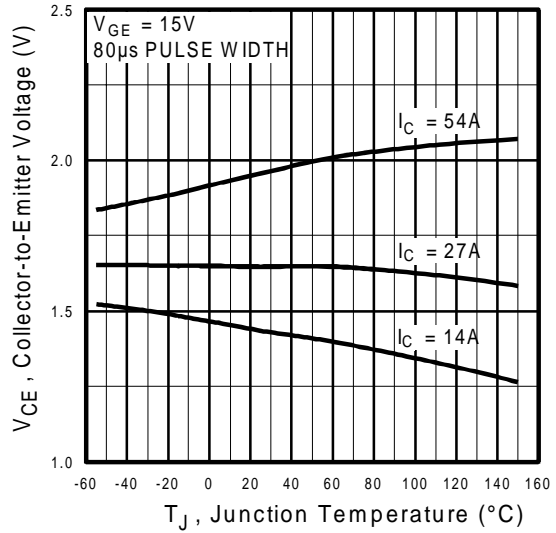
**Fig. 2 - Typical Output Characteristics**



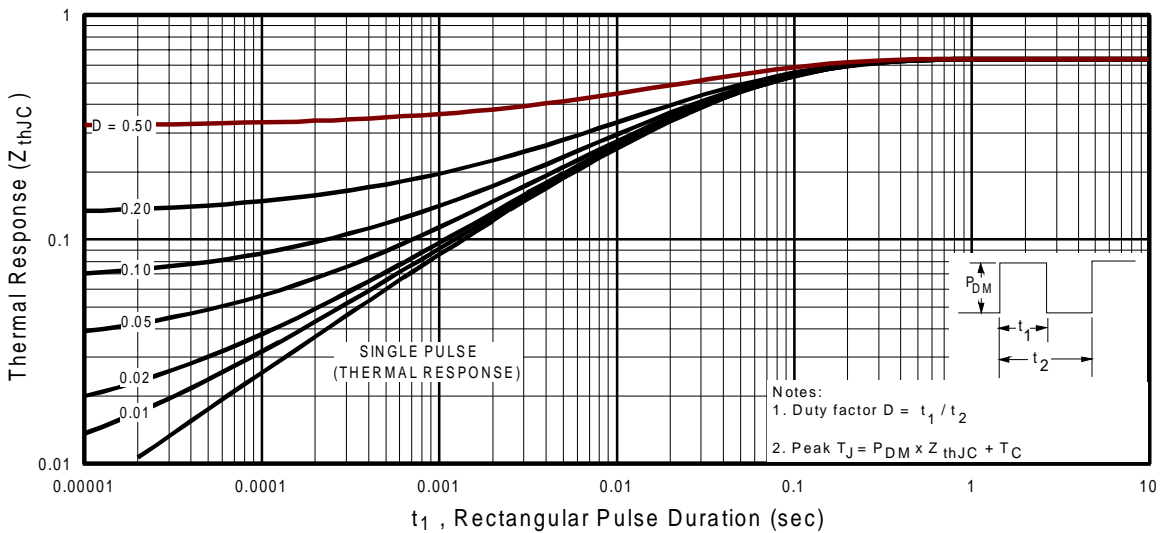
**Fig. 3 - Typical Transfer Characteristics**



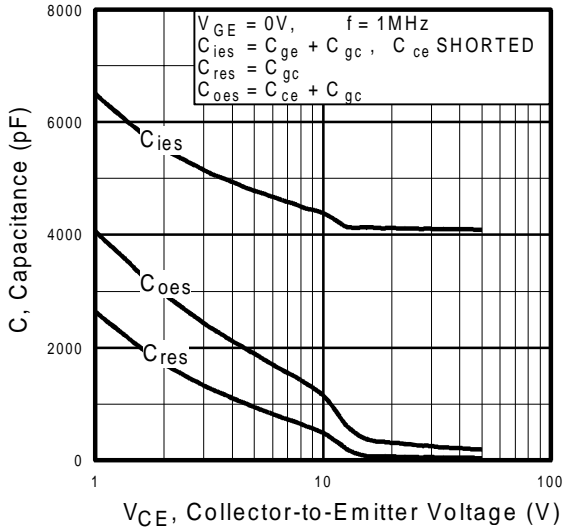
**Fig. 4** - Maximum Collector Current vs. Case Temperature



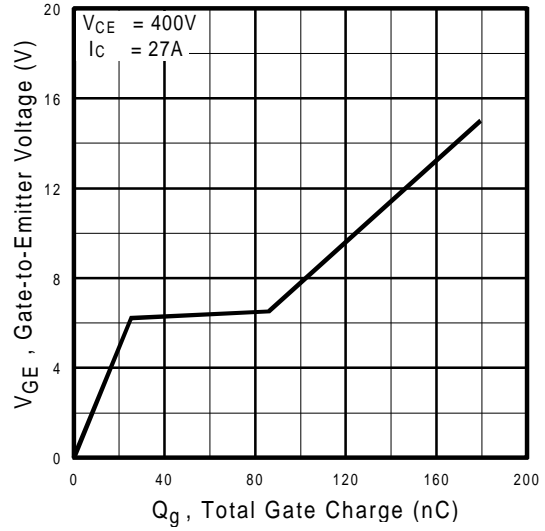
**Fig. 5** - Collector-to-Emitter Voltage vs. Junction Temperature



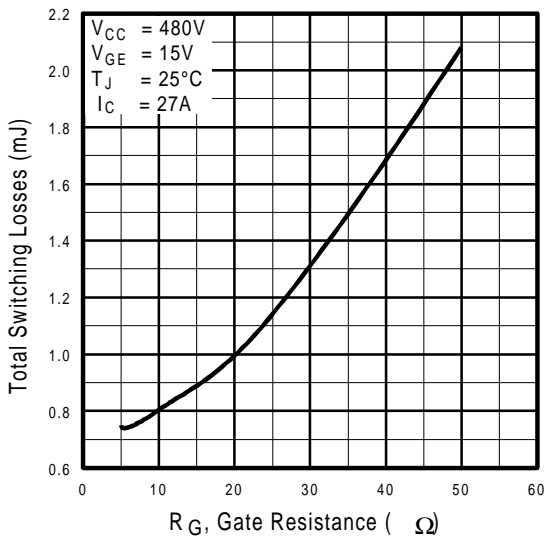
**Fig. 6** - Maximum Effective Transient Thermal Impedance, Junction-to-Case



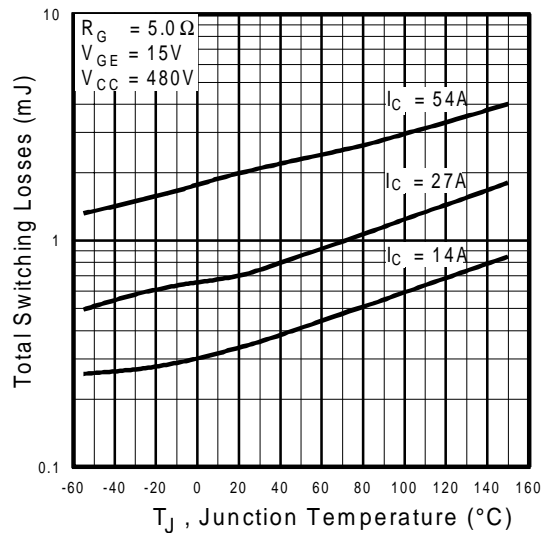
**Fig. 7** - Typical Capacitance vs. Collector-to-Emitter Voltage



**Fig. 8** - Typical Gate Charge vs. Gate-to-Emitter Voltage

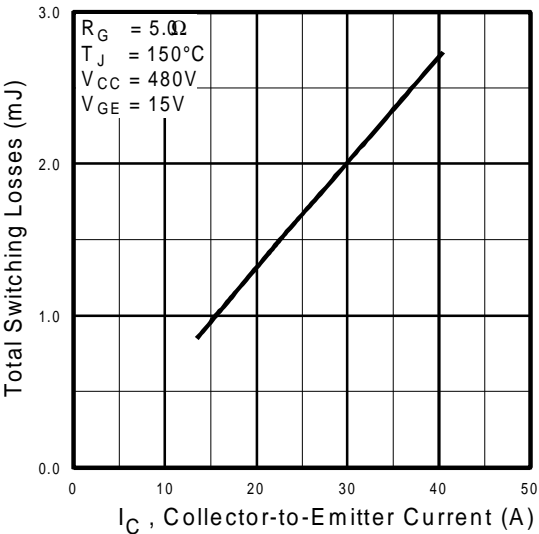


**Fig. 9** - Typical Switching Losses vs. Gate Resistance

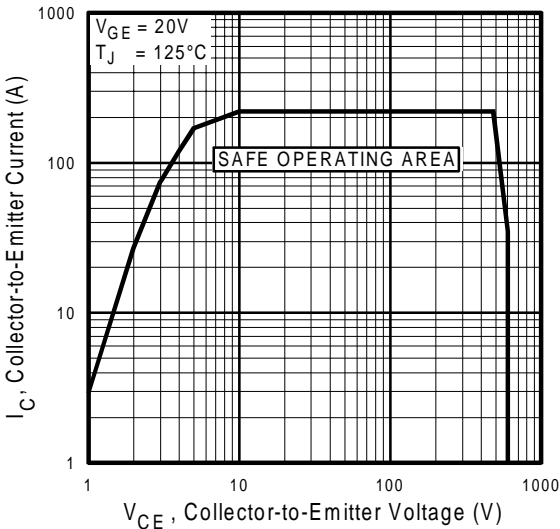


**Fig. 10** - Typical Switching Losses vs. Junction Temperature

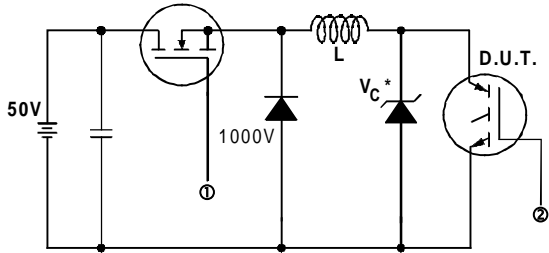
# IRG4PC50U



**Fig. 11** - Typical Switching Losses vs. Collector-to-Emitter Current

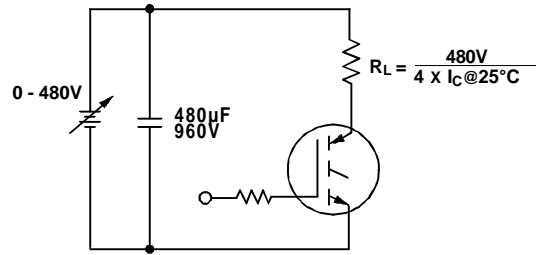


**Fig. 12** - Turn-Off SOA

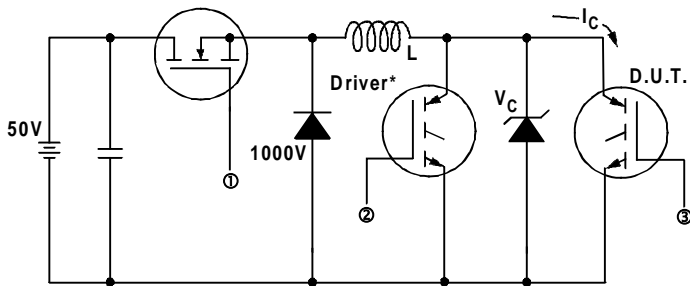


\* Driver same type as D.U.T.;  $V_c = 80\%$  of  $V_{ce(max)}$   
 \* Note: Due to the 50V power supply, pulse width and inductor will increase to obtain rated  $I_d$ .

**Fig. 13a** - Clamped Inductive Load Test Circuit

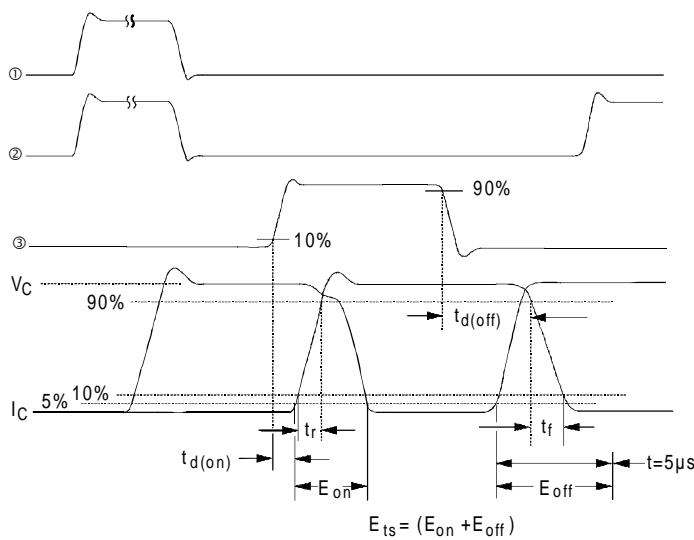


**Fig. 13b** - Pulsed Collector Current Test Circuit



**Fig. 14a** - Switching Loss Test Circuit

\* Driver same type as D.U.T.,  $V_C = 480V$

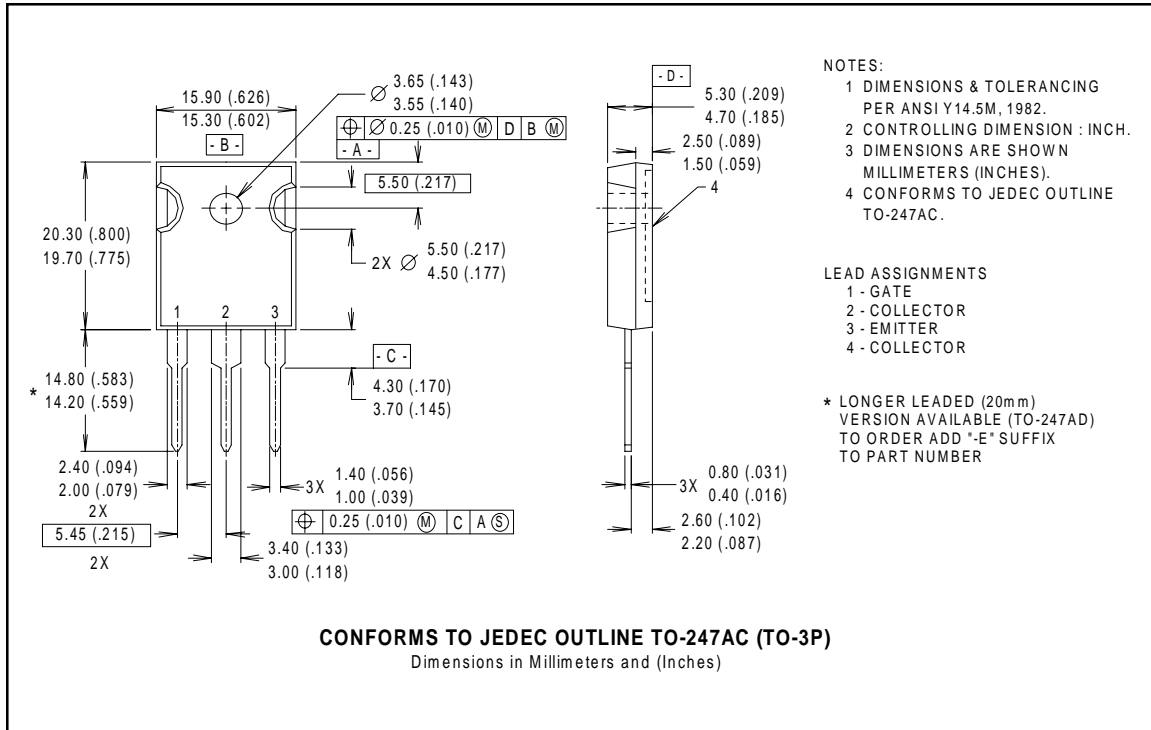


**Fig. 14b** - Switching Loss Waveforms

# IRG4PC50U

International  
**IR** Rectifier

## Case Outline and Dimensions — TO-247AC



International  
**IR** Rectifier

**IR WORLD HEADQUARTERS:** 233 Kansas St., El Segundo, California 90245, USA Tel: (310) 252-7105  
TAC Fax: (310) 252-7903

Visit us at [www.irf.com](http://www.irf.com) for sales contact information.  
Data and specifications subject to change without notice. 12/00



LittleDiode supplies new, hard to find or obsolete electronic components and semiconductors all over the world.

With over two million different components listed you are sure to find the part you need.

Feel free to visit us today at our online store:

[LittleDiode.com](http://LittleDiode.com)

Looking forward to providing you with the best possible service.