

## Fast Avalanche Sinterglass Diode

### Features

- Glass passivated junction
- Hermetically sealed package
- Low reverse current
- Soft recovery characteristics

### Applications

Very fast rectification and switching diodes

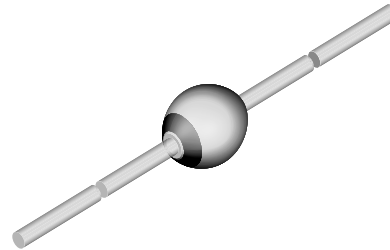

949539

### Mechanical Data

**Case:** SOD-57 Sintered glass case

**Terminals:** Plated axial leads, solderable per MIL-STD-750, Method 2026

**Polarity:** Color band denotes cathode end

**Mounting Position:** Any

**Weight:** approx. 369 mg

### Parts Table

Part	Type differentiation	Package
BYT54A	$V_R = 50 \text{ V}; I_{FAV} = 1.25 \text{ A}$	SOD-57
BYT54B	$V_R = 100 \text{ V}; I_{FAV} = 1.25 \text{ A}$	SOD-57
BYT54D	$V_R = 200 \text{ V}; I_{FAV} = 1.25 \text{ A}$	SOD-57
BYT54G	$V_R = 400 \text{ V}; I_{FAV} = 1.25 \text{ A}$	SOD-57
BYT54J	$V_R = 600 \text{ V}; I_{FAV} = 1.25 \text{ A}$	SOD-57
BYT54K	$V_R = 800 \text{ V}; I_{FAV} = 1.25 \text{ A}$	SOD-57
BYT54M	$V_R = 1000 \text{ V}; I_{FAV} = 1.25 \text{ A}$	SOD-57

### Absolute Maximum Ratings

$T_{amb} = 25 \text{ }^\circ\text{C}$ , unless otherwise specified

Parameter	Test condition	Part	Symbol	Value	Unit
Reverse voltage = Repetitive peak reverse voltage	see electrical characteristics	BYT54A	$V_R = V_{RRM}$	50	V
		BYT54B	$V_R = V_{RRM}$	100	V
		BYT54D	$V_R = V_{RRM}$	200	V
		BYT54G	$V_R = V_{RRM}$	400	V
		BYT54J	$V_R = V_{RRM}$	600	V
		BYT54K	$V_R = V_{RRM}$	800	V
		BYT54M	$V_R = V_{RRM}$	1000	V
Peak forward surge current	$t_p = 10 \text{ ms}$ , half sinewave		$I_{FSM}$	30	A

Parameter	Test condition	Part	Symbol	Value	Unit
Average forward current	on PC board		$I_{FAV}$	0.75	A
	$l = 10$ mm		$I_{FAV}$	1.25	A
Junction and storage temperature range		BYT54A	$T_j = T_{stg}$	- 55 to + 175	°C
		BYT54B	$T_j = T_{stg}$	- 55 to + 175	°C
		BYT54D	$T_j = T_{stg}$	- 55 to + 175	°C
		BYT54G	$T_j = T_{stg}$	- 55 to + 175	°C
		BYT54J	$T_j = T_{stg}$	- 55 to + 175	°C
		BYT54K	$T_j = T_{stg}$	- 55 to + 175	°C
Non repetitive reverse avalanche energy	$I_{(BR)R} = 0.4$ A	BYT54J	$E_R$	10	mJ
		BYT54K	$E_R$	10	mJ
		BYT54M	$E_R$	10	mJ

### Maximum Thermal Resistance

$T_{amb} = 25$  °C, unless otherwise specified

Parameter	Test condition	Symbol	Value	Unit
Junction ambient	$l = 10$ mm, $T_L = \text{constant}$	$R_{thJA}$	45	K/W
	on PC board with spacing 25 mm	$R_{thJA}$	100	K/W

### Electrical Characteristics

$T_{amb} = 25$  °C, unless otherwise specified

Parameter	Test condition	Symbol	Min	Typ.	Max	Unit
Forward voltage	$I_F = 1$ A	$V_F$			1.5	V
Reverse current	$V_R = V_{RRM}$	$I_R$			5	μA
	$V_R = V_{RRM}$ , $T_j = 150$ °C	$I_R$			150	μA
Reverse recovery time	$I_F = 0.5$ A, $I_R = 1$ A, $i_R = 0.25$ A	$t_{rr}$			100	ns

### Typical Characteristics ( $T_{amb} = 25$ °C unless otherwise specified)

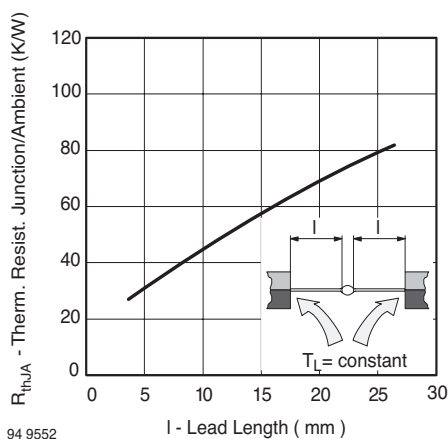

Figure 1. Max. Thermal Resistance vs. Lead Length

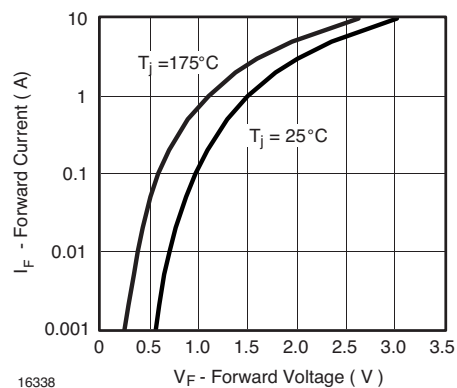

Figure 2. Forward Current vs. Forward Voltage

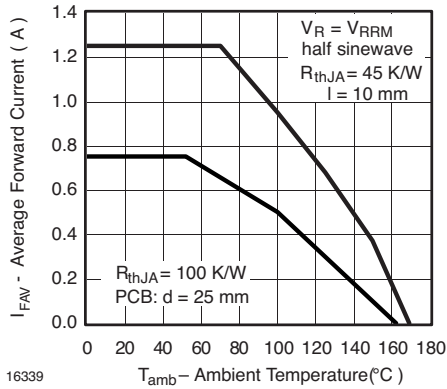

Figure 3. Max. Average Forward Current vs. Ambient Temperature

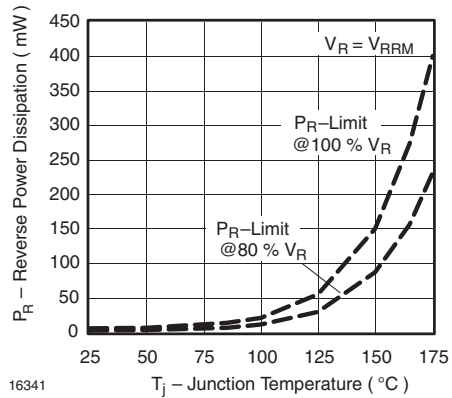

Figure 5. Max. Reverse Power Dissipation vs. Junction Temperature

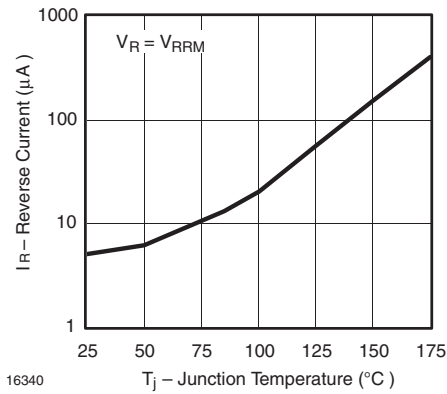

Figure 4. Reverse Current vs. Junction Temperature

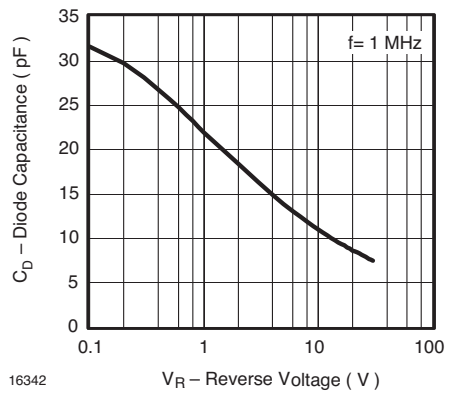
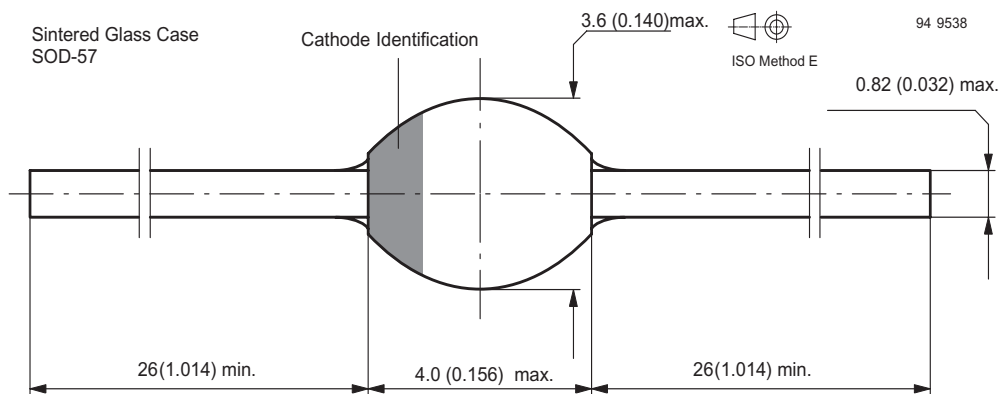

Figure 6. Diode Capacitance vs. Reverse Voltage

## Package Dimensions in mm (Inches)



## Vishay Semiconductors

### Ozone Depleting Substances Policy Statement

It is the policy of **Vishay Semiconductor GmbH** to

1. Meet all present and future national and international statutory requirements.
2. Regularly and continuously improve the performance of our products, processes, distribution and operating systems with respect to their impact on the health and safety of our employees and the public, as well as their impact on the environment.

It is particular concern to control or eliminate releases of those substances into the atmosphere which are known as ozone depleting substances (ODSs).

The Montreal Protocol (1987) and its London Amendments (1990) intend to severely restrict the use of ODSs and forbid their use within the next ten years. Various national and international initiatives are pressing for an earlier ban on these substances.

**Vishay Semiconductor GmbH** has been able to use its policy of continuous improvements to eliminate the use of ODSs listed in the following documents.

1. Annex A, B and list of transitional substances of the Montreal Protocol and the London Amendments respectively
2. Class I and II ozone depleting substances in the Clean Air Act Amendments of 1990 by the Environmental Protection Agency (EPA) in the USA
3. Council Decision 88/540/EEC and 91/690/EEC Annex A, B and C (transitional substances) respectively.

**Vishay Semiconductor GmbH** can certify that our semiconductors are not manufactured with ozone depleting substances and do not contain such substances.

**We reserve the right to make changes to improve technical design  
and may do so without further notice.**

Parameters can vary in different applications. All operating parameters must be validated for each customer application by the customer. Should the buyer use Vishay Semiconductors products for any unintended or unauthorized application, the buyer shall indemnify Vishay Semiconductors against all claims, costs, damages, and expenses, arising out of, directly or indirectly, any claim of personal damage, injury or death associated with such unintended or unauthorized use.

Vishay Semiconductor GmbH, P.O.B. 3535, D-74025 Heilbronn, Germany  
Telephone: 49 (0)7131 67 2831, Fax number: 49 (0)7131 67 2423



LittleDiode supplies new, hard to find or obsolete electronic components and semiconductors all over the world.

With over two million different components listed you are sure to find the part you need.

Feel free to visit us today at our online store:

[LittleDiode.com](http://LittleDiode.com)

Looking forward to providing you with the best possible service.