

# Insulated Gate Bipolar Transistor (IGBT)

**BUK856-800A**

## GENERAL DESCRIPTION

Fast-switching N-channel insulated gate bipolar power transistor in a plastic envelope.  
 The device is intended for use in motor control, DC/DC and AC/DC converters, and in general purpose high frequency switching applications.

## QUICK REFERENCE DATA

SYMBOL	PARAMETER	MAX.	UNIT
$V_{CE}$	Collector-emitter voltage	800	V
$I_C$	Collector current (DC)	24	A
$P_{tot}$	Total power dissipation	125	W
$V_{CEsat}$	Collector-emitter on-state voltage	3.5	V
$E_{off}$	Turn-off energy Loss	1.0	mJ

## PINNING - TO220AB

PIN	DESCRIPTION
1	gate
2	collector
3	emitter
tab	collector

## PIN CONFIGURATION

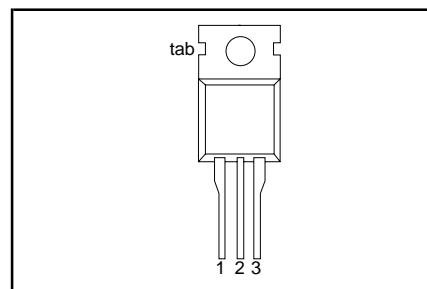

## SYMBOL

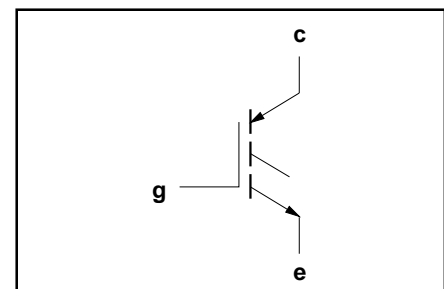

## LIMITING VALUES

Limiting values in accordance with the Absolute Maximum System (IEC 134)

SYMBOL	PARAMETER	CONDITIONS	MIN.	MAX.	UNIT
$V_{CE}$	Collector-emitter voltage	-	-5	800	V
$V_{CGR}$	Collector-gate voltage	$R_{GE} = 20\text{ k}\Omega$	-	800	V
$\pm V_{GE}$	Gate-emitter voltage	-	-	30	V
$I_C$	Collector current (DC)	$T_{mb} = 25\text{ }^\circ\text{C}$	-	24	A
$I_C$	Collector current (DC)	$T_{mb} = 100\text{ }^\circ\text{C}$	-	12	A
$I_{CLM}$	Collector Current (Clamped Inductive Load)	$T_j \leq T_{jmax.}$ $V_{CL} \leq 500\text{ V}$	-	40	A
$I_{CM}$	Collector current (pulsed peak value, on-state)	$T_j \leq T_{jmax.}$	-	50	A
$P_{tot}$	Total power dissipation	$T_{mb} = 25\text{ }^\circ\text{C}$	-	125	W
$T_{stg}$	Storage temperature	-	- 55	150	$^\circ\text{C}$
$T_j$	Junction Temperature	-	-	150	$^\circ\text{C}$

## THERMAL RESISTANCES

SYMBOL	PARAMETER	CONDITIONS	TYP.	MAX.	UNIT
$R_{th\ j-mb}$	Junction to mounting base	-	-	1.0	K/W
$R_{th\ j-a}$	Junction to ambient	In free air	60	-	K/W

## Insulated Gate Bipolar Transistor (IGBT)

BUK856-800A

**STATIC CHARACTERISTICS** $T_{mb} = 25\text{ }^{\circ}\text{C}$  unless otherwise specified

SYMBOL	PARAMETER	CONDITIONS	MIN.	TYP.	MAX.	UNIT
$V_{(BR)CES}$	Collector-emitter breakdown voltage	$V_{GE} = 0\text{ V}; I_C = 0.25\text{ mA}$	800	-	-	V
$V_{GE(TO)}$	Gate threshold voltage	$V_{CE} = V_{GE}; I_C = 1\text{ mA}$	3	4	5.5	V
$I_{CES}$	Zero gate voltage collector current	$V_{CE} = 800\text{ V}; V_{GE} = 0\text{ V}; T_j = 25\text{ }^{\circ}\text{C}$	-	10	200	$\mu\text{A}$
$I_{CES}$	Zero gate voltage collector current	$V_{CE} = 800\text{ V}; V_{GE} = 0\text{ V}; T_j = 125\text{ }^{\circ}\text{C}$	-	0.2	1	mA
$I_{ECS}$	Reverse collector current	$V_{CE} = -5\text{ V}; V_{GE} = 0\text{ V}$	-	0.1	5	mA
$I_{GES}$	Gate emitter leakage current	$V_{GE} = \pm 30\text{ V}; V_{CE} = 0\text{ V}$	-	10	100	nA
$V_{CEsat}$	Collector-emitter saturation voltage	$V_{GE} = 15\text{ V}; I_C = 12\text{ A}$	-	2.4	3.5	V
		$V_{GE} = 15\text{ V}; I_C = 24\text{ A}$	-	3.1	-	V

**DYNAMIC CHARACTERISTICS** $T_{mb} = 25\text{ }^{\circ}\text{C}$  unless otherwise specified

SYMBOL	PARAMETER	CONDITIONS	MIN.	TYP.	MAX.	UNIT
$g_{fe}$	Forward transconductance	$V_{CE} = 15\text{ V}; I_C = 6\text{ A}$	3	7	-	S
$C_{ies}$	Input capacitance	$V_{GE} = 0\text{ V}; V_{CE} = 25\text{ V}; f = 1\text{ MHz}$	-	900	1250	pF
$C_{oes}$	Output capacitance		-	85	120	pF
$C_{res}$	Feedback capacitance		-	30	50	pF
$t_{don}$	Turn-on delay time	$I_C = 12\text{ A}; V_{CC} = 500\text{ V};$ $V_{GE} = 15\text{ V}; R_G = 25\Omega;$ $T_j = 25\text{ }^{\circ}\text{C};$	-	25	-	ns
$t_r$	Turn-on rise time		-	45	-	ns
$E_{on}$	Turn-on Energy Loss		-	0.6	-	mJ
$t_{doff}$	Turn-off delay time	Inductive Load Energy Losses include all 'tail' losses	-	230	350	ns
$t_f$	Turn-off fall time		-	200	400	ns
$E_{off}$	Turn-off Energy Loss		-	0.5	1	mJ
$t_{don}$	Turn-on delay time	$I_C = 12\text{ A}; V_{CC} = 500\text{ V};$ $V_{GE} = 15\text{ V}; R_G = 25\Omega;$ $T_j = 125\text{ }^{\circ}\text{C};$	-	25	-	ns
$t_r$	Turn-on rise time		-	45	-	ns
$E_{on}$	Turn-on Energy Loss		-	0.6	-	mJ
$t_{doff}$	Turn-off delay time	Inductive Load Energy Losses include all 'tail' losses	-	300	450	ns
$t_f$	Turn-off fall time		-	400	800	ns
$E_{off}$	Turn-off Energy Loss		-	1	2	mJ

Insulated Gate Bipolar Transistor (IGBT)

BUK856-800A

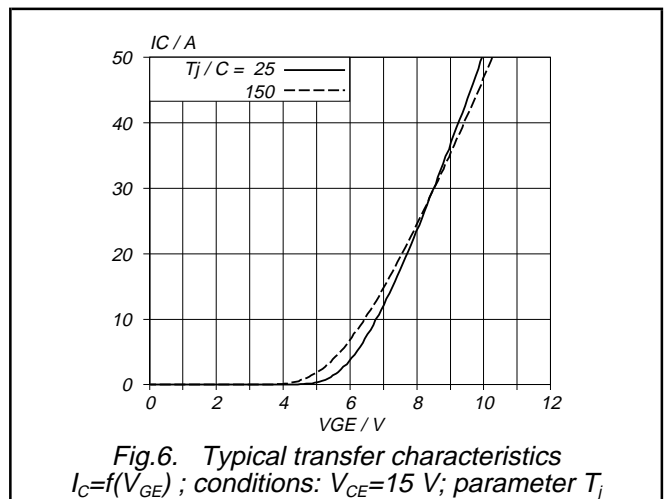
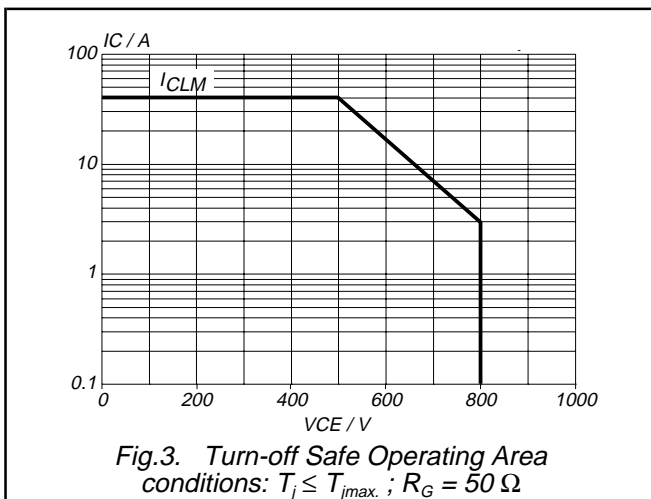
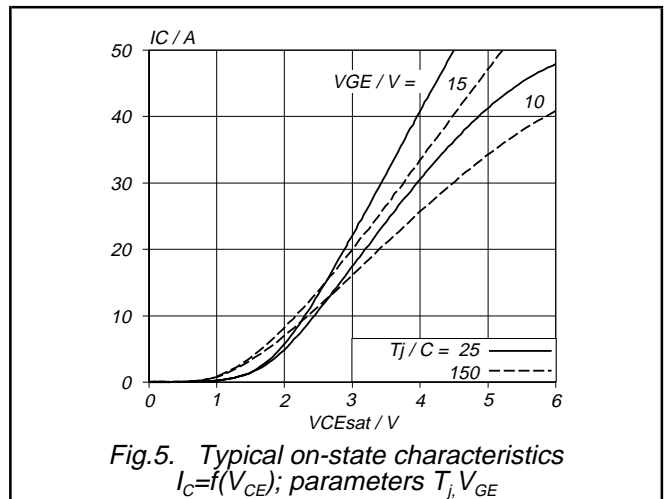
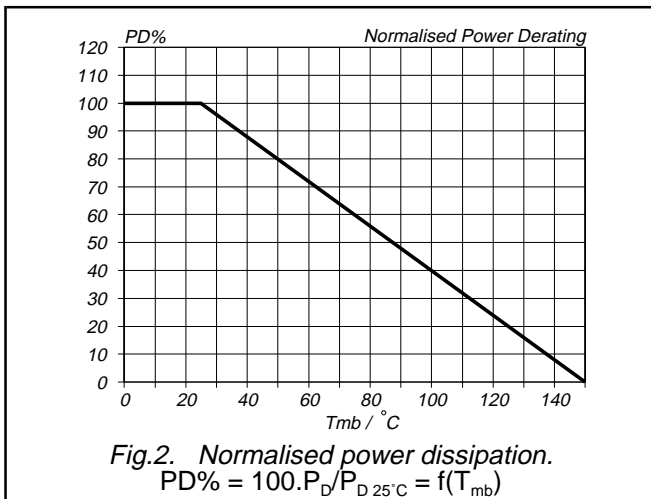
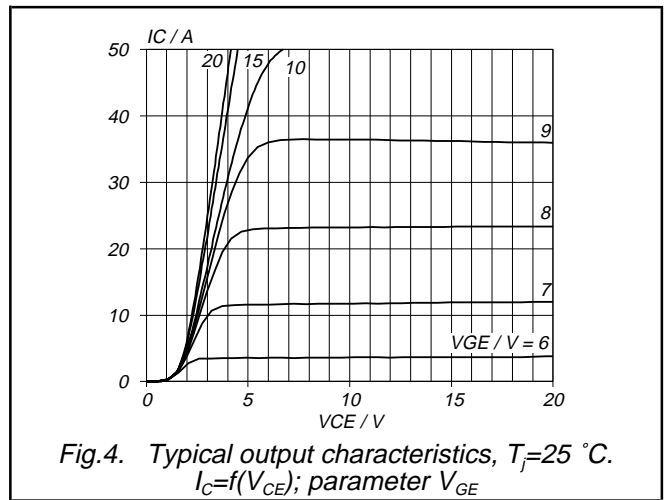
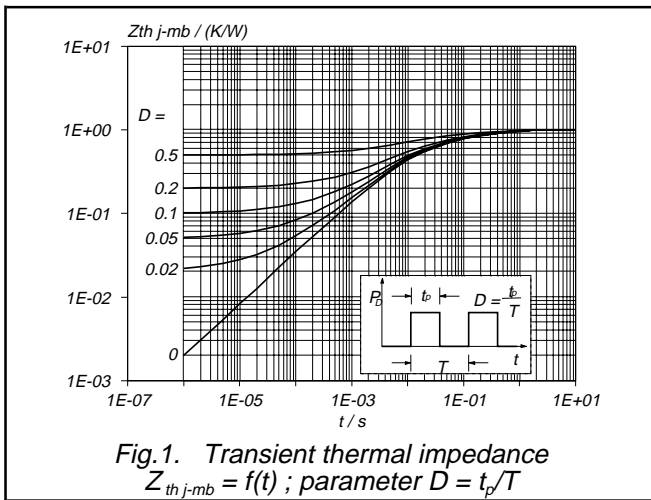

Insulated Gate Bipolar Transistor (IGBT)

BUK856-800A

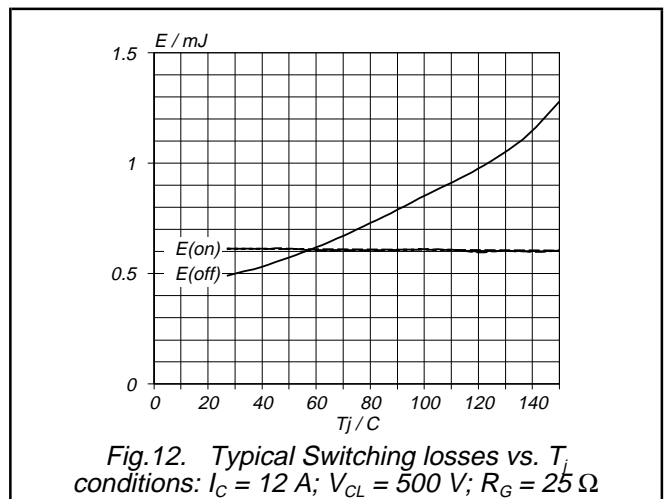
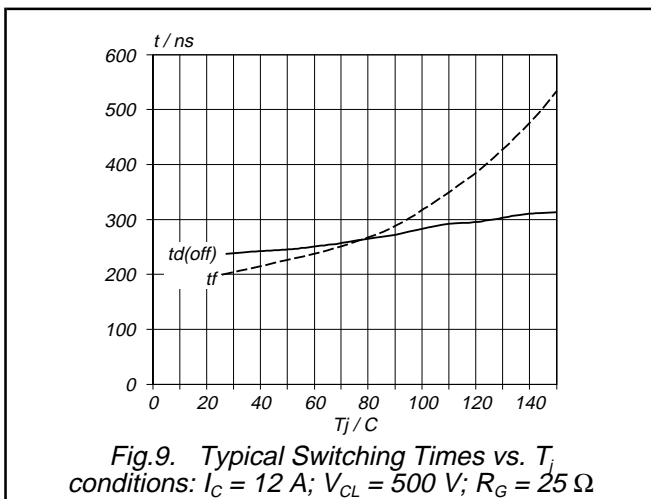
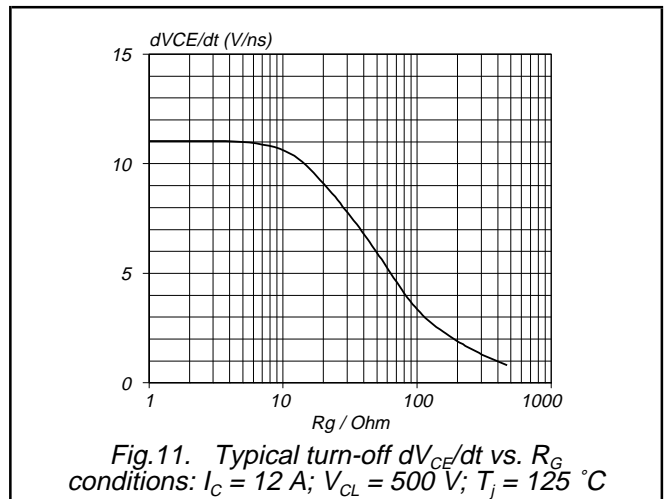
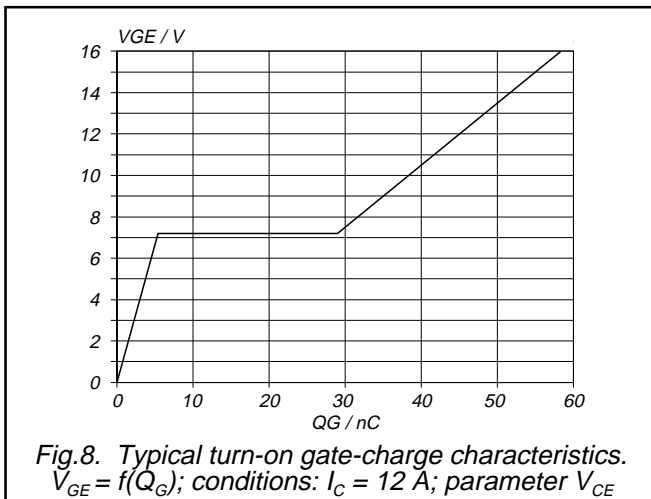
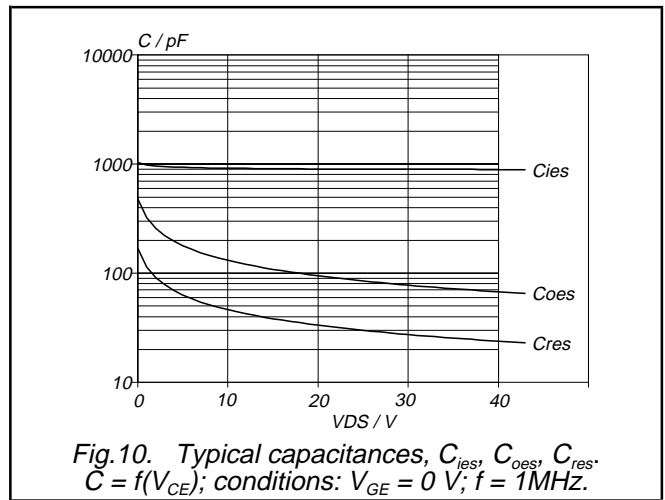
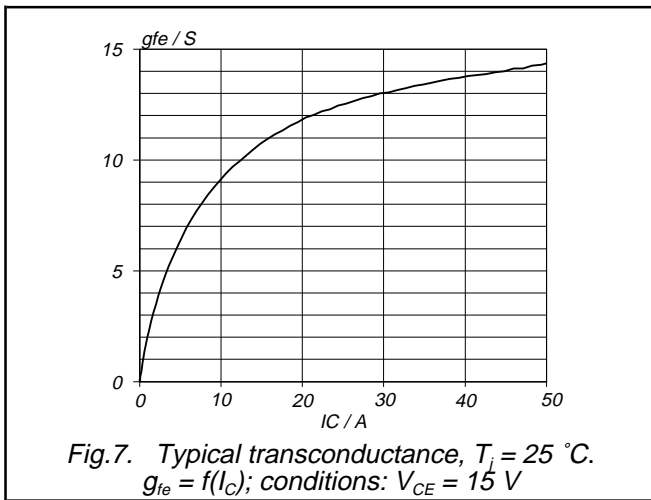

Insulated Gate Bipolar Transistor (IGBT)

BUK856-800A

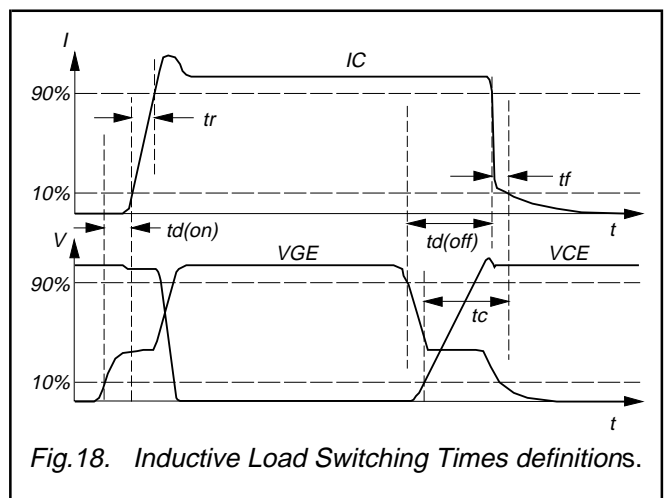
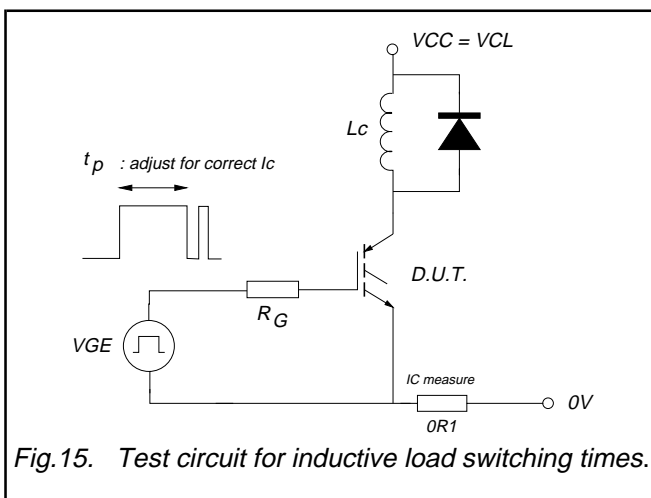
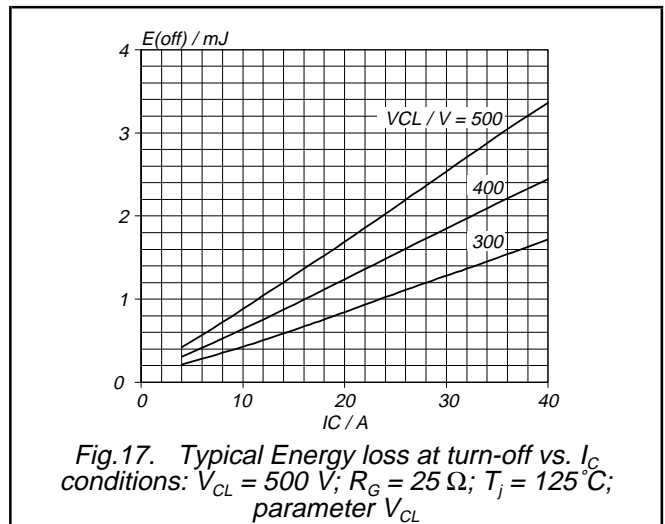
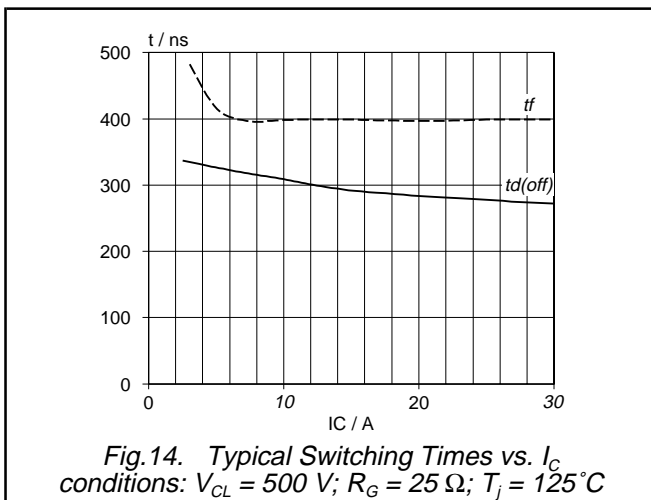
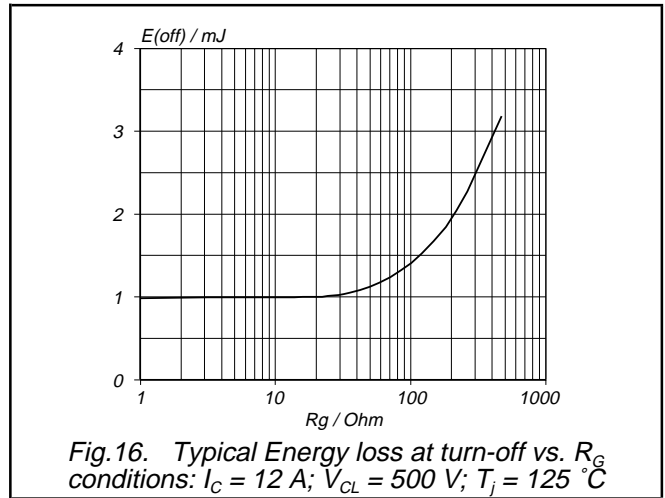
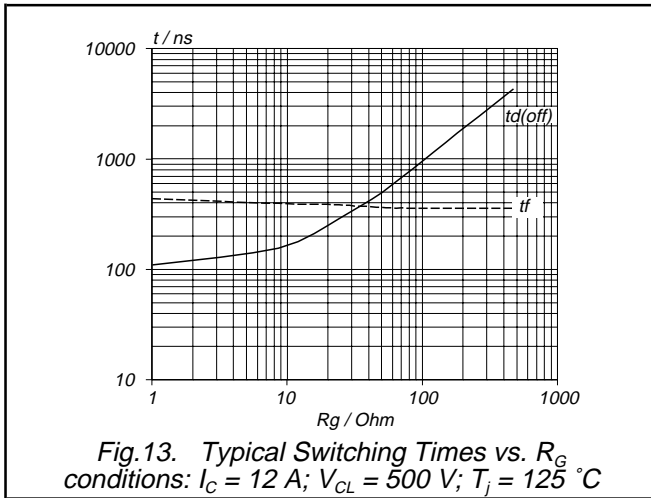

**MECHANICAL DATA**

*Dimensions in mm*

*Net Mass: 2 g*

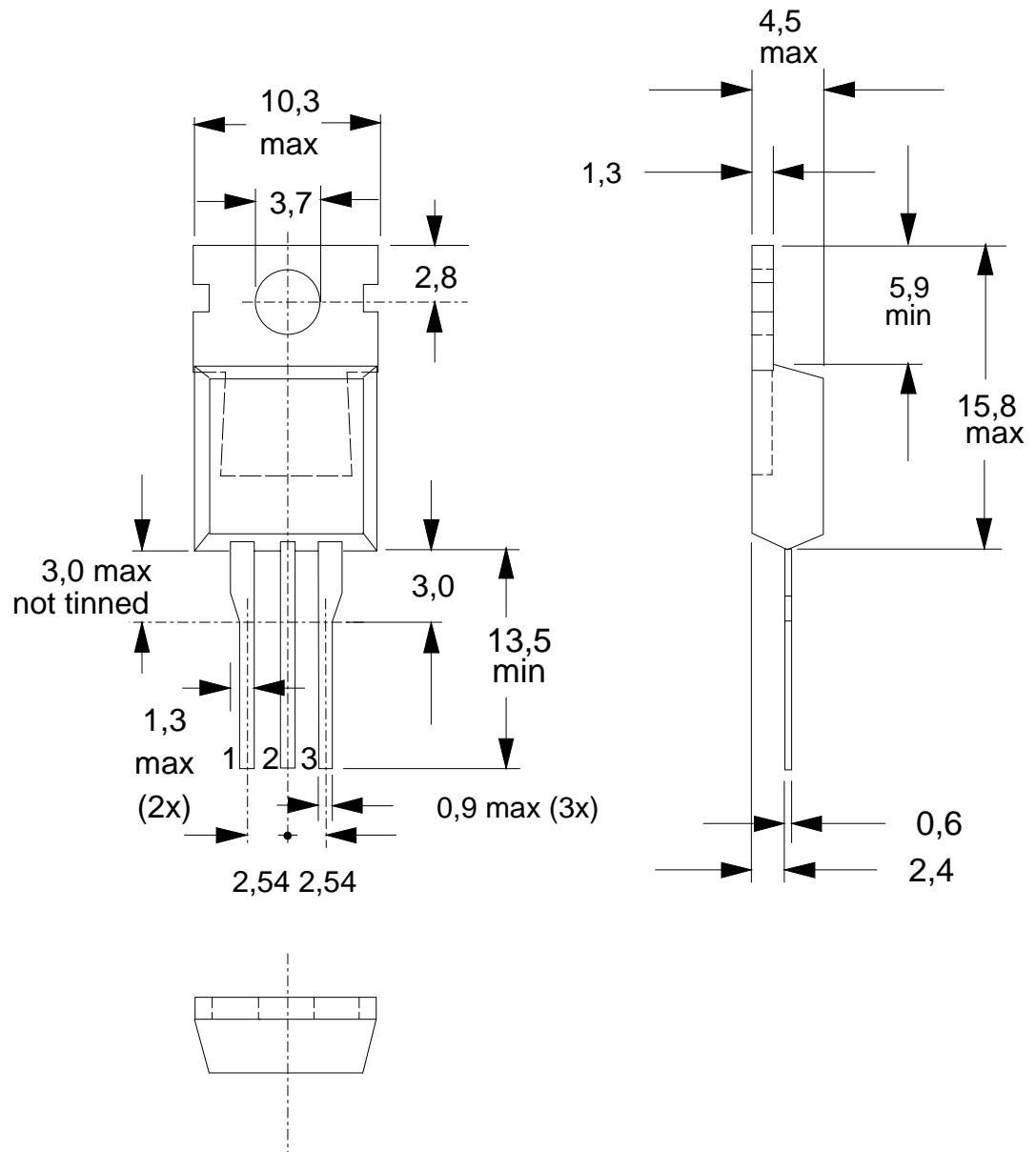

Fig.19. TO220AB; pin 2 connected to mounting base.

**Notes**

1. Observe the general handling precautions for electrostatic-discharge sensitive devices (ESDs) to prevent damage to MOS gate oxide.
2. Refer to mounting instructions for TO220 envelopes.
3. Epoxy meets UL94 V0 at 1/8".

## Insulated Gate Bipolar Transistor (IGBT)

BUK856-800A

**DEFINITIONS**

<b>Data sheet status</b>	
Objective specification	This data sheet contains target or goal specifications for product development.
Preliminary specification	This data sheet contains preliminary data; supplementary data may be published later.
Product specification	This data sheet contains final product specifications.
<b>Limiting values</b>	
Limiting values are given in accordance with the Absolute Maximum Rating System (IEC 134). Stress above one or more of the limiting values may cause permanent damage to the device. These are stress ratings only and operation of the device at these or at any other conditions above those given in the Characteristics sections of this specification is not implied. Exposure to limiting values for extended periods may affect device reliability.	
<b>Application information</b>	
Where application information is given, it is advisory and does not form part of the specification.	
© Philips Electronics N.V. 1996	
All rights are reserved. Reproduction in whole or in part is prohibited without the prior written consent of the copyright owner.	
The information presented in this document does not form part of any quotation or contract, it is believed to be accurate and reliable and may be changed without notice. No liability will be accepted by the publisher for any consequence of its use. Publication thereof does not convey nor imply any license under patent or other industrial or intellectual property rights.	

**LIFE SUPPORT APPLICATIONS**

These products are not designed for use in life support appliances, devices or systems where malfunction of these products can be reasonably expected to result in personal injury. Philips customers using or selling these products for use in such applications do so at their own risk and agree to fully indemnify Philips for any damages resulting from such improper use or sale.



LittleDiode supplies new, hard to find or obsolete electronic components and semiconductors all over the world.

With over two million different components listed you are sure to find the part you need.

Feel free to visit us today at our online store:

[LittleDiode.com](http://LittleDiode.com)

Looking forward to providing you with the best possible service.